

collections

21

**catalogo
generale**

general catalogue
catalogue général
Gesamtkatalog
общий каталог

Index A-Z

INDICE A-Z - INDEX A-Z

VERZEICHNIS IN ALPHABETISCHER REIHENFOLGE

АЛФАВИТНЫЙ УКАЗАТЕЛЬ

222	alpi
246	alpi grip 2CM
24	artica
30	artica roc
248	artica roc 2CM
108	borgate fiorentine
34	boulevard
110	brera
188	cave
206	cave roc
114	concreta
38	cosmos
118	cottoantico
122	cottocemento
208	cremo
44	district
48	district roc
50	eternity
130	ferrocemento
54	frammenta
58	frammenta roc
250	frammenta roc 2CM
60	galapagos
142	global
236	i colori
152	icon
162	icon roc
252	icon grip 2CM
62	kaleido
74	kaleido roc
164	logica
78	luserna
82	luserna roc
86	morestone
168	neutra
254	neutra roc 2CM
228	painted
90	phoenix
176	salento
210	shine
94	titano
256	titano grip 2CM
230	tundra
178	urbandeck
258	urbandeck grip 2CM
182	valencia
102	volcano
262	160x320 12mm

Look index

INDICE PER ASPETTO - INDEX PAR ASPECT
VERZEICHNIS NACH OPTIK - УКАЗАТЕЛЬ DESIGN

stone effect

EFFETTO PIETRA
IMITATION PIERRE
STEINEFFEKT / КАМЕНЬ

24	artica
30	artica roc
34	boulevard
38	cosmos
44	district
48	district roc
50	eternity
54	frammenta
58	frammenta roc
60	galapagos
62	kaleido
74	kaleido roc
78	luserna
82	luserna roc
86	morestone
90	phoenix
94	titano
102	volcano

concrete/ terracotta effect

EFFETTO CEMENTO/COTTO
IMITATION CIMENTS/COTTO
COTTO UND
BETON-OPTIK
ЦЕМЕНТ И КОТТО

108	borgate fiorentine
110	brera
114	concreta
118	cottoantico
122	cottocemento
130	ferrocemento
142	global
152	icon
162	icon roc
164	logica
168	neutra
176	salento
178	urbandeck
182	valencia

marble effect

EFFETTO MARMO
IMITATION MARBRE
MARMOR-OPTIK / МРАМОР

188	cave
206	cave roc
208	cremo
210	shine

wood effect

EFFETTO LEGNO
IMITATION BOI
HOLZ-OPTIK / ДЕРЕВО

222	alpi
228	painted
230	tundra

color effect

EFFETTO COLORE
GAMME COULEUR
UNIFARBEN
ЦВЕТОВОЙ ЭФФЕКТ

236	i colori
-----	----------

2CM outdoor paving 20 mm

246	alpi grip
248	artica roc
250	frammenta roc
252	icon grip
254	neutra roc
256	titano grip
258	urbandeck grip

160x320x12 mm

262	pietrasanta forte grafite ceppo grigio lasa timber crystal white basaltina ferrocemento grigio onix ice
-----	--

Outdoor paving index

INDICE GRIP - INDEX GRIP
VERZEICHNIS AUSSENBEREICH
УКАЗАТЕЛЬ «GRIP»

222	alpi grip
246	alpi grip 2CM - 20mm
30	artica roc
248	artica roc 2CM - 20mm
206	cave roc
38	cosmos naturale/grip
118	cottoantico grip
122	cottocemento grip
48	district roc
130	ferrocemento grip
58	frammenta roc
250	frammenta roc 2CM - 20mm
60	galapagos grip
162	icon roc
252	icon grip 2CM - 20mm
74	kaleido roc
82	luserna roc
86	morestone grip
168	neutra grip
254	neutra roc 2CM - 20mm
228	painted grip
90	phoenix grip
94	titano grip
256	titano grip 2CM - 20mm
230	tundra grip
258	urbandeck grip 2CM - 20mm
182	valencia corindonato



—

|

|

—

—

|

|

—

Index

INDICE - INDEX - VERZEICHNIS - УКАЗАТЕЛЬ

-
- 4 **Saime - fine Italian porcelain stoneware since 1938**
-
- 17 **Index A-Z** - Indice A-Z - Index A-Z
Verzeichnis In Alphabetischer Reihenfolge
Алфавитный Указатель
-
- 18 **Look index** - Indice per aspetto
Index par aspect - Verzeichnis nach Optik
Указатель design
-
- 19 **Outdoor paving index** - Indice GRIP
Index GRIP - Verzeichnis Aussenbereich
Указатель «GRIP»
-
- 20 **Index by format** - Indice per formato
Index selon le format - Verzeichnis nach
format - Индекс по формату
-
- 23 **Stone Effect** - Effetto Pietra - Imitation
Pierre - Steineffekt - Камень
-
- 107 **Concrete/terracotta effect** - Effetto
cemento - Cotto imitation ciments/cotto
Cotto und Beton-Optik - Цемент и котто
-
- 187 **Marble effect** - Effetto marmo
Imitation marbre - Marmor-Optik
Мрамор
-
- 221 **Wood effect** - Effetto legno
Imitation boi - Holz-Optik - Дерево
-
- 235 **Color effect** - Effetto colore
Gamme couleur - Unifarben
Цветовой эффект
-
- 245 **2CM Outdoor paving 20 mm**
-
- 261 **160x320x12 mm**
-
- 268 **Technical section** - Sezione tecnica
Section technique - Technischer abshnitt
Ктехнический раздел
-





fine Italian porcelain stoneware since 1938

La storia di Saime Ceramiche affonda le proprie radici nel 1938 e da allora ha rafforzato costantemente un obiettivo: produrre gres porcellanato di alta qualità. Ispirati dalla natura o guidati dalla pura creatività, Saime Ceramiche realizza superfici che sanno coniugare performance e bellezza.

The Saime Ceramiche story started in 1938, and since then the company has remained true to its initial objective: to make high quality porcelain stoneware. Inspired by nature or guided by unfettered creativity, Saime Ceramiche makes surfaces which perfectly combine beauty with technical performance.

La société Saime Ceramiche a été fondée en 1938 et n'a depuis jamais cessé de renforcer son objectif: produire du grès cérame de haute qualité. Inspirée par la nature ou guidée par la pure créativité, Saime Ceramiche réalise des surfaces à même de conjuguer performance et beauté.

Die Geschichte von Saime Ceramiche beginnt im Jahr 1938 und seitdem wurde ein Ziel konstant vorangebracht: die Herstellung von hochwertigem Steinzeug. Saime Ceramiche schafft - von der Natur inspiriert oder von reiner Kreativität geleitet - Oberflächen, die Leistung und Schönheit miteinander verbinden.





“  ”
Ceramics of Italy

TILE+ premium slabs

Attraverso l'incessante ricerca materica e l'innovazione industriale è nato un sodalizio unico che si traduce in lastre dalle proporzioni e bellezza incredibili.

Il progetto TILE+ riflette un'esperienza pluridecennale fatta di investimenti tecnologici e un impegno costante rivolto alla ricerca del prodotto.

Unceasing research into materials and processes have enabled us to produce tiles of incredible size and beauty.

The TILE+ project is the outcome of decades of technological investment and unremitting product R&D.

Une recherche constante liée à la matière et l'innovation industrielle ont donné naissance à une association unique, qui s'est traduite par la création de dalles aux proportions et à la beauté incroyables. **Le projet TILE+ est le reflet d'une longue expérience caractérisée par l'investissement technologique et un engagement constant destiné à la recherche du produit.**

Durch permanente Materialforschung und industrielle Innovation ist eine einzigartige Bindung entstanden, die sich in Platten von unglaublicher Größe und Schönheit widerspiegelt. **Das Projekt TILE+ spiegelt die jahrzehntelange Erfahrung mit technologischen Investitionen und ein ständiges Engagement in der Produktforschung wider.**



e,
s



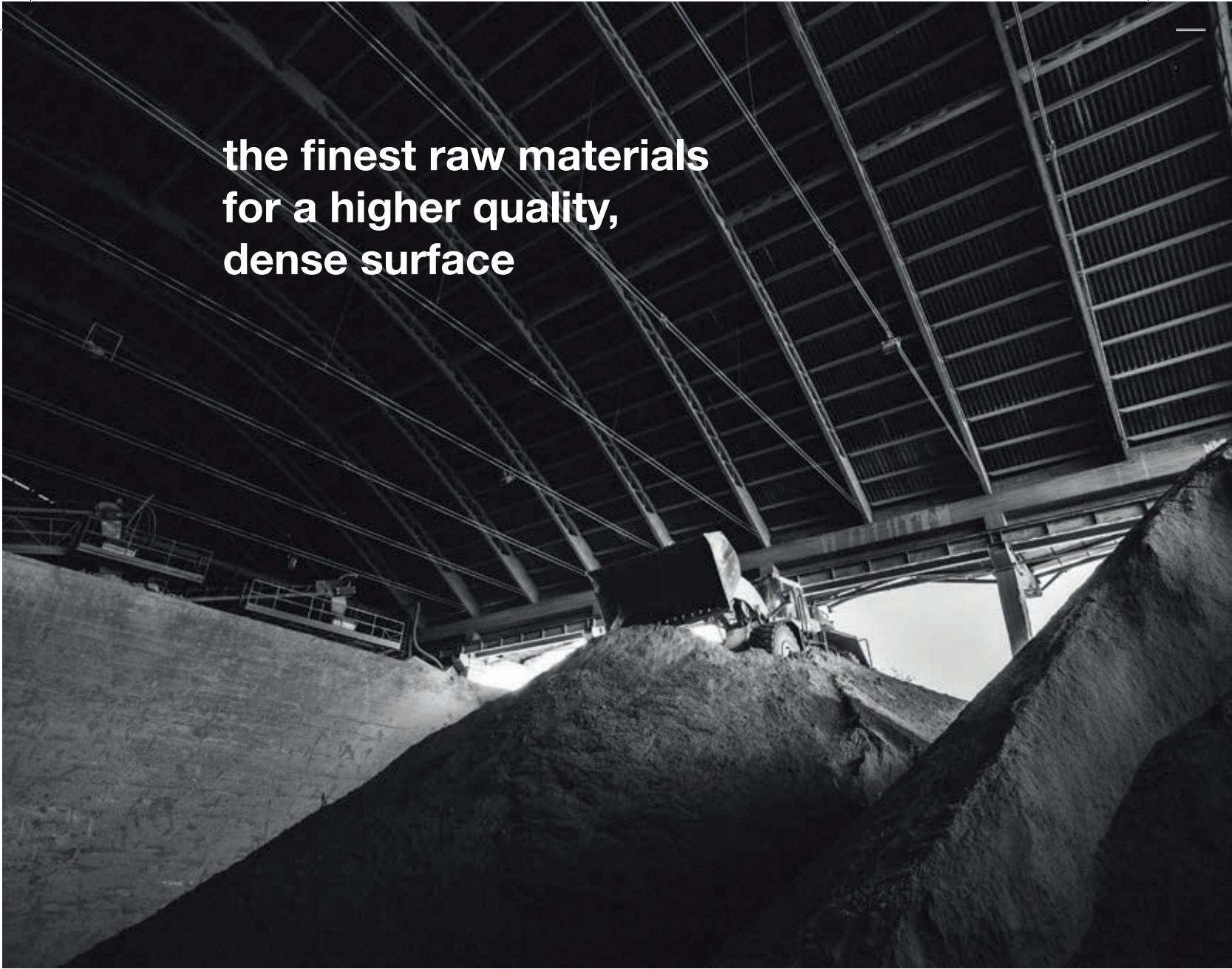

**the finest raw materials
for a higher quality,
dense surface**

La qualità inizia con la **selezione delle migliori materie prime**, una composizione di sabbie, argille e altri materiali naturali che vengono sottoposti a un processo di pressatura e cottura ad una temperatura che supera i 1200°. La sinterizzazione trasforma la materia in un **corpo solido dalle caratteristiche insuperabili**, una lastra di gres porcellanato resistente, versatile e autentica.

Quality starts with the **selection of the best raw materials**, a mix of sand, clay and other natural materials which are pressed and fired at temperatures in excess of 1200°C. Sintering transforms the material into a **solid body with unbeatable characteristics**, a strong, versatile and authentic porcelain stoneware slab.

La qualité commence par la **sélection des meilleures matières premières**, une composition de sables, d'argiles et d'autres matériaux naturels qui sont soumis à un processus de pressage et de cuisson à une température supérieure à 1200°. La sinterisation transforme la matière en un **corps solide aux caractéristiques incomparables**, une dalle de grès cérame résistante, polyvalente et authentique.

Die Qualität beginnt bei der **Auswahl der besten Rohstoffe**, einer Zusammenstellung aus Sand, Ton und anderen natürlichen Materialien, die bei einer Temperatur von über 1200 °C einem Press- und Brennverfahren unterzogen werden. Das Sintern verwandelt das Material in einen **festen Körper mit unübertrefflichen Eigenschaften**, eine widerstandsfähige, vielseitige und authentische Steinzeugplatte.

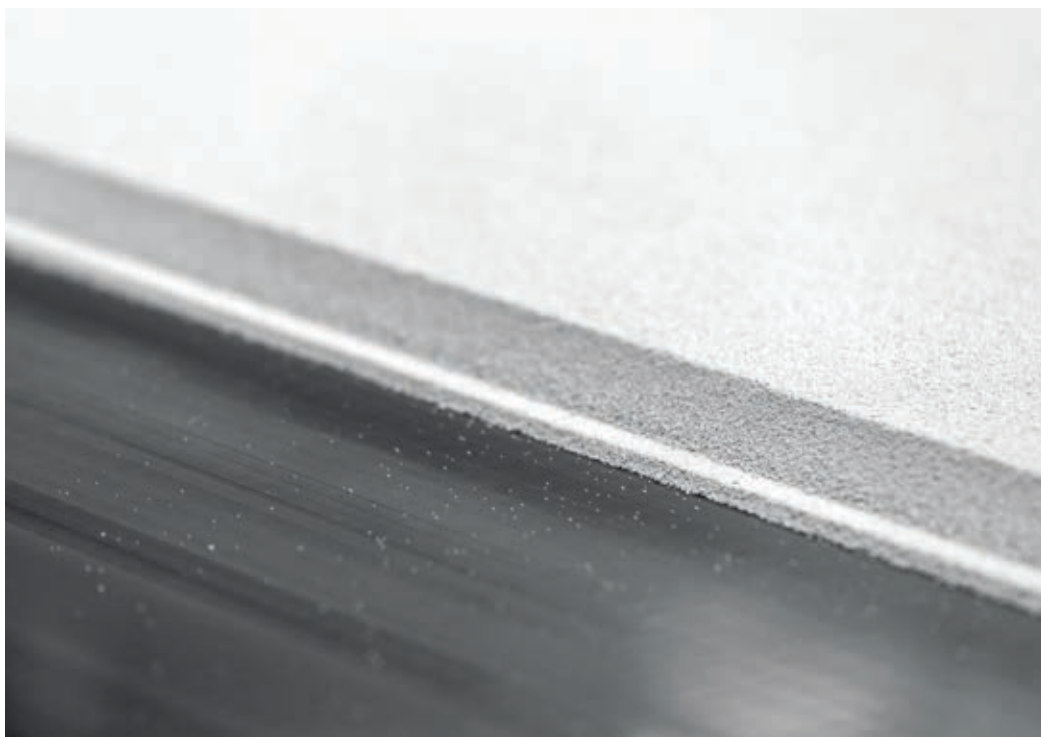

es
e,
s,

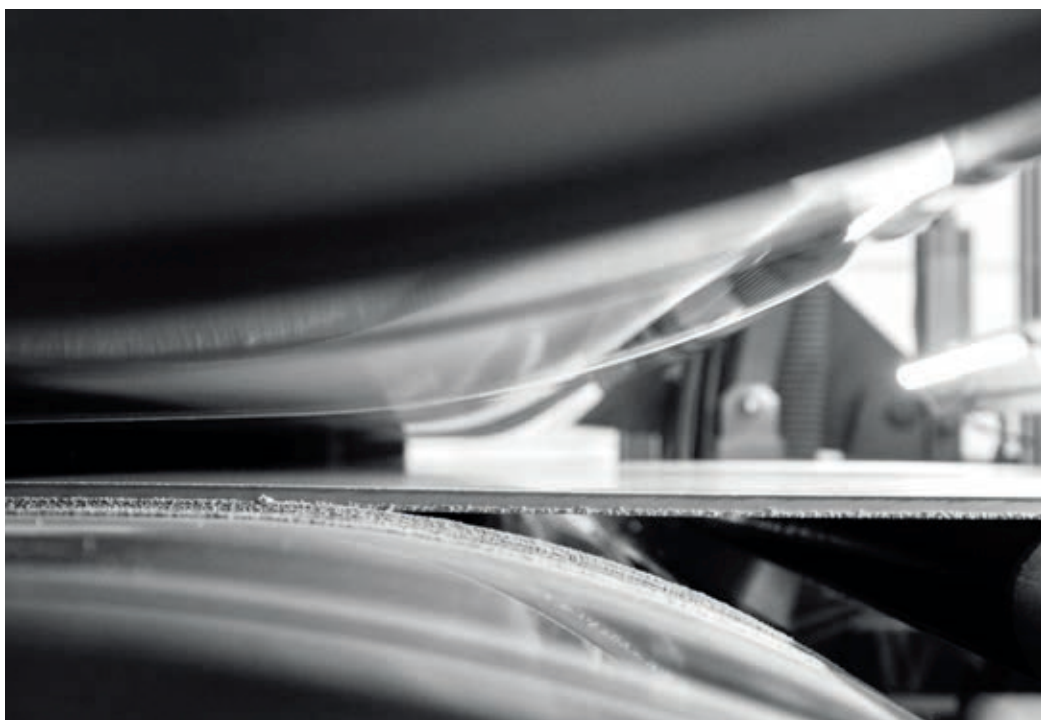

100% made in Italy

Dal processo produttivo alla sicurezza sul posto di lavoro, Saime Ceramiche garantisce elevati standard qualitativi e totale affidabilità. **Innovazione e responsabilità sociale ci guidano costantemente per sostenere il rispetto dell'ambiente, dei lavoratori e del consumatore finale.**

From processes to occupational health and safety, Saime Ceramiche guarantees the highest quality and total reliability. **Innovation and social responsibility guide us in our respect for the environment, our employees and the customer.**

Du processus de production à la sécurité sur le lieu de travail, Saime Ceramiche garantit des critères de qualité élevés et une fiabilité totale. **L'innovation et la responsabilité sociale nous guident constamment pour soutenir le respect de l'environnement, des travailleurs et du consommateur final.**

Saime Ceramiche garantiert vom Produktionsprozess bis hin zur Sicherheit am Arbeitsplatz hohe Qualitätsstandards und absolute Zuverlässigkeit. **Innovation und soziale Verantwortung leiten uns ständig dazu an, den Respekt vor der Umwelt, den Arbeitnehmern und dem Endverbraucher zu fördern.**



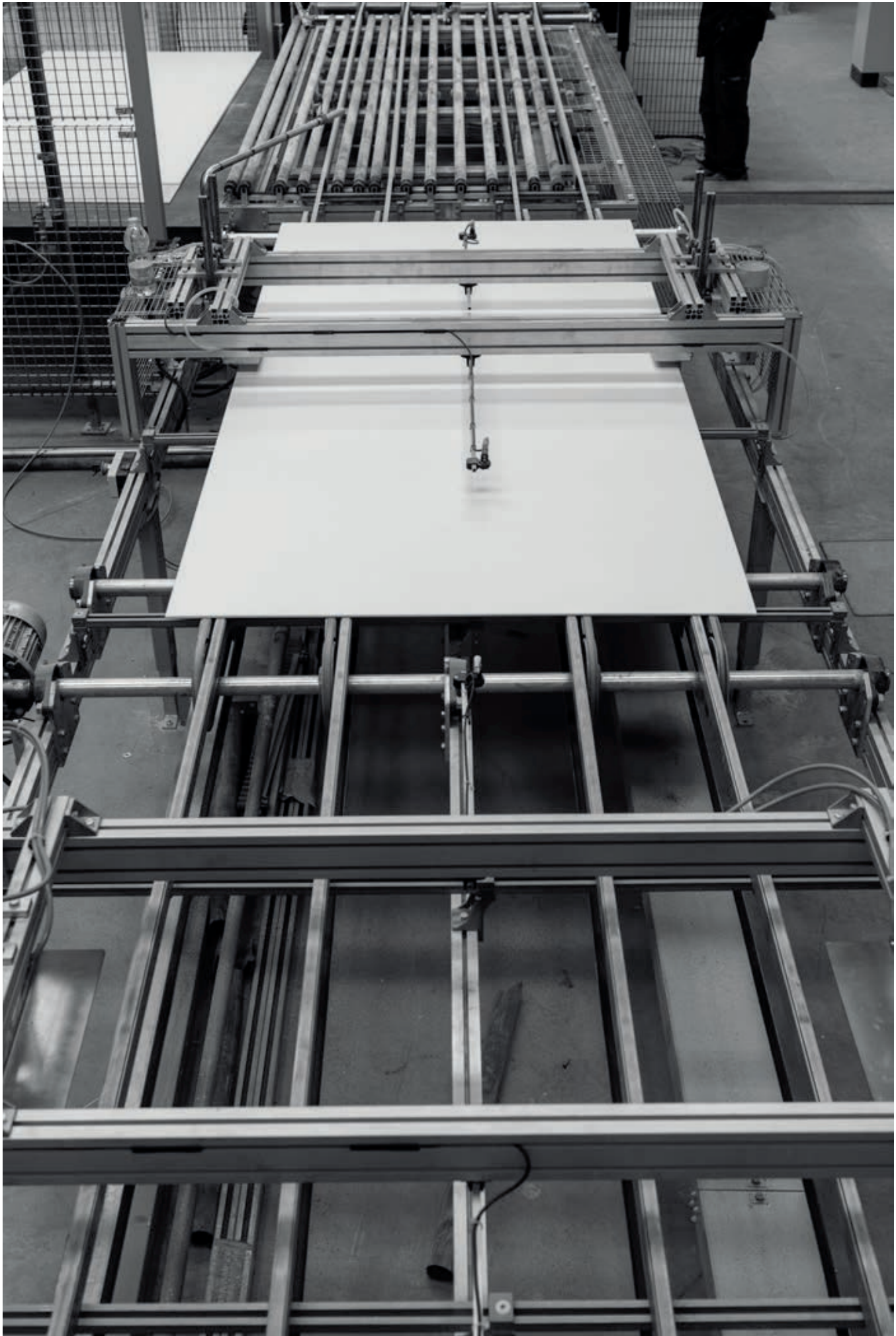

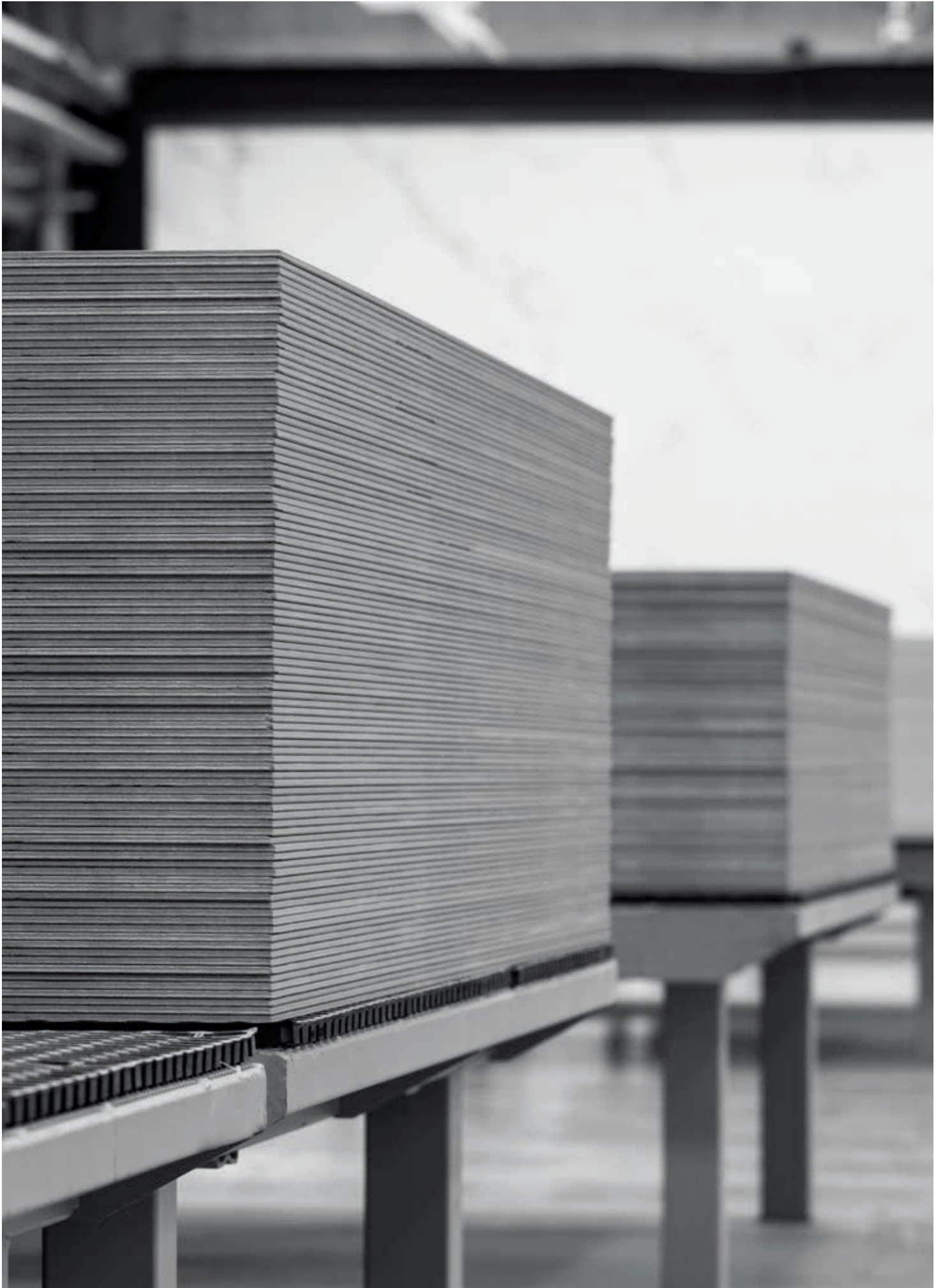

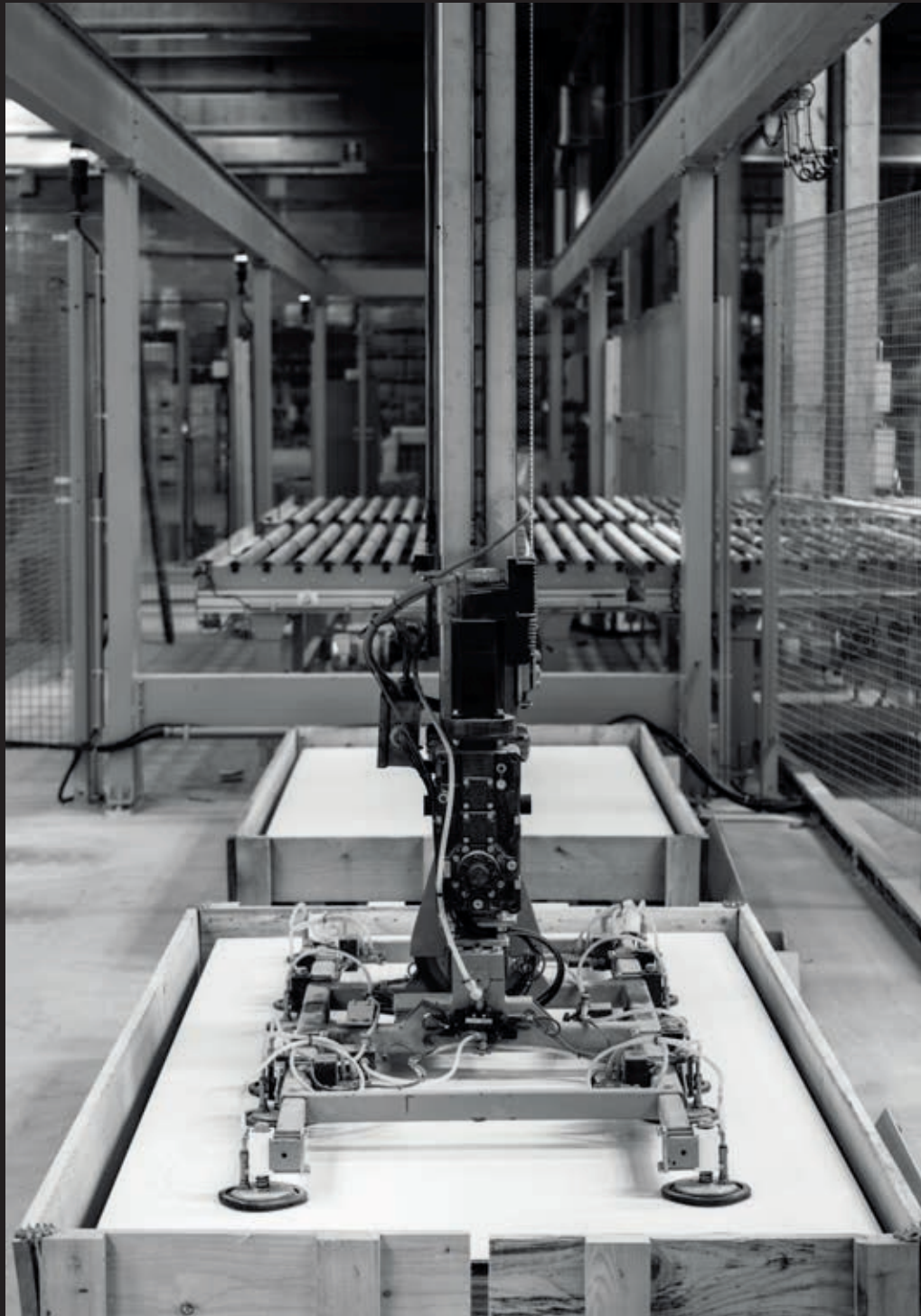

quality control from materials to packaging

Saime Ceramiche non trascura nessun passaggio, **garantisce sicurezza e controllo anche nel sistema di imballaggio, in cavalletto o casse.**

Saime Ceramiche takes no step in the process for granted, **guaranteeing safety and controls even in the final phase of packaging on racks or in crates.**

La marque Saime Ceramiche ne néglige aucune étape, **elle garantit sécurité et contrôle y compris dans le système d'emballage, sur chevalet ou en caisses.**

Bei Saime Ceramiche wird auch der kleinste Schritt nicht vernachlässigt. **Sicherheit und Kontrolle stehen auch im Verpackungssystem, auf Böcken oder in den Kisten, an oberster Stelle.**



n,

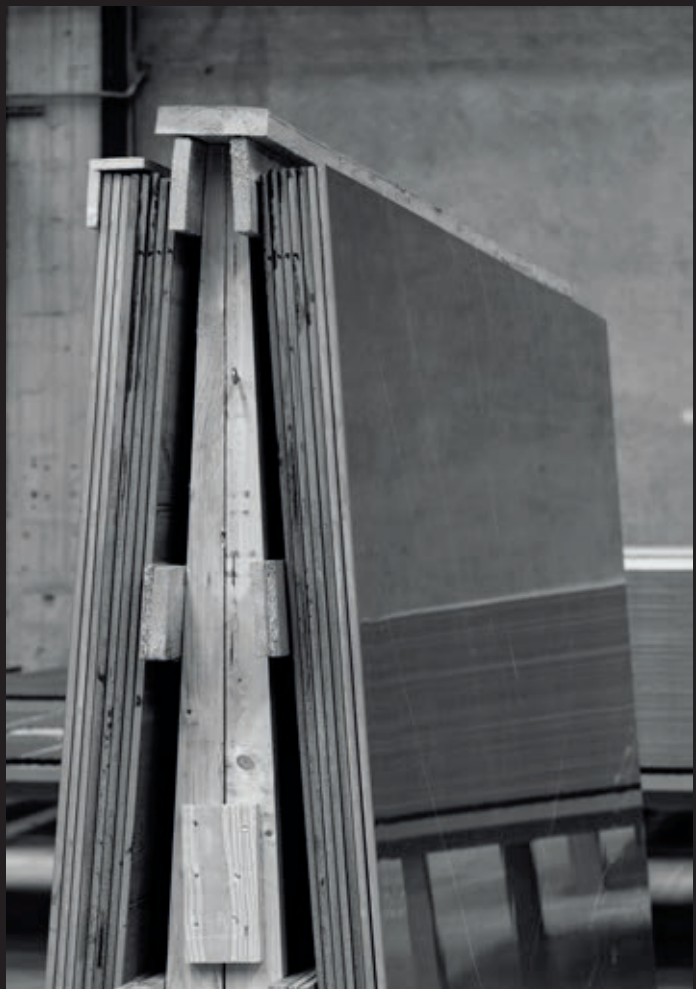



Index A-Z

INDICE A-Z - INDEX A-Z - VERZEICHNIS IN ALPHABETISCHER REIHENFOLGE - АЛФАВИТНЫЙ УКАЗАТЕЛЬ

222	alpi
246	alpi grip 2CM
24	artica
30	artica roc
248	artica roc 2CM
108	borgate fiorentine
34	boulevard
110	brera
188	cave
206	cave roc
114	concreta
38	cosmos
118	cottoantico
122	cottocemento
208	cremo
44	district
48	district roc
50	eternity
130	ferrocemento
54	frammenta
58	frammenta roc
250	frammenta roc 2CM
60	galapagos
142	global

236	i colori
152	icon
162	icon roc
252	icon grip 2CM
62	kaleido
74	kaleido roc
164	logica
78	luserna
82	luserna roc
86	morestone
168	neutra
254	neutra roc 2CM
228	painted
90	phoenix
176	salento
210	shine
94	titano
256	titano grip 2CM
230	tundra
178	urbandeck
258	urbandeck grip 2CM
182	valencia
102	volcano
262	160x320 12mm

Look index

INDICE PER ASPETTO - INDEX PAR ASPECT - VERZEICHNIS NACH OPTIK - УКАЗАТЕЛЬ DESIGN

stone effect

EFFETTO PIETRA
IMITATION PIERRE
STEINEFFEKT
КАМЕНЬ

24	artica
30	artica roc
34	boulevard
38	cosmos
44	district
48	district roc
50	eternity
54	frammenta
58	frammenta roc
60	galapagos
62	kaleido
74	kaleido roc
78	luserna
82	luserna roc
86	morestone
90	phoenix
94	titano
102	volcano

concrete/ terracotta effect

EFFETTO CEMENTO/COTTO
IMITATION CIMENTS/COTTO
COTTO UND BETON-OPTIK
ЦЕМЕНТ И КОТТО

108	borgate fiorentine
110	brera
114	concreta
118	cottoantico
122	cottocemento
130	ferrocemento
142	global
152	icon
162	icon roc
164	logica
168	neutra
176	salento
178	urbandeck
182	valencia

marble effect

EFFETTO MARMO
IMITATION MARBRE
MARMOR-OPTIK
МРАМОР

188	cave
206	cave roc
208	cremo
210	shine

wood effect

EFFETTO LEGNO
IMITATION BOI
HOLZ-OPTIK
ДЕРЕВО

222	alpi
228	painted
230	tundra

color effect

EFFETTO COLORE
GAMME COULEUR
UNIFARBEN
ЦВЕТОВОЙ ЭФФЕКТ

236	i colori
-----	----------

2CM outdoor paving 20 mm

246	alpi grip
248	artica roc
250	frammenta roc
252	icon grip
254	neutra roc
256	titano grip
258	urbandeck grip

160x320x12 mm

262	pietrasanta forte grafite ceppo grigio lasa timber crystal white basaltina ferrocemento grigio onix ice
-----	--











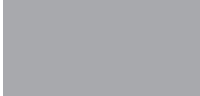

Outdoor paving index

INDICE GRIP - INDEX GRIP - VERZEICHNIS AUSSENBEREICH - УКАЗАТЕЛЬ «GRIP»

222	alpi grip
246	alpi grip 2CM - 20mm
30	artica roc
248	artica roc 2CM - 20mm
206	cave roc
38	cosmos naturale/grip
118	cottoantico grip
122	cottocemento grip
48	district roc
130	ferrocemento grip
58	frammenta roc
250	frammenta roc 2CM - 20mm
60	galapagos grip
162	icon roc
252	icon grip 2CM - 20mm
74	kaleido roc
82	luserna roc
86	morestone grip
168	neutra grip
254	neutra roc 2CM - 20mm
228	painted grip
90	phoenix grip
94	titano grip
256	titano grip 2CM - 20mm
230	tundra grip
258	urbandeck grip 2CM - 20mm
182	valencia corindonato

Index by format

INDICE PER FORMATO - INDEX SELON LE FORMAT - VERZEICHNIS NACH FORMAT - ИНДЕКС ПО ФОРМАТУ

≠ 6,5 mm	≠ 6 mm	TILE+	≠ 12 mm	TILE+
 120x260 47"x102" 188 cave 130 ferrocemento 142 global	 90x270 36"x106" 188 cave 130 ferrocemento 236 i colori 152 icon 210 shine		 160x320 63"x126" 262 pietrasanta forte grafite lasa crystal white onix ice ferrocemento grigio ceppo grigio timber basaltina	
 120x240 47"x95" 130 ferrocemento	 90x90 36"x36" 188 cave 130 ferrocemento 236 i colori 152 icon 210 shine			
 120x120 47"x47" 188 cave 130 ferrocemento 142 global	 45x90 18"x36" 188 cave 130 ferrocemento 236 i colori 152 icon 210 shine		<div style="background-color: #008000; color: white; padding: 2px; display: inline-block;">≠ 20 mm</div> 	
 60x120 24"x47" 188 cave 130 ferrocemento 142 global	 30x90 12"x36" 188 cave 130 ferrocemento 236 i colori 152 icon 210 shine		 60x120 24"x47" 252 icon grip 256 titano grip	
			 40x120 16"x47" 246 alpi grip 258 urbandeck grip	
			 60x60 24"x24" 248 artica roc 250 frammenta roc 252 icon grip 254 neutra roc 256 titano grip	

≠ 9 mm

standard

	110 brera		
60x120 24"x47"	188 cave	75,5x75,5 30"x30"	45x45 18"x18"
34 boulevard	206 cave roc	122 cottocemento ≠10	24 artica ≠10
188 cave	114 concreta		114 concreta
44 district	38 cosmos	30x120 12"x47"	122 cottocemento
130 ferrocemento	118 cottoantico	222 alpi	50 eternity
54 frammenta	122 cottocemento	188 cave	62 kaleido
142 global	208 cremo	130 ferrocemento	164 logica
152 icon	44 district		168 neutra
62 kaleido	48 district roc	20x120 8"x47"	182 valencia
86 morestone	50 eternity	222 alpi	
168 neutra	130 ferrocemento	230 tundra	33,3x33,3 13"x13"
210 shine	54 frammenta		108 borgate fiorentine ≠8
94 titano	58 frammenta roc ≠8	45x90 18"x36"	164 logica ≠7,5
178 urbandeck	142 global	24 artica ≠10	182 valencia ≠8
	152 icon	38 cosmos ≠10	
60x60 24"x24"	162 icon roc	62 kaleido ≠10	30x30 12"x12"
24 artica	62 kaleido		30 artica roc ≠8
30 artica roc	74 kaleido roc	22,5x90 9"x36"	44 district
34 boulevard	164 logica	24 artica ≠10	50 eternity ≠8
110 brera	78 luserna		60 galapagos grip ≠8
188 cave	82 luserna roc	15x90 6"x36"	62 kaleido ≠8
206 cave roc	86 morestone	222 alpi ≠8	74 kaleido roc ≠8
114 concreta	168 neutra	228 painted ≠8	78 luserna ≠8
122 cottocemento	90 phoenix		82 luserna roc ≠8
44 district	210 shine	20x40 8"x16"	168 neutra ≠8
48 district roc	94 titano	38 cosmos ≠8,3	
130 ferrocemento	178 urbandeck	118 cottoantico ≠8,3	20x20 8"x8"
54 frammenta	102 vulcano		38 cosmos ≠8,3
142 global		15x30 6"x12"	118 cottoantico ≠8,3
152 icon	90x180 36"x71"	38 cosmos	
62 kaleido	188 cave ≠10	60 galapagos ≠8	15x15 6"x6"
86 morestone	130 ferrocemento ≠10	78 luserna ≠8	24 artica
168 neutra		82 luserna roc ≠8	44 district ≠8
176 salento	75,5x151,2 30"x60"		62 kaleido ≠8
210 shine	122 cottocemento ≠10	10x30 4"x12"	82 luserna roc ≠8
94 titano		94 titano	90 phoenix
178 urbandeck	90x90 36"x36"		
	110 brera ≠10		
30x60 12"x24"	188 cave ≠10		
24 artica			
30 artica roc			
34 boulevard			

collections 2021

01

stone effect

effetto pietra / imitation pierre

Steineffekt / Камень

artica	24
artica roc	30
boulevard	34
cosmos	38
district	44
district roc	48
eternity	50
frammenta	54
frammenta roc	58
galapagos	60
kaleido	62
kaleido roc	74
luserna	78
luserna roc	82
morestone	86
phoenix	90
titano	94
volcano	102



artica | stone effect

COLORI

colours - couleurs - farbe - ЦВЕТА

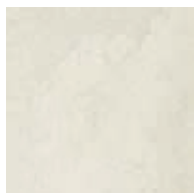

bianco

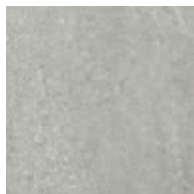

nube



grigio

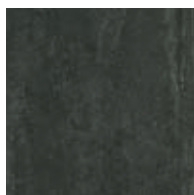

antracite

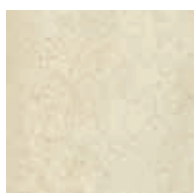

beige



brandy

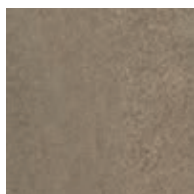

tabacco

FORMATI

sizes - formats - format - ФОРМАТЫ

formati modulari



≠9

60x60 (24"x24") RETT.



≠9

30x60 (12"x24") RETT.



≠9

30x60 (12"x24") NON RETT.

formati modulari

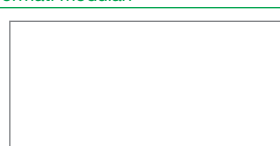

≠10

45x90 (18"x36") RETT.



≠10

22,5x90 (9"x36") RETT.



≠10

45x45 (18"x18") RETT.



≠9

14,8x14,8 (6"x6") RETT.

> pag. 30

ROC

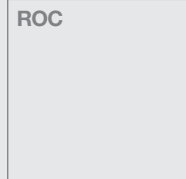

≠9

60x60 (24"x24") RETT.

> pag. 248

ROC 2CM

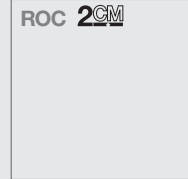

≠20

60x60 (24"x24") RETT.

ROC

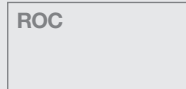

≠9

30x60 (12"x24") RETT./NON RETT.

ROC

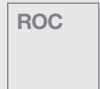

≠8

30x30 (12"x12") NON RETT.

2 FINITURE

finishes - surfaces

Oberfläche - ПОВЕРХНОСТИ

Naturale

Lappato

GM

V3



POSA 1/4



FUGA 2 mm
PER RETT.



FUGA >3 mm
PER NON RETT.

artica | stone effect

bianco

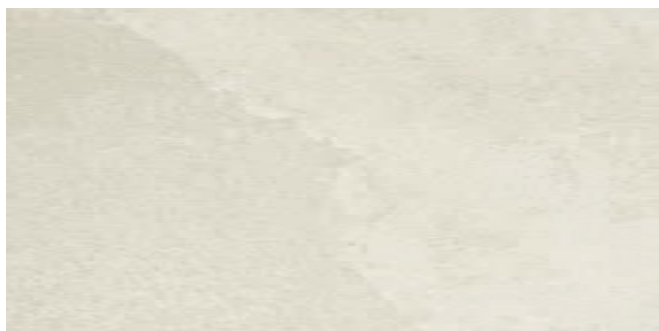

beige

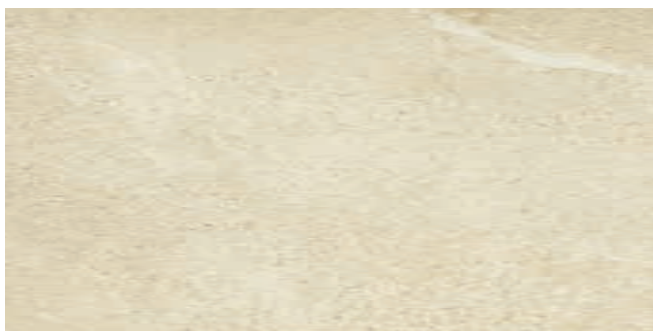

nube

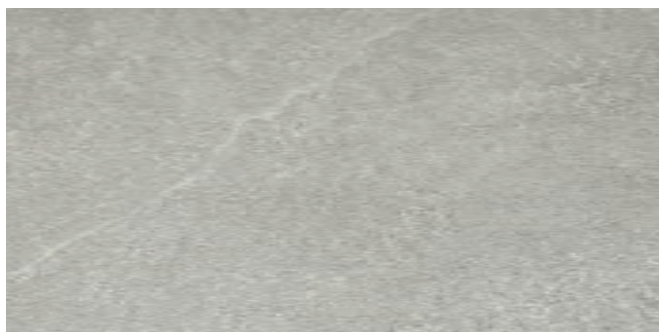

brandy

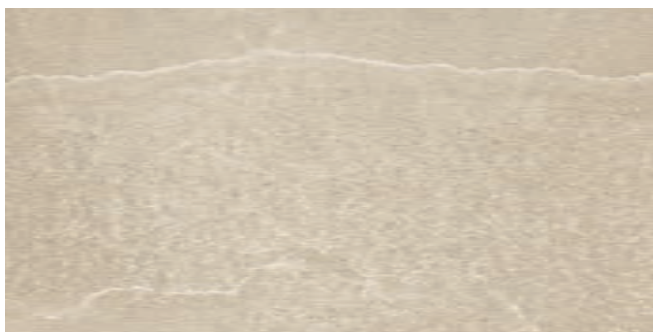

grigio



tabacco



antracite

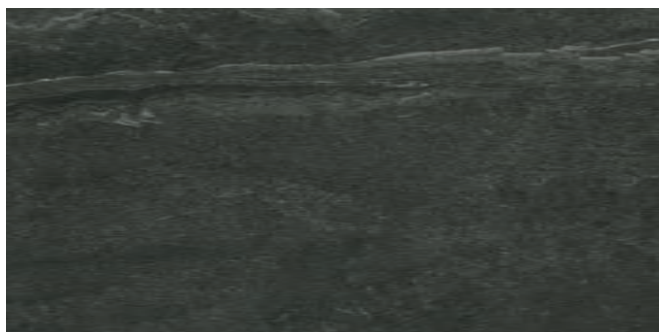

artica | stone effect



60x60 (24"x24")
rett. 78 ●
8600610 bianco nat. rett.
8600650 nube nat. rett.
8600640 grigio nat. rett.
8600600 antracite nat. rett.
8600620 beige nat. rett.
8600630 brandy nat. rett.
8600660 tabacco nat. rett.

lappato rett. 88 ●
8600340 bianco lapp. rett.
8600370 nube lapp. rett.
8600360 grigio lapp. rett.
8600320 antracite lapp. rett.
8600330 beige lapp. rett.
8600350 brandy lapp. rett.
8600380 tabacco lapp. rett.



30x60 (12"x24")
rett. 78 ●
8600611 bianco nat. rett.
8600651 nube nat. rett.
8600641 grigio nat. rett.
8600601 antracite nat. rett.
8600621 beige nat. rett.
8600631 brandy nat. rett.
8600661 tabacco nat. rett.

lappato rett. 88 ●
8600341 bianco lapp. rett.
8600371 nube lapp. rett.
8600361 grigio lapp. rett.
8600321 antracite lapp. rett.
8600331 beige lapp. rett.
8600351 brandy lapp. rett.
8600381 tabacco lapp. rett.



30x60 (12"x24")
non rett. 68 ●
7677815 bianco nat.
7677875 nube nat.
7677835 grigio nat.
7677845 antracite nat.
7677825 beige nat.
7677865 brandy nat.
7677855 tabacco nat.



14,8x14,8 (6"x6")
rett. 96 ●
7661298 bianco nat. rett.
7661278 nube nat. rett.
7661288 grigio nat. rett.
7661268 antracite nat. rett.
7661276 brandy nat. rett.



45x90 (18"x36")
rett. 84 ●
7663815 bianco nat. rett.
7664635 nube nat. rett.
7663835 grigio nat. rett.
7663845 antracite nat. rett.
7663825 beige nat. rett.
7664625 brandy nat. rett.
7664615 tabacco nat. rett.

lappato rett. 92 ●
7663855 bianco lapp. rett.
7664665 nube lapp. rett.
7663875 grigio lapp. rett.
7663885 antracite lapp. rett.
7663865 beige lapp. rett.
7664655 brandy lapp. rett.
7664645 tabacco lapp. rett.



22,5x90 (9"x36")
rett. 84 ●
7665415 bianco nat. rett.
7665475 nube nat. rett.
7665435 grigio nat. rett.
7665445 antracite nat. rett.
7665425 beige nat. rett.
7665465 brandy nat. rett.
7665455 tabacco nat. rett.

lappato rett. 92 ●
7665485 bianco lapp. rett.
7665545 nube lapp. rett.
7665505 grigio lapp. rett.
7665515 antracite lapp. rett.
7665495 beige lapp. rett.
7665535 brandy lapp. rett.
7665525 tabacco lapp. rett.



45x45 (18"x18")
rett. 84 ●
7663895 bianco nat. rett.
7665195 nube nat. rett.
7663915 grigio nat. rett.
7663925 antracite nat. rett.
7663905 beige nat. rett.
7665185 brandy nat. rett.
7665175 tabacco nat. rett.

lappato rett. 92 ●
7663935 bianco lapp. rett.
7665405 nube lapp. rett.
7663955 grigio lapp. rett.
7663965 antracite lapp. rett.
7663945 beige lapp. rett.
7665215 brandy lapp. rett.
7665205 tabacco lapp. rett.

mosaico
5x5 (2"x2") 124 ●



30x30 (12"x12")
7686495 bianco nat.
7686535 bianco lapp.



30x30 (12"x12")
7678065 nube nat.
7678095 nube lapp.



30x30 (12"x12")
7686515 grigio nat.
7686555 grigio lapp.



30x30 (12"x12")
7686525 antracite nat.
7686565 antracite lapp.

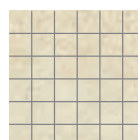

30x30 (12"x12")
7686505 beige nat.
7686545 beige lapp.

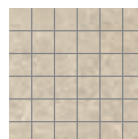

30x30 (12"x12")
7678055 brandy nat.
7678085 brandy lapp.



30x30 (12"x12")
7678045 tabacco nat.
7678075 tabacco lapp.

listellato 131 ●



30x60 (12"x24")
7678555 bianco nat.
7678625 bianco lapp.



30x60 (12"x24")
7678565 nube nat.
7678635 nube lapp.



30x60 (12"x24")
7678575 grigio nat.
7678645 grigio lapp.



30x60 (12"x24")
7678585 antracite nat.
7678655 antracite lapp.



30x60 (12"x24")
7678595 beige nat.
7678665 beige lapp.



30x60 (12"x24")
7678605 brandy nat.
7678675 brandy lapp.



30x60 (12"x24")
7678615 tabacco nat.
7678685 tabacco lapp.

PEZZI SPECIALI trims - pieces speciales - formstücke - СОБЫЕЭЛЕМЕНТЫ

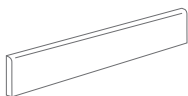

battiscopa rett.

7,5x60 (3"x24")

- 8600603 antracite nat. rett.
- 8600623 beige nat. rett.
- 8600613 bianco nat. rett.
- 8600633 brandy nat. rett.
- 8600643 grigio nat. rett.
- 8600653 nube nat. rett.
- 8600663 tabacco nat. rett.

24 ▲ 14 ◻

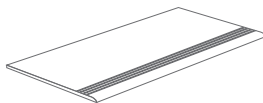

gradino step rett.

30x60 (12"x24")

- 8600602 antracite nat. rett.
- 8600622 beige nat. rett.
- 8600612 bianco nat. rett.
- 8600632 brandy nat. rett.
- 8600642 grigio nat. rett.
- 8600652 nube nat. rett.
- 8600662 tabacco nat. rett.

48 ▲ 7 ◻

IMBALLI packing - emballages - verpackung - УПАКОВКА

F.TO NOMINALE / NOMINAL SIZE	mm.	PCS / BOX	M2 / BOX	BOX / PLT	M2 / PLT	KG. / PLT
60x60 rett.	9	3	1,08	40	43,20	900
30x60 rett./non rett.	9	7	1,26	40	50,40	1120
45x90 rett.	10	3	1,215	30	36,45	840
22,5x90 rett.	10	6	1,215	36	43,74	972
45x45 rett.	10	6	1,22	26	31,72	655,20
14,8x14,8 rett.	9	32	0,72	56	40,32	800,8
30x30 mosaico	9	11	1	-	-	-
30x60 listellato	9	4	0,72	-	-	-

artica



artica | stone effect

artica roc | stone effect

artica roc

COLORI

colours - couleurs - farbe - ЦВЕТА

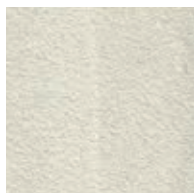

bianco

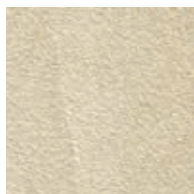

beige

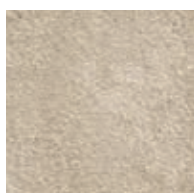

brandy



tabacco

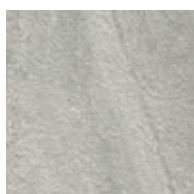

nube

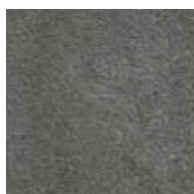

grigio

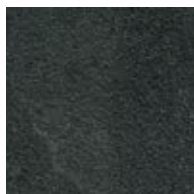

antracite

FORMATI

sizes - formats - format - ФОРМАТЫ

formati modulari

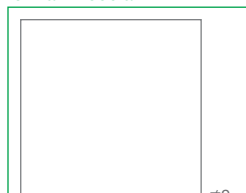

≠9

60x60 (24"x24") RETT.



≠9

30x60 (12"x24") RETT.



≠9

30x60 (12"x24") NON RETT.

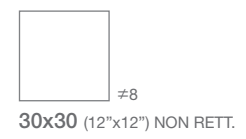

≠8

30x30 (12"x12") NON RETT.

GM

V3



POSA 1/4



FUGA 2 mm
PER RETT.



FUGA >3 mm
PER NON RETT.



DIN 51130
R11



DIN 51097
A+B+C

artica roc | stone effect

bianco roc



beige roc



nube roc



brandy roc



grigio roc



tabacco roc



antracite roc

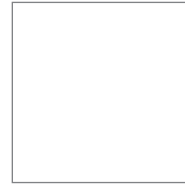

60x60 (24"x24")

rett.

78 ●

- 8600680 bianco roc rett.
- 8600720 nube roc rett.
- 8600710 grigio roc rett.
- 8600690 beige roc rett.
- 8600700 brandy roc rett.
- 8600670 antracite roc rett.
- 8600730 tabacco roc rett.



30x60 (12"x24")

rett.

78 ●

- 8600681 bianco roc rett.
- 8600721 nube roc rett.
- 8600711 grigio roc rett.
- 8600671 antracite roc rett.
- 8600691 beige roc rett.
- 8600701 brandy roc rett.
- 8600731 tabacco roc rett.



30x60 (12"x24")

non rett.

68 ●

- 7678925 bianco roc
- 7678915 nube roc
- 7678905 grigio roc
- 7678895 antracite roc
- 7678865 beige roc
- 7678875 brandy roc
- 7678885 tabacco roc



30x30 (12"x12")

non rett.

62 ●

- 7667081 bianco roc
- 7667111 nube roc
- 7667131 grigio roc
- 7667071 antracite roc
- 7667141 beige roc
- 7667121 brandy roc
- 7667151 tabacco roc

mosaico 5x5 (2"x2") 124 ●



30x30 (12"x12")
7679905 bianco roc



30x30 (12"x12")
7679925 nube roc

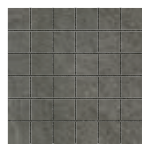

30x30 (12"x12")
7679915 grigio roc



30x30 (12"x12")
7679935 antracite roc



30x30 (12"x12")
7679895 beige roc



30x30 (12"x12")
7679955 brandy roc



30x30 (12"x12")
7679945 tabacco roc

PEZZI SPECIALI trims - pieces speciales - formstücke - СОБЫЕЭЛЕМЕНТЫ

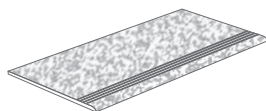

Gradino Step

- 30x60 (12"x24")
7678896 Antracite Roc
7678866 Beige Roc
7678926 Bianco Roc
7678876 Brandy Roc
7678906 Grigio Roc
7678916 Nube Roc
7678886 Tabacco Roc

48 ▲ 7 ◻

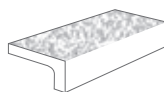

Elemento Elle Pressa

- 15x30x3,5 (6"x12"x 1,4")
7686566 Antracite Roc
7686546 Beige Roc
7686496 Bianco Roc
7686086 Brandy Roc
7686556 Grigio Roc
7678096 Nube Roc
7678076 Tabacco Roc

44 ▲ 8 ◻



* Gradone DP Rett.

- 33,3x60 (13"x24")
7690184 Antracite Roc Rett.
7690194 Beige Roc Rett.
7690204 Bianco Roc Rett.
7690217 Brandy Roc Rett.
7690224 Grigio Roc Rett.
7690234 Nube Roc Rett.
7690244 Tabacco Roc Rett.

113 ▲ 4 ◻

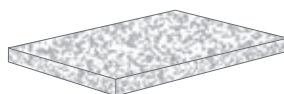

* Angolare DP SX Rett.

- 33,3x60 (13"x24")
7690187 Antracite Roc Rett.
7690197 Beige Roc Rett.
7690207 Bianco Roc Rett.
7690218 Brandy Roc Rett.
7690227 Grigio Roc Rett.
7690239 Nube Roc Rett.
7690247 Tabacco Roc Rett.

123 ▲ 2 ◻

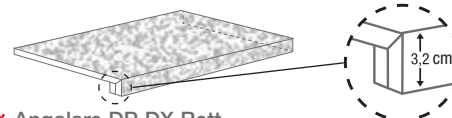

* Angolare DP DX Rett.

- 33,3x60 (13"x24")
7690188 Antracite Roc Rett.
7690198 Beige Roc Rett.
7690208 Bianco Roc Rett.
7690219 Brandy Roc Rett.
7690228 Grigio Roc Rett.
7690240 Nube Roc Rett.
7690248 Tabacco Roc Rett.

123 ▲ 2 ◻

artica roc | stone effect

IMBALLI packing - emballages - verpackung - УПАКОВКА

F.TO NOMINALE / NOMINAL SIZE	mm.	PCS / BOX	M2 / BOX	BOX / PLT	M2 / PLT	KG. / PLT
60x60 rett.	9	3	1,08	40	43,20	900
30x60 rett./non rett.	9	7	1,26	40	50,40	989
30x30 non rett.	8	13	1,17	48	56,16	960
30x30 mosaico	9	11	1	-	-	-



boulevard | stone effect

boulevard

COLORI

colours - couleurs - farbe - ЦВЕТА

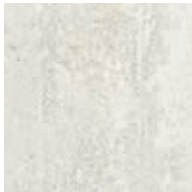

white

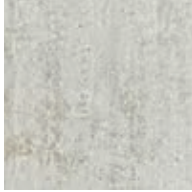

grey



sand



taupe

FORMATI

sizes - formats - format - ФОРМАТЫ

formati modulari



POSA 1/4



FUGA 2 mm

boulevard | stone effect

white



sand



grey



taupe



boulevard | stone effect

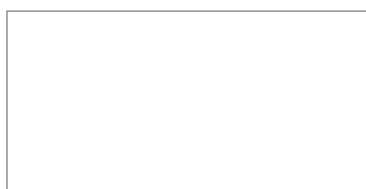

60x120 (24"x47") **86** ●
 8600771 white rett.
 8600741 grey rett.
 8600751 sand rett.
 8600761 taupe rett.



60x60 (24"x24") **78** ●
 8600770 white rett.
 8600740 grey rett.
 8600750 sand rett.
 8600760 taupe rett.



30x60 (12"x24") **78** ●
 8600772 white rett.
 8600742 grey rett.
 8600752 sand rett.
 8600762 taupe rett.

mosaico 5x5 (2"x2") **124** ●



30x30 (12"x12")
 7681125 white



30x30 (12"x12")
 7681135 grey



30x30 (12"x12")
 7681145 sand



30x30 (12"x12")
 7681155 taupe

listellato **131** ●

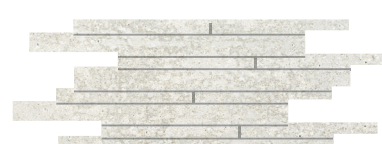

30x60 (12"x24")
 7681165 white



30x60 (12"x24")
 7681175 grey



30x60 (12"x24")
 7681185 sand



30x60 (12"x24")
 7681195 taupe

boulevard | stone effect

PEZZI SPECIALI

trims - pieces speciales - formstücke - СОБЫЕЭЛЕМЕНТЫ

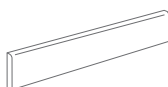

battiscopa rett.
7,5x60 (3"x24")
 8600764 taupe rett.
 8600754 sand rett.
 8600774 white rett.
 8600744 grey rett.

24 ▲ 14 ◻

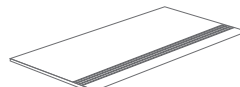

gradino step rett.
30x60 (12"x24")
 8600763 taupe rett.
 8600753 sand rett.
 8600773 white rett.
 8600743 grey rett.

48 ▲ 7 ◻

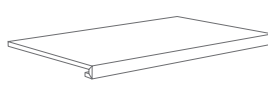

*** gradone CR rett.**
33,3x60 (13"x24")
 7648566 taupe rett.
 7648556 sand rett.
 7648536 white rett.
 7648546 grey rett.

113 ▲ 2 ◻

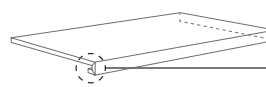

*** angolare CR SX rett.**
33,3x60 (13"x24")
 7648567 taupe rett.
 7648557 sand rett.
 7648537 white rett.
 7648547 grey rett.

123 ▲ 2 ◻

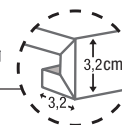

*** angolare CR DX rett.**
33,3x60 (13"x24")
 7648568 taupe rett.
 7648558 sand rett.
 7648538 white rett.
 7648548 grey rett.

123 ▲ 2 ◻

IMBALLI packing - emballages - verpackung - УПАКОВКА

F.TO NOMINALE / NOMINAL SIZE	mm.	PCS / BOX	M2 / BOX	BOX / PLT	M2 / PLT	KG. / PLT
60x120 rett.	9	2	1,44	36	51,84	1170
60x60 rett.	9	3	1,08	40	43,20	900
30x60 rett.	9	7	1,26	40	50,40	1120
30x30 mosaico	9	11	1	-	-	-
30x60 listellato	9	4	0,72	-	-	-

cosmos | stone effect

cosmos

COLORI

colours - couleurs - farbe - ЦВЕТА

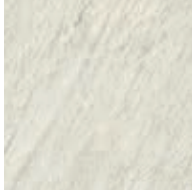

gesso



calcare



cemento



ossido

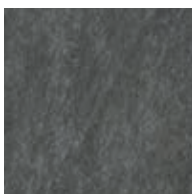

grafite

FORMATI

sizes - formats - format - ФОРМАТЫ

naturale



≠10

45x90 (18"x36") RETT.



≠9

30x60 (12"x24") NON RETT.

29,7x59,5 (12"x24") RETT.



≠8,3

20x40 (8"x16") NON RETT.



≠8,3

20x20 (8"x8") NON RETT.

grip



≠10

45x90 (18"x36") RETT.



≠9

30x60 (12"x24") NON RETT.

29,7x59,5 (12"x24") RETT.



≠8

15x30 (6"x12") NON RETT.

2 FINITURE

finishes - surfaces

Oberfläche - ПОВЕРХНОСТИ

Naturale

Grip

GM

V2



POSA 1/4



FUGA 2 mm
PER RETT.



FUGA >3 mm
PER NON RETT.



DIN 51130
R11
(GRIP)



DIN 51097
A+B+C
(GRIP)

cosmos | stone effect

gesso



calcare



cemento



cosmos | stone effect

ossido



grafite



naturale



45x90 (18"x36")
rett. 84 ●
 7600021 gesso rett.
 7960081 calcare rett.
 7600031 cemento rett.
 7600041 ossido rett.
 7600051 grafite rett.



30x60 (12"x24")
non rett. 68 ●
 7679271 gesso
 7679261 calcare
 7679291 cemento
 7679301 ossido
 7679281 grafite

29,7x59,5 (12"x24")
rett. 76 ●
 7679311 gesso rett.
 7679351 calcare rett.
 7679321 cemento rett.
 7679331 ossido rett.
 7679341 grafite rett.



20x40 (8"x16")
non rett. 68 ●
 7603601 gesso
 7603591 calcare
 7603611 cemento
 7603621 ossido
 7603631 grafite



20x20 (8"x8")
non rett. 68 ●
 7603291 gesso
 7603281 calcare
 7603301 cemento
 7603311 ossido
 7603321 grafite

grip

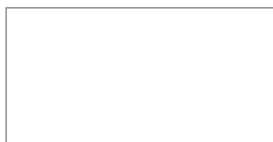

45x90 (18"x36")
grip rett. 84 ●
 7600791 gesso grip rett.
 7600781 calcare grip rett.
 7600801 cemento grip rett.
 7600761 ossido grip rett.
 7600771 grafite grip rett.



30x60 (12"x24")
grip non rett. 68 ●
 7679371 gesso grip
 7679361 calcare grip
 7679381 cemento grip
 7679391 ossido grip
 7679401 grafite grip

29,7x59,5 (12"x24")
grip rett. 76 ●
 7679421 gesso grip rett.
 7679411 calcare grip rett.
 7679431 cemento grip rett.
 7679441 ossido grip rett.
 7679451 grafite grip rett.



15x30 (6"x12")
grip non rett. 65 ●
 7700371 gesso grip
 7700411 calcare grip
 7700381 cemento grip
 7700391 ossido grip
 7700401 grafite grip

mosaico 5x5 (2"x2") 124 ●

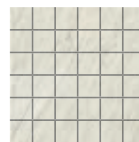

30x30 (12"x12")
 7679531 gesso nat.



30x30 (12"x12")
 7679571 calcare nat.

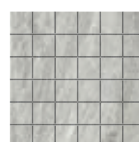

30x30 (12"x12")
 7679541 cemento nat.



30x30 (12"x12")
 7679551 ossido nat.



30x30 (12"x12")
 7679561 grafite nat.

cosmos | stone effect

PEZZI SPECIALI trims - pieces speciales - formstücke - СОБЫЕЭЛЕМЕНТЫ

naturale

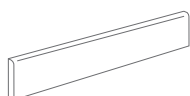

battiscopa rett.
7,5x60 (3"x24")
7676264 calcare rett.
7676294 cemento rett.
7676274 gesso rett.
7676284 grafite rett.
7676704 ossido rett.
24 ▲ 14 ◻

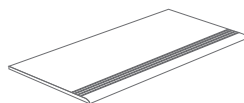

gradino step rett.
29,7x59,5 (12"x24")
7676265 calcare rett.
7676295 cemento rett.
7676275 gesso rett.
7676285 grafite rett.
7679705 ossido rett.
48 ▲ 7 ◻

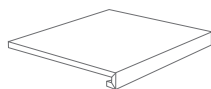

*** gradone CR rett.**
33,3x29,7 (13"x12")
7676266 calcare rett.
7676386 cemento rett.
7676276 gesso rett.
7676286 grafite rett.
7679706 ossido rett.
84 ▲ 4 ◻



*** angolare CR SX rett.**
33,3x29,7 (13"x12")
7676268 calcare rett.
7676387 cemento rett.
7676277 gesso rett.
7676287 grafite rett.
7679707 ossido rett.
110 ▲ 2 ◻

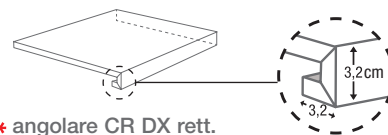

*** angolare CR DX rett.**
33,3x29,7 (13"x12")
7676267 calcare rett.
7676388 cemento rett.
7676278 gesso rett.
7676288 grafite rett.
7679708 ossido rett.
110 ▲ 2 ◻

grip

cosmos | stone effect

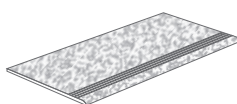

gradino step grip rett.
29,7x59,5 (12"x24")
7676364 calcare grip rett.
7676383 cemento grip rett.
7676375 gesso grip rett.
7676405 grafite grip rett.
7679793 ossido grip rett.
48 ▲ 7 ◻

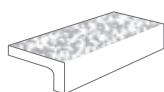

elemento elle pressa grip
15x30x3,5 (6"x12"x1,4")
7679365 calcare grip
7679367 cemento grip
7679366 gesso grip
7679368 grafite grip
7679369 ossido grip
44 ▲ 8 ◻

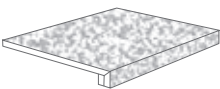

*** gradone DP grip rett.**
33,3x29,7 (13"x12")
7676269 calcare grip rett.
7676389 cemento grip rett.
7676279 gesso grip rett.
7679287 grafite grip rett.
7679709 ossido grip rett.
84 ▲ 4 ◻

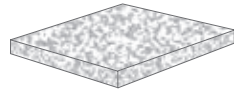

*** angolare DP SX grip rett.**
33,3x29,7 (13"x12")
7676270 calcare grip rett.
7679390 cemento grip rett.
7679280 gesso grip rett.
7679288 grafite grip rett.
7679710 ossido grip rett.
110 ▲ 2 ◻

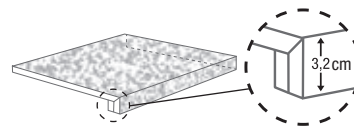

*** angolare DP DX grip rett.**
33,3x29,7 (13"x12")
7679270 calcare grip rett.
7676390 cemento grip rett.
7676280 gesso grip rett.
7679289 grafite grip rett.
7679711 ossido grip rett.
110 ▲ 2 ◻

IMBALLI packing - emballages - verpackung - УПАКОВКА

F.TO NOMINALE / NOMINAL SIZE	mm.	PCS / BOX	M2 / BOX	BOX / PLT	M2 / PLT	KG. / PLT
45x90 rett.	10	3	1,215	30	36,45	840
30x60 non rett.	9	7	1,26	40	50,40	989
29,7x59,5 rett.	9	7	1,24	40	49,60	1000
20x40 non rett.	8,3	18	1,44	56	80,64	1359
20x20 non rett.	8,3	30	1,20	68	81,60	1346,40
15x30 non rett.	8	23	1,04	75	78,00	1239
30x30 mosaico 5x5	9	11	1,00	-	-	-

cosmos

cosmos | stone effect

district | stone effect

COLORI

colours - couleurs - farbe - ЦВѢТА



bianco



beige



tortora



grigio



nero

FORMATI

sizes - formats - format - ФОРМАТЫ

formati modulari



60x120 (24"x47") RETT. ≠9



60x60 (24"x24") RETT. ≠9



30x60 (12"x24") RETT. ≠9



30x30 (12"x12") RETT. ≠9



15x15 (6"x6") NON RETT. ≠8

> pag. 48

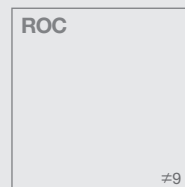

60x60 (24"x24") RETT. ≠9



30x60 (12"x24") RETT. ≠9



POSA 1/4



FUGA 2 mm
PER RETT.



FUGA >3 mm
PER NON RETT.

district | stone effect

bianco

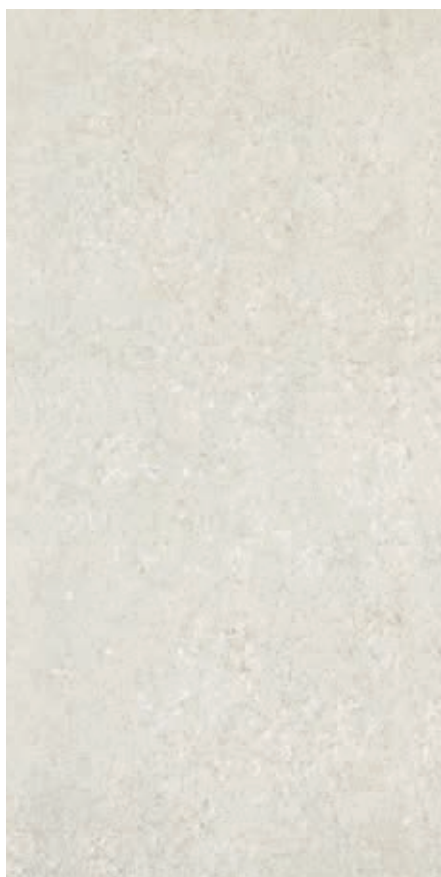

beige



tortora



district | stone effect

grigio



nero



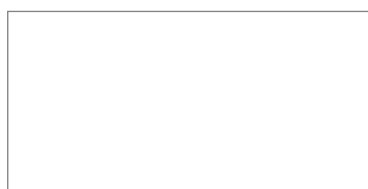

60x120 (24"x47")
rett.

- 8600891 bianco rett.
- 8600901 grigio rett.
- 8600911 nero rett.
- 8600881 beige rett.
- 8600921 tortora rett.

86 ●



60x60 (24"x24")
rett.

- 8600890 bianco rett.
- 8600900 grigio rett.
- 8600910 nero rett.
- 8600880 beige rett.
- 8600920 tortora rett.

78 ●



30x60 (12"x24")
rett.

- 8600892 bianco rett.
- 8600902 grigio rett.
- 8600912 nero rett.
- 8600882 beige rett.
- 8600922 tortora rett.

78 ●



30x30 (12"x12")
rett.

- 8600893 bianco rett.
- 8600903 grigio rett.
- 8600913 nero rett.
- 8600883 beige rett.
- 8600923 tortora rett.

86 ●



15x15 (6"x6")
non rett.

- 7697401 bianco
- 7697391 grigio
- 7697421 nero
- 7697411 beige
- 7697431 tortora

65 ●

mosaico 5x5 (2"x2") 124 ●



30x30 (12"x12")
7689245 bianco nat.



30x30 (12"x12")
7689235 beige nat.



30x30 (12"x12")
7690305 tortora nat.



30x30 (12"x12")
7689255 grigio nat.



30x30 (12"x12")
7689265 nero nat.

district | stone effect

PEZZI SPECIALI

trims - pieces speciales - formstücke - СОБИЕЭЛЕМЕНТЫ

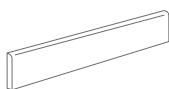

battiscopa rett.

- 7,5x60 (3"x24")
- 8600887 beige rett.
- 8600897 bianco rett.
- 8600907 grigio rett.
- 8600917 nero rett.
- 8600927 tortora rett.

24 ▲ 14 ◻

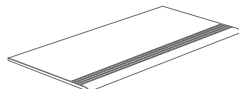

gradino step rett.

- 30x60 (12"x24")
- 8600884 beige rett.
- 8600894 bianco rett.
- 8600904 grigio rett.
- 8600914 nero rett.
- 8600924 tortora rett.

48 ▲ 7 ◻

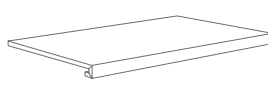

* gradone CR rett.

- 33,3x60 (13"x24")
- 7688898 beige rett.
- 7688908 bianco rett.
- 7688918 grigio rett.
- 7688828 nero rett.
- 7688938 tortora rett.

113 ▲ 4 ◻

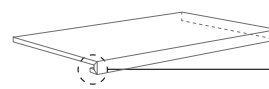

* angolare CR SX rett.

- 33,3x60 (13"x24")
- 7688900 beige rett.
- 7688910 bianco rett.
- 7688920 grigio rett.
- 7688930 nero rett.
- 7688940 tortora rett.

123 ▲ 2 ◻

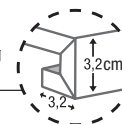

* angolare CR DX rett.

- 33,3x60 (13"x24")
- 7688899 beige rett.
- 7688909 bianco rett.
- 7688919 grigio rett.
- 7688929 nero rett.
- 7688939 tortora rett.

123 ▲ 2 ◻

IMBALLI packing - emballages - verpackung - УПАКОВКА

F.TO NOMINALE / NOMINAL SIZE	mm.	PCS / BOX	M2 / BOX	BOX / PLT	M2 / PLT	KG. / PLT
60x120 rett.	9	2	1,44	36	51,84	1170
60x60 rett.	9	3	1,08	40	43,20	900
30x60 rett.	9	7	1,26	40	50,40	1120
30x30 rett.	9	11	0,99	48	47,52	1056
15x15 non rett.	8	46	1,04	75	78	1200
30x30 mosaico	10	11	1,00	-	-	-

district roc | stone effect

saime

floor indoor: **bianco rett. 60x60** (24"x24")
floor outdoor: **bianco roc rett. 60x60** (24"x24")
wall outdoor: **grigio roc rett. 30x60** (12"x24")

district roc

bianco roc



formati modulari

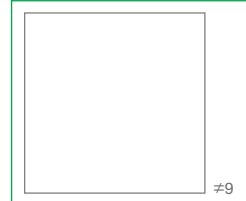

60x60 (24"x24")
rett. 78 ●
8600940 bianco roc rett.
8600950 grigio roc rett.
8600930 beige roc rett.



30x60 (12"x24")
rett. 78 ●
8600941 bianco roc rett.
8600951 grigio roc rett.
8600931 beige roc rett.

beige roc



PEZZI SPECIALI

trims - pieces speciales
formstücke - СОБЫЕЭЛЕМЕНТЫ

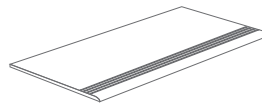

gradino step rett.
30x60 (12"x24")
8600944 bianco roc rett.
8600934 beige roc rett.
8600954 grigio roc rett.
48 ▲ 7 ◻

grigio roc



POSA 1/4



FUGA >3 mm



DIN 51130
R11



DIN 51097
A+B+C

district roc | stone effect

IMBALLI packing - emballages - verpackung - УПАКОВКА

F.TO NOMINALE / NOMINAL SIZE	mm.	PCS / BOX	M2 / BOX	BOX / PLT	M2 / PLT	KG. / PLT
60x60 rett.	9	3	1,08	40	43,20	900
30x60 rett.	9	7	1,26	40	50,40	1120

eternity | stone effect

COLORI

colours - couleurs - farbe - ЦВЕТА

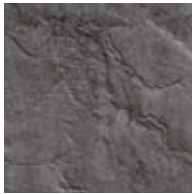

black



grey

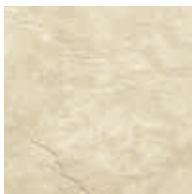

almond



gold



forest

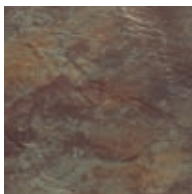

multicolor

FORMATI

sizes - formats - format - ФОРМАТЫ



30x60 (12"x24")

≠9



45x45 (18"x18")

≠9



30x30 (12"x12")

≠8

GM

V2

BLACK
GREY
ALMOND
GOLD

V3

FOREST
MULTICOLOR



POSA 1/4



FUGA >3 mm



DIN 51130
R10



DIN 51097
A+B

eternity | stone effect

almond



30x60 (12"x24") 68 ●
6500371 almond
6500391 gold
6500381 forest
6500401 multicolor
7670965 grey
7670975 black

gold



45x45 (18"x18") 64 ●
6411351 almond
6411371 gold
6411361 forest
6411381 multicolor
7671025 grey
7671031 black

forest

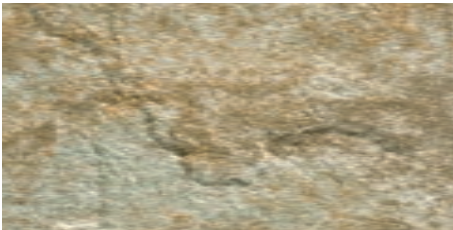

30x30 (12"x12") 62 ●
6434451 almond
6434471 gold
6434461 forest
6434481 multicolor
7671141 grey
7671151 black

multicolor

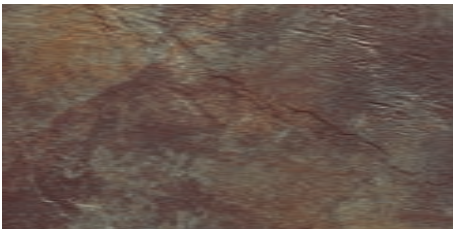

grey



black

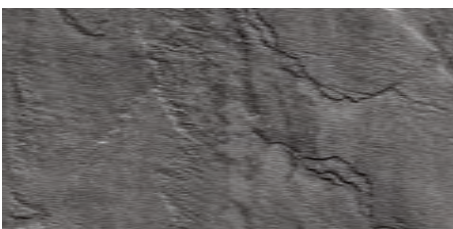

mosaico 3x3 (1,2"x1,2") 147 ●

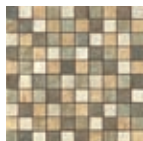

30x30 (12"x12")
7668871 mix caldo

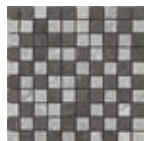

30x30 (12"x12")
7673201 mix freddo

muretto 2,5x5 (1"x2") 139 ●



30x30 (12"x12")
7668861 mix caldo



30x30 (12"x12")
7673191 mix freddo

PEZZI SPECIALI trims - pieces speciales - formstücke - СОБИЕЭЛЕМЕНТЫ



battiscopa
7,5x30 (3"x12")
6434771 almond
6434761 forest
6434781 multicolor
6434751 gold
7671181 grey
7671191 black
12 ▲ 32 ◻

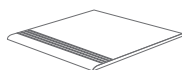

gradino step
30x30 (12"x12")
6434731 almond
6434721 forest
6434741 multicolor
6434711 gold
7671201 grey
7671211 black
30 ▲ 11 ◻



elemento elle pressa
15x30x3,5 (6"x12"x1,4")
7671156 forest
7671157 multicolor
7671154 gold
7671153 grey
7671152 black
44 ▲ 8 ◻

eternity | stone effect

IMBALLI packing - emballages - verpackung - УПАКОВКА

F.TO NOMINALE / NOMINAL SIZE	mm.	PCS / BOX	M2 / BOX	BOX / PLT	M2 / PLT	KG. / PLT
30x60	9	7	1,26	40	50,4	989
45x45	9	7	1,42	26	36,92	709
30x30	8	13	1,17	48	56,16	960
30x30 mosaico/muretto	9	11	1	30	30	570

frammenta | stone effect



frammenta

COLORI

colours - couleurs - farbe - ЦВЕТА



bianco

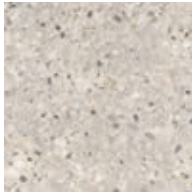

perla

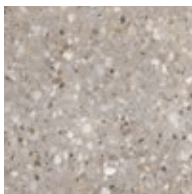

taupe

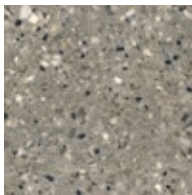

grigio

FORMATI

sizes - formats - format - ФОРМАТЫ

formati modulari



60x120 (24"x47") RETT. $\neq 9$



60x60 (24"x24") RETT. $\neq 9$



30x60 (12"x24") RETT. $\neq 9$

> pag. 58

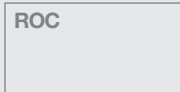

30x60 (12"x24") NON RETT.
29,7x59,5 (12"x24") RETT.

> pag. 250

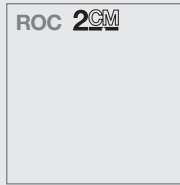

60x60 (24"x24") RETT. $\neq 20$

2 FINITURE

finishes - surfaces
Oberfläche - ПОВЕРХНОСТИ

Naturale

Lucido

GM

V3



POSA 1/4



FUGA 2 mm
PER RETT.



FUGA >3 mm
PER NON RETT.

frammenta | stone effect

bianco



perla



60x120 (24"x47")

naturale rett.

86 ●

8658605 bianco nat. rett.

8654625 perla nat. rett.

8654635 taupe nat. rett.

8658445 grigio nat. rett.

lucido rett.

103 ●

8601171 bianco luc. rett.

8601191 perla luc. rett.

8601201 taupe luc. rett.

8601181 grigio luc. rett.



60x60 (24"x24")

naturale rett.

78 ●

8658155 bianco nat. rett.

8658175 perla nat. rett.

8658165 taupe nat. rett.

8658465 grigio nat. rett.

lucido rett.

95 ●

8601170 bianco luc. rett.

8601190 perla luc. rett.

8601200 taupe luc. rett.

8601180 grigio luc. rett.



30x60 (12"x24")

naturale rett.

78 ●

8658195 bianco nat. rett.

8658215 perla nat. rett.

8658205 taupe nat. rett.

8658475 grigio nat. rett.

lucido rett.

95 ●

8601172 bianco luc. rett.

8601192 perla luc. rett.

8601202 taupe luc. rett.

8601182 grigio luc. rett.

frammenta | stone effect

taupe

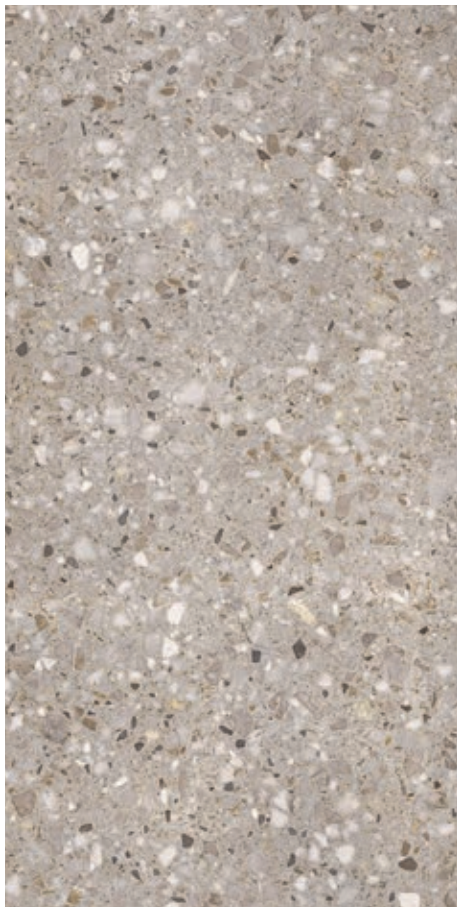

grigio

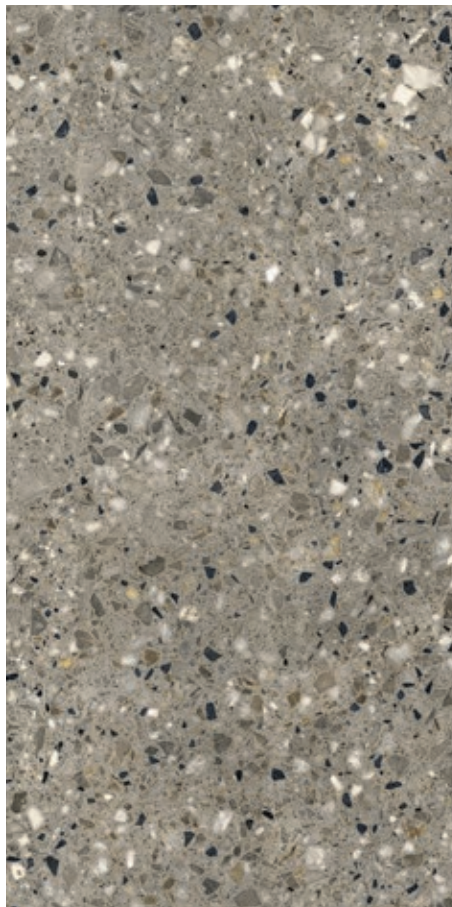

mosaico 5x5 (2"x2")



30x30 (12"x12")
7658196 bianco nat. rett. 124 ●
7659116 bianco luc. rett. 131 ●

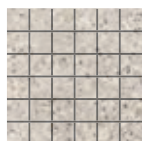

30x30 (12"x12")
7658216 perla nat. rett. 124 ●
7659136 perla luc. rett. 131 ●



30x30 (12"x12")
7658206 taupe nat. rett. 124 ●
7659126 taupe luc. rett. 131 ●

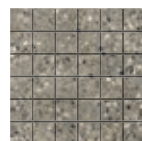

30x30 (12"x12")
7658477 grigio nat. rett. 124 ●
7658516 grigio luc. rett. 131 ●

PEZZI SPECIALI trims - pieces speciales - formstücke - СОБЫЕЭЛЕМЕНТЫ



battiscopa naturale rett.
7,5x60 (3"x24")
8678198 bianco nat. rett.
8658218 perla nat. rett.
8678208 taupe nat. rett.
8658479 grigio nat. rett.
24 ▲ 14 ◻

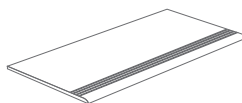

gradino step naturale rett.
30x60 (12"x24")
8658197 bianco nat. rett.
8658217 perla nat. rett.
8658207 taupe nat. rett.
8658478 grigio nat. rett.
48 ▲ 7 ◻

battiscopa lucido rett.
7,5x60 (3"x24")
8601173 bianco luc. rett.
8601193 perla luc. rett.
8601203 taupe luc. rett.
8601183 grigio luc. rett.
28 ▲ 14 ◻

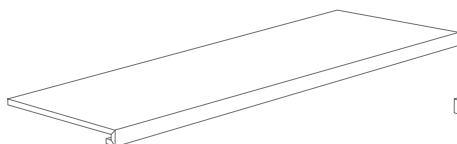

* gradone CR naturale rett.
33,3x120 (13"x47")
7654608 bianco nat. rett.
7654628 perla nat. rett.
7654638 taupe nat. rett.
7658449 grigio nat. rett.
141 ▲ 4 ◻

gradone CR lucido rett.
33,3x120 (13"x47")
7659074 bianco luc. rett.
7659098 perla luc. rett.
7659088 taupe luc. rett.
7658499 grigio luc. rett.
145 ▲ 4 ◻

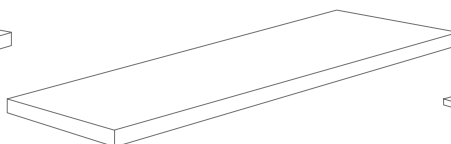

* angolare CR SX naturale rett.
33,3x120 (13"x47")
7654607 bianco nat. rett.
7654627 perla nat. rett.
7654637 taupe nat. rett.
7658448 grigio nat. rett.
148 ▲ 2 ◻

angolare CR SX lucido rett.
33,3x120 (13"x47")
7659077 bianco luc. rett.
7659097 perla luc. rett.
7659087 taupe luc. rett.
7658497 grigio luc. rett.
150 ▲ 2 ◻

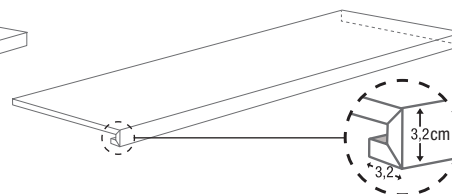

* angolare CR DX naturale rett.
33,3x120 (13"x47")
7654606 bianco nat. rett.
7654626 perla nat. rett.
7654636 taupe nat. rett.
7658447 grigio nat. rett.
148 ▲ 2 ◻

angolare CR DX lucido rett.
33,3x120 (13"x47")
7659076 bianco luc. rett.
7659096 perla luc. rett.
7659086 taupe luc. rett.
7658496 grigio luc. rett.
150 ▲ 2 ◻

frammenta | stone effect

IMBALLI packing - emballages - verpackung - УПАКОВКА

F.TO NOMINALE / NOMINAL SIZE	mm.	PCS / BOX	M2 / BOX	BOX / PLT	M2 / PLT	KG. / PLT
60x120 rett.	9	2	1,44	36	51,84	1170
60x60 rett.	9	3	1,08	40	43,20	900
30x60 rett.	9	7	1,26	40	50,40	1120
30x30 mosaico	9	11	1	30	30	603

frammenta roc stone effect

frammenta roc

bianco roc

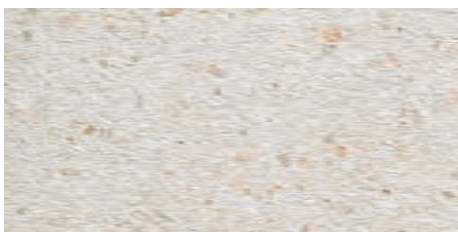

30x60 (12"x24")
non rett. 68 ●
 7694704 bianco roc
 7694724 perla roc
 7694744 taupe roc
 7694764 grigio roc

perla roc

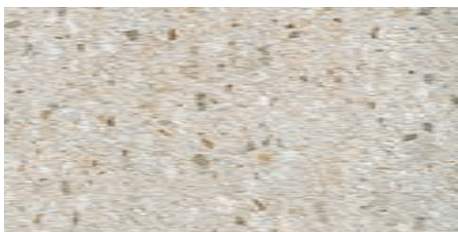

29,7x59,5 (12"x24")
rett. 76 ●
 7694713 bianco roc rett.
 7694734 perla roc rett.
 7694754 taupe roc rett.
 7694774 grigio roc rett.

taupe roc



PEZZI SPECIALI
 trims - pieces speciales
 formstücke - СОБЫЕЭЛЕМЕНТЫ

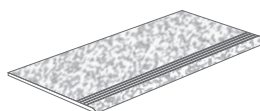

gradino step roc non rett.
 30x60 (12"x24")
 7694706 bianco roc
 7694726 perla roc
 7694746 taupe roc
 7694766 grigio roc
 48 ▲ 7 ◻

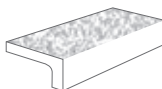

elemento elle pressa roc non rett.
 15x30x3,5 (6"x12"x 1,4")
 7694716 bianco roc
 7694736 perla roc
 7694756 taupe roc
 7694776 grigio roc
 44 ▲ 8 ◻

grigio roc



POSA 1/4



FUGA 2 mm
 PER RETT.



FUGA >3 mm
 PER NON RETT.



DIN 51130
 R11



DIN 51097
 A+B+C

frammenta roc | stone effect

IMBALLI packing - emballages - verpackung - УПАКОВКА

F.TO NOMINALE / NOMINAL SIZE	mm.	PCS / BOX	M2 / BOX	BOX / PLT	M2 / PLT	KG. / PLT
30x60 roc non rett.	9	7	1,26	40	50,40	940
29,7x59,5 roc rett.	9	7	1,24	40	49,60	920

galapagos | stone effect



galapagos

avorio



naturale



15x30 (6"x12") **65** ●
 7615001 avorio nat.
 7615011 dorato nat.
 7615021 terra nat.

grip



30x30 (12"x12") **62** ●
 7666971 avorio grip
 7667011 dorato grip
 7667021 terra grip
 7666981 verde grip
 7666991 antracite grip

2 FINITURE

finishes - surfaces
 Oberfläche - ПОВЕРХНОСТИ

Naturale

Grip

dorato



terra

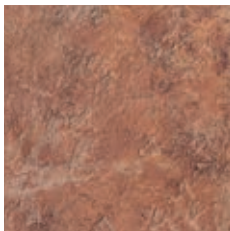

verde

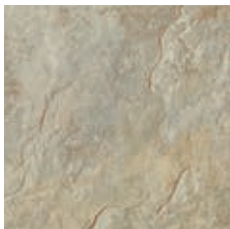

antracite

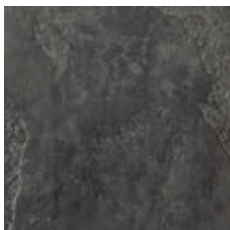

PEZZI SPECIALI

trims
 pieces speciales
 formstücke
 СОБЫЕЭЛЕМЕНТЫ

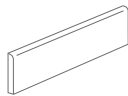

battiscopa
 7,5x30 (3"x12")
 7634530 avorio nat.
 7634540 dorato nat.
 7634510 terra nat.
12 ▲ **32** ◻



elemento elle pressa
 15x30x3,5 (6"x12"x1,4")
 7637679 avorio nat.
 7637689 dorato nat.
 7637699 terra nat.
44 ▲ **8** ◻

PEZZI SPECIALI

trims
 pieces speciales
 formstücke
 СОБЫЕЭЛЕМЕНТЫ

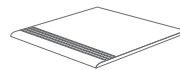

step grip
 30x30 (12"x12")
 7634442 antracite grip
 7634452 avorio grip
 7634462 dorato grip
 7634472 terra grip
 7634482 verde grip
30 ▲ **15** ◻



FUGA >3 mm



DIN 51130
 R11
 PER GRIP



DIN 51097
 A+B
 PER GRIP

galapagos | stone effect

IMBALLI packing - emballages - verpackung - УПАКОВКА

F.TO NOMINALE / NOMINAL SIZE	mm.	PCS / BOX	M2 / BOX	BOX / PLT	M2 / PLT	KG. / PLT
30x30	8	13	1,17	48	56,16	960
15x30	8	23	1,04	75	78	1239

kaleido | stone effect



COLORI

colours - couleurs - farbe - ЦВЕТА



avorio



bianco



beige



cenere

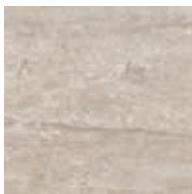

mandorla



grigio



cappuccino



nero

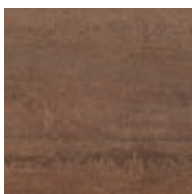

marrone

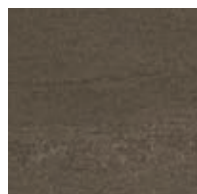

mokka

FORMATI

sizes - formats - format - ФОРМАТЫ

formati modulari



60x120 (24"x47") RETT. #9



60x60 (24"x24") RETT. #9



30x60 (12"x24") RETT. #9



30x60 (12"x24") NON RETT. #9
29,7x59,5 (12"x24") RETT. #9



45x90 (18"x36") RETT. #10



45x45 (18"x18") NON RETT. #9
44,5x44,5 (18"x18") RETT. #9



30x30 (12"x12") NON RETT. #8
29,7x29,7 (12"x12") RETT. #9



15x15 (6"x6") NON RETT. #8

> pag. 74



30x60 (12"x24") #9



30x30 (12"x12") #8

2 FINITURE

finishes - surfaces

Oberfläche - ПОВЕРХНОСТИ

Naturale

Lappato



POSA 1/4



FUGA 2 mm
PER RETT.



FUGA >3 mm
PER NON RETT.

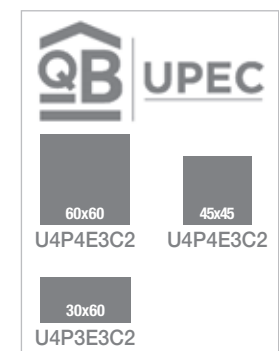

kaleido | stone effect

grigio



kaleido | stone effect

mosaico 5x5 (2"x2") 124 ●



30x30 (12"x12")
7665821 nat.
7673161 lapp.

listellato 131 ●



30x60 (12"x24")
7670441 nat.
7670451 lapp.

muretto 2,5x5 (1"x2") 139 ●



30x30 (12"x12")
7666081 ce/gr/ne

fascia joint 21 ▲



7,5x30 (3"x12")
7679251 joint cold (ce/gr/ne/bi)



60x120 (24"x47")
8600121 nat. rett. 86 ●
8600127 lapp. rett. 96 ●



60x60 (24"x24")
8600120 nat. rett. 78 ●
8600126 lapp. rett. 88 ●



30x60 (12"x24")
8600122 nat. rett. 78 ●
8600128 lapp. rett. 88 ●



30x60 (12"x24")
7665351 nat. 68 ●
29,7x59,5 (12"x24")
7665411 nat. rett. 76 ●
7665471 lapp. rett. 86 ●



45x90 (18"x36")
7655495 nat. rett. 84 ●
7655525 lapp. rett. 92 ●



45x45 (18"x18")
7653245 nat. 64 ●
44,5x44,5 (18"x18")
7663355 nat. rett. 76 ●
7653265 lapp. rett. 86 ●



30x30 (12"x12")
7666041 nat. 62 ●
29,7x29,7 (12"x12")
7665531 nat. rett. 86 ●
7665611 lapp. rett. 95 ●



15x15 (6"x6")
7670721 nat. 65 ●

cenere



mosaico 5x5 (2"x2") 124 ●



30x30 (12"x12")
7665841 nat.
7673151 lapp.

listellato 131 ●



30x60 (12"x24")
7670461 nat.
7670471 lapp.

muretto 2,5x5 (1"x2") 139 ●



30x30 (12"x12")
7666081 ce/gr/ne

fascia joint 21 ▲



7,5x30 (3"x12")
7679251 joint cold (ce/gr/ne/bi)

kaleido



60x120 (24"x47")
8600111 nat. rett. 86 ●
8600117 lapp. rett. 96 ●



60x60 (24"x24")
8600110 nat. rett. 78 ●
8600116 lapp. rett. 88 ●



30x60 (12"x24")
8600112 nat. rett. 78 ●
8600118 lapp. rett. 88 ●



30x60 (12"x24")
7665341 nat. 68 ●
29,7x59,5 (12"x24")
7665401 nat. rett. 76 ●
7665461 lapp. rett. 86 ●



45x90 (18"x36")
7656505 nat. rett. 84 ●
7656515 lapp. rett. 92 ●



45x45 (18"x18")
7653065 nat. 64 ●
44,5x44,5 (18"x18")
7653275 nat. rett. 76 ●
7661806 lapp. rett. 86 ●



30x30 (12"x12")
7666031 nat. 62 ●
29,7x29,7 (12"x12")
7665521 nat. rett. 86 ●
7665601 lapp. rett. 95 ●



15x15 (6"x6")
7670711 nat. 65 ●

kaleido | stone effect

bianco

kaleido | stone effect



mosaico 5x5 (2"x2") 124 ●



30x30 (12"x12")
7667451 nat.
7673141 lapp.

listellato 131 ●



30x60 (12"x24")
7670561 nat.
7670571 lapp.

muretto 2,5x5 (1"x2") 139 ●

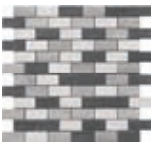

30x30 (12"x12")
7666081 ce/gr/ne

fascia joint 21 ▲



7,5x30 (3"x12")
7679251 joint cold (ce/gr/ne/bi)



60x120 (24"x47")
8600091 nat. rett. 86 ●
8600097 lapp. rett. 96 ●



60x60 (24"x24")
8600090 nat. rett. 78 ●
8600096 lapp. rett. 88 ●



30x60 (12"x24")
8600092 nat. rett. 78 ●
8600098 lapp. rett. 88 ●



30x60 (12"x24")
7667421 nat. 68 ●
29,7x59,5 (12"x24")
7667431 nat. rett. 76 ●
7667441 lapp. rett. 86 ●



45x90 (18"x36")
7656535 nat. rett. 84 ●
7657245 lapp. rett. 92 ●



45x45 (18"x18")
7653115 nat. 64 ●
44,5x44,5 (18"x18")
7663325 nat. rett. 76 ●
7661825 lapp. rett. 86 ●



30x30 (12"x12")
7666091 nat. 62 ●
29,7x29,7 (12"x12")
7669491 nat. rett. 86 ●
7666101 lapp. rett. 95 ●



15x15 (6"x6")
7671371 nat. 65 ●

nero



mosaico 5x5 (2"x2") 124 ●

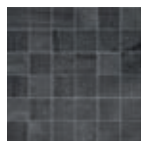

30x30 (12"x12")
7665851 nat.
7673181 lapp.

listellato 131 ●

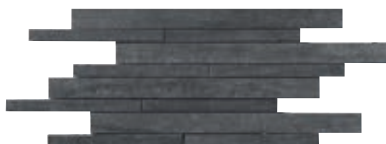

30x60 (12"x24")
7670481 nat.
7670491 lapp.

muretto 2,5x5 (1"x2") 139 ●

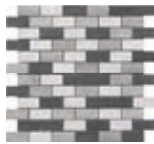

30x30 (12"x12")
7666081 ce/gr/ne

fascia joint 21 ▲

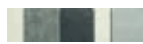

7,5x30 (3"x12")
7679251 joint cold (ce/gr/ne/bi)

kaleido

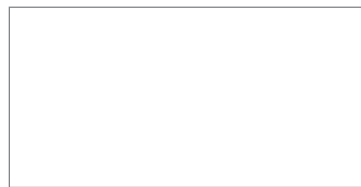

60x120 (24"x47")
8600141 nat. rett. 86 ●
8600147 lapp. rett. 96 ●



60x60 (24"x24")
8600140 nat. rett. 78 ●
8600146 lapp. rett. 88 ●



30x60 (12"x24")
8600142 nat. rett. 78 ●
8600148 lapp. rett. 88 ●



30x60 (12"x24")
7665361 nat. 68 ●
29,7x59,5 (12"x24")
7665421 nat. rett. 76 ●
7665481 lapp. rett. 86 ●



45x90 (18"x36")
7655505 nat. rett. 84 ●
7655535 lapp. rett. 92 ●



45x45 (18"x18")
7653235 nat. 64 ●
44,5x44,5 (18"x18")
7663345 nat. rett. 76 ●
7653255 lapp. rett. 86 ●



30x30 (12"x12")
7666061 nat. 62 ●
29,7x29,7 (12"x12")
7665541 nat. rett. 86 ●
7665621 lapp. rett. 95 ●



15x15 (6"x6")
7670701 nat. 65 ●

kaleido | stone effect

cappuccino

kaleido | stone effect



mosaico 5x5 (2"x2") 124 ●



30x30 (12"x12")
7674811 nat.
7674821 lapp.

listellato 131 ●



30x60 (12"x24")
7674831 nat.
7674841 lapp.

muretto 2,5x5 (1"x2") 139 ●



30x30(12"x12")
7678541 av/ma/ca

fascia joint 21 ▲



7,5x30 (3"x12")
7679241 joint warn (mo/ca/ma/av)



60x120 (24"x47")
8600101 nat. rett. 86 ●
8600107 lapp. rett. 96 ●



60x60 (24"x24")
8600100 nat. rett. 78 ●
8600106 lapp. rett. 88 ●



30x60 (12"x24")
8600102 nat. rett. 78 ●
8600108 lapp. rett. 88 ●



30x60 (12"x24")
7674701 nat. 68 ●
29,7x59,5 (12"x24")
7674711 nat. rett. 76 ●
7674721 lapp. rett. 86 ●



45x90 (18"x36")
7661645 nat. rett. 84 ●
7661675 lapp. rett. 92 ●



45x45 (18"x18")
7653095 nat. 64 ●
44,5x44,5 (18"x18")
7653305 nat. rett. 76 ●
7661785 lapp. rett. 86 ●



30x30 (12"x12")
7666631 nat. 62 ●
29,7x29,7 (12"x12")
7674751 nat. rett. 86 ●
7674761 lapp. rett. 95 ●



15x15 (6"x6")
7697361 nat. 65 ●

mandorla



mosaico 5x5 (2"x2") 124 ●



30x30 (12"x12")
7674931 nat.
7674941 lapp.

listellato 131 ●



30x60 (12"x24")
7674951 nat.
7674961 lapp.

muretto 2,5x5 (1"x2") 139 ●



30x30 (12"x12")
7678541 av/ma/ca

fascia joint 21 ▲



7,5x30 (3"x12")
7679241 joint warn (mo/ca/ma/av)

kaleido



60x120 (24"x47")
8600131 nat. rett. 86 ●
8600137 lapp. rett. 96 ●



60x60 (24"x24")
8600130 nat. rett. 78 ●
8600136 lapp. rett. 88 ●



30x60 (12"x24")
8600132 nat. rett. 78 ●
8600138 lapp. rett. 88 ●



30x60 (12"x24")
7674861 nat. 68 ●
29,7x59,5 (12"x24")
7674871 nat. rett. 76 ●
7674881 lapp. rett. 86 ●



45x90 (18"x36")
7661665 nat. rett. 84 ●
7661685 lapp. rett. 92 ●



45x45 (18"x18")
7653085 nat. 64 ●
44,5x44,5 (18"x18")
7653295 nat. rett. 76 ●
7661795 lapp. rett. 86 ●



30x30 (12"x12")
7666641 nat. 62 ●
30x30 (12"x12")
7674911 nat. rett. 86 ●
7674921 lapp. rett. 95 ●



15x15 (6"x6")
7697371 nat. 65 ●

kaleido | stone effect

avorio

kaleido | stone effect



mosaico 5x5 (2"x2") 124 ●



30x30 (12"x12")
7665801 nat.
7673121 lapp.

listellato 131 ●



30x60 (12"x24")
7670501 nat.
7670511 lapp.

muretto 2,5x5 (1"x2") 139 ●



30x30 (12"x12")
7666071 av/bg/ma



30x30 (12"x12")
7678541 av/ma/ca

fascia joint 21 ▲



7,5x30 (3"x12")
7679241 joint warn
(mo/ca/ma/av)



60x120 (24"x47")
8600071 nat. rett. 86 ●
8600077 lapp. rett. 96 ●



60x60 (24"x24")
8600070 nat. rett. 78 ●
8600076 lapp. rett. 88 ●



30x60 (12"x24")
8600072 nat. rett. 78 ●
8600078 lapp. rett. 88 ●



30x60 (12"x24")
7665331 nat. 68 ●
29,7x59,5 (12"x24")
7665391 nat. rett. 76 ●
7665451 lapp. rett. 86 ●



45x90 (18"x36")
7655565 nat. rett. 84 ●
7655575 lapp. rett. 92 ●



45x45 (18"x18")
7653105 nat. 64 ●
44,5x44,5 (18"x18")
7653315 nat. rett. 76 ●
7661805 lapp. rett. 86 ●



30x30 (12"x12")
7666011 nat. 62 ●
29,7x29,7 (12"x12")
7665511 nat. rett. 86 ●
7665591 lapp. rett. 95 ●



15x15 (6"x6")
7671381 nat. 65 ●

beige



mosaico 5x5 (2"x2") 124 ●



30x30 (12"x12")
7665831 nat.
7673131 lapp.

listellato 131 ●



30x60 (12"x24")
7670521 nat.
7670531 lapp.

muretto 2,5x5 (1"x2") 139 ●



30x30 (12"x12")
7666071 av/bg/ma

fascia joint 21 ▲



7,5x30 (3"x12")
7679241 joint warn (mo/ca/ma/av)

kaleido

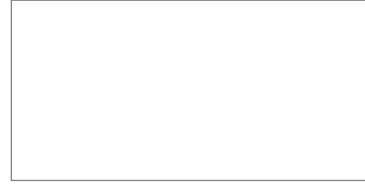

60x120 (24"x47")
8600081 nat. rett. 86 ●
8600087 lapp. rett. 96 ●



60x60 (24"x24")
8600080 nat. rett. 78 ●
8600086 lapp. rett. 88 ●



30x60 (12"x24")
8600082 nat. rett. 78 ●
8600088 lapp. rett. 88 ●



30x60 (12"x24")
7665371 nat. 68 ●
29,7x59,5 (12"x24")
7665431 nat. rett. 76 ●
7665491 lapp. rett. 86 ●



45x90 (18"x36")
7655515 nat. rett. 84 ●
7655545 lapp. rett. 92 ●



45x45 (18"x18")
7653075 nat. 64 ●
44,5x44,5 (18"x18")
7653285 nat. rett. 76 ●
7661775 lapp. rett. 86 ●



30x30 (12"x12")
7666021 nat. 62 ●
29,7x29,7 (12"x12")
7665561 nat. rett. 86 ●
7665631 lapp. rett. 95 ●



15x15 (6"x6")
7671391 nat. 65 ●

kaleido | stone effect

marrone



30x60 (12"x24")
7665381 nat. 68 ●
29,7x59,5 (12"x24")
7665441 nat. rett. 76 ●
7665501 lapp. rett. 86 ●

mosaico 5x5 (2"x2") 124 ●

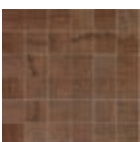

30x30 (12"x12")
7665811 nat.
7673171 lapp.

listellato 131 ●



30x60 (12"x24")
7670541 nat.
7670551 lapp.

muretto 2,5x5 (1"x2") 139 ●



30x30 (12"x12")
7666071 av/bg/ma

fascia joint 21 ▲



7,5x30 (3"x12")
7679241 joint warn (mo/ca/ma/av)

mokka



30x60 (12"x24")
7679011 nat. 68 ●
29,7x59,5 (12"x24")
7679031 nat. rett. 76 ●
7679051 lapp. rett. 86 ●

mosaico 5x5 (2"x2") 124 ●

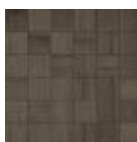

30x30 (12"x12")
7679071 nat.
7673122 lapp.

listellato 131 ●



30x60 (12"x24")
7679201 nat.
7679221 lapp.

fascia joint 21 ▲



7,5x30 (3"x12")
7679241 joint warn (mo/ca/ma/av)

kaleido | stone effect

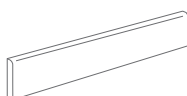

battiscopa

7,5x60 (3"x24")

- 7669431 bianco nat.
- 7669321 cenere nat.
- 7669331 grigio nat.
- 7669421 nero nat.
- 7669301 avorio nat.
- 7669311 beige nat.
- 7669411 marrone nat.
- 7674851 mandorla nat.
- 7674571 cappuccino nat.
- 7679101 mokka nat.

24 ▲ 14 📦

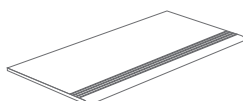

gradino step

30x60 (12"x24")

- 7667461 bianco nat.
- 7666769 cenere nat.
- 7666789 grigio nat.
- 7666799 nero nat.
- 7666779 avorio nat.
- 7666809 beige nat.
- 7666819 marrone nat.
- 7674481 mandorla nat.
- 7674471 cappuccino nat.
- 7667463 mokka nat.

48 ▲ 7 📦

battiscopa rett.

7,5x60 (3"x24")

- 8600093 bianco nat. rett.
- 8600113 cenere nat. rett.
- 8600123 grigio nat. rett.
- 8600143 nero nat. rett.
- 8600073 avorio nat. rett.
- 8600083 beige nat. rett.
- 8600133 mandorla nat. rett.
- 8600103 cappuccino nat. rett.

24 ▲ 14 📦

gradino step rett.







30x60 (12"x24")

- 8600094 bianco nat. rett.
- 8600114 cenere nat. rett.
- 8600124 grigio nat. rett.
- 8600144 nero nat. rett.
- 8600074 avorio nat. rett.
- 8600084 beige nat. rett.
- 8600134 mandorla nat. rett.
- 8600104 cappuccino nat. rett.

48 ▲ 7 📦

kaleido | stone effect

IMBALLI packing - emballages - verpackung - УПАКОВКА

F.TO NOMINALE / NOMINAL SIZE	 mm.	 PCS / BOX	 M2 / BOX	 BOX / PLT	 M2 / PLT	 KG. / PLT
60x120 rett.	9	2	1,44	36	51,84	1170
60x60 rett.	9	3	1,08	40	43,20	900
30x60 rett./non rett.	9	7	1,26	40	50,40	1120
29,7x59,5 rett.	9	7	1,24	40	49,6	1000
45x90 rett.	10	3	1,215	30	36,45	840
45x45 non rett.	9	7	1,42	26	36,92	709
44,5x44,5 rett.	9	7	1,39	26	36,14	694
30x30 non rett.	8	13	1,17	48	56,16	960
29,7x29,7 rett.	9	11	0,97	48	46,56	912
15x15 non rett.	8	46	1,04	75	78	1239
30x30 mosaico - muretto	9	11	1	-	-	-
30x60 listellato	9	4	0,72	-	-	-
7,5x30 fascia joint	9	12	-	-	-	-



kaleido roc - stone effect

kaleido roc

COLORI

colours - couleurs - farbe - ЦВЕТА

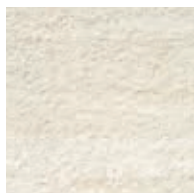

bianco roc



cenere roc



grigio roc

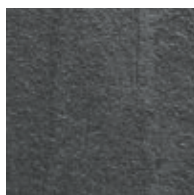

nero roc

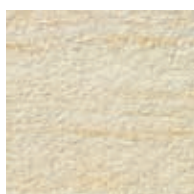

beige roc

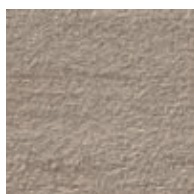

cappuccino roc

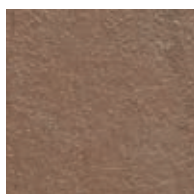

marrone roc

FORMATI

sizes - formats - format - ФОРМАТЫ



30x60 (12"x24")

#9



30x30 (12"x12")

#8

GM

V3



POSA 1/4



FUGA >3 mm



DIN 51130
R11



DIN 51097
A+B+C

kaleido roc | stone effect

bianco roc

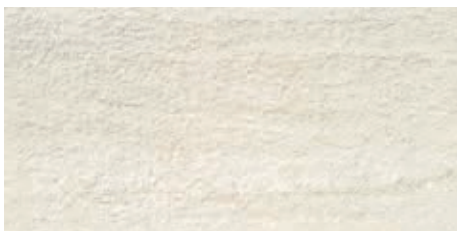

beige roc

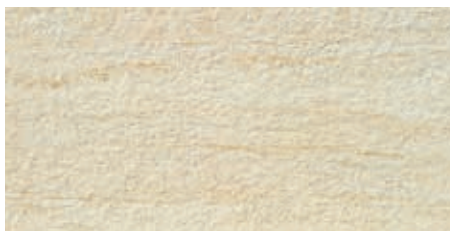

30x60 (12"x24") 68 ●
7672271 bianco roc
7672261 cenere roc
7672241 grigio roc
7677731 nero roc
7672251 beige roc
7677881 cappuccino roc

cenere roc



cappuccino roc

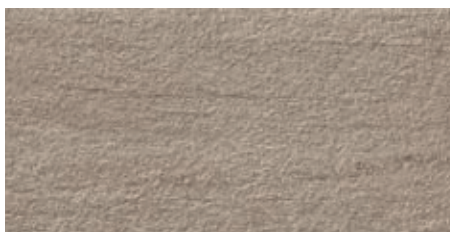

30x30 (12"x12") 62 ●
7666691 bianco roc
7666681 cenere roc
7666671 grigio roc
7666661 nero roc
7666701 marrone roc
7666693 beige roc

kaleido roc | stone effect

grigio roc



marrone roc

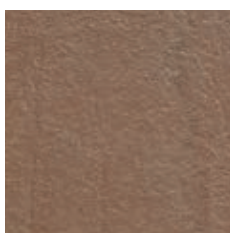

nero roc



mosaico 5x5 (2"x2") 124 ●



30x30 (12"x12")
7666077 bianco roc

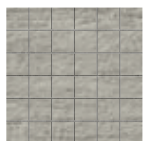

30x30 (12"x12")
7665878 cenere roc



30x30 (12"x12")
7665823 grigio roc

muretto 2,5x5 (1"x2") 139 ●

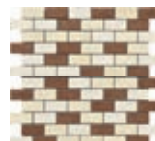

30x30 (12"x12")
7666073 Bi/Bg/Ma roc



30x30 (12"x12")
7665879 nero roc



30x30 (12"x12")
7666076 cappuccino roc



30x30 (12"x12")
7666075 beige roc



30x30 (12"x12")
7666074 Ce/Gr/Ne roc

PEZZI SPECIALI trims - pieces speciales - formstücke - СОБЫЕЭЛЕМЕНТЫ

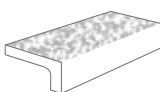

elemento elle pressa

15x30x3,5 (6"x12"x1,4")

- 7675009 grigio roc
- 7674979 beige roc
- 7674999 cenere roc
- 7674989 bianco roc
- 7675089 cappuccino roc
- 7675019 marrone roc
- 7655030 nero roc

44 ▲ 8 ◻

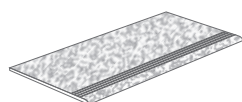

gradino step

30x60 (12"x24")

- 7672365 grigio roc
- 7672375 beige roc
- 7672385 cenere roc
- 7672395 bianco roc
- 7672396 cappuccino roc
- 7677736 nero roc

48 ▲ 7 ◻

IMBALLI packing - emballages - verpackung - УПАКОВКА

F.TO NOMINALE / NOMINAL SIZE	mm.	PCS / BOX	M2 / BOX	BOX / PLT	M2 / PLT	KG. / PLT
30x60	9	7	1,26	40	50,4	989
30x30	8	13	1,17	48	56,16	1020
30x30 mosaico-muretto	9	11	1	-	-	-

luserna
stone effect

COLORI

colours - couleurs - farbe - ЦВЕТА



beige

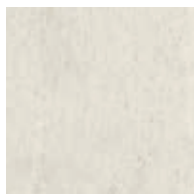

bianco



grigio



fumo



nero

FORMATI

sizes - formats - format - ФОРМАТЫ



≠9

30x60 (12"x24") NON RETT.

29,7x59,5 (12"x24") RETT.



≠8

30x30 (12"x12") NON RETT.



≠8

15x30 (6"x12") NON RETT.

> pag. 82

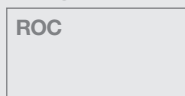

ROC

≠9

30x60 (12"x24") NON RETT.

29,7x59,5 (12"x24") RETT.



ROC

30x30 (12"x12") NON RETT. ≠8

29,7x29,7 (12"x12") RETT. ≠9



ROC

15x30 (6"x12") NON RETT. ≠8

14,8x29,7 (6"x12") RETT. ≠9



ROC

15x15 (6"x6") NON RETT. ≠8

14,8x14,8 (6"x6") RETT. ≠9

2 FINITURE

finishes - surfaces

Oberfläche - ПОВЕРХНОСТИ

Naturale

Lappato

GM

V2



POSA 1/4



FUGA 2 mm
PER RETT.



FUGA >3 mm
PER NON RETT.



DIN 51130
R10
PER NATURALE



DIN 51130
R9
PER LAPPATO

luserna | stone effect

bianco



30x60 (12"x24")

non rett.

68 ●

7667581 bianco

7667621 beige

7667591 grigio

7667601 fumo

7667611 nero

beige

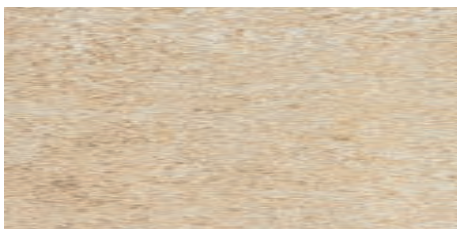

29,7x59,5 (12"x24")

rett.

76 ●

7667631 bianco rett.

7667681 beige rett.

7667651 grigio rett.

7667661 fumo rett.

7667671 nero rett.

lappato rett.

86 ●

7667791 bianco lapp. rett.

7667831 beige lapp. rett.

7667801 grigio lapp. rett.

7667811 fumo lapp. rett.

7667821 nero lapp. rett.

grigio

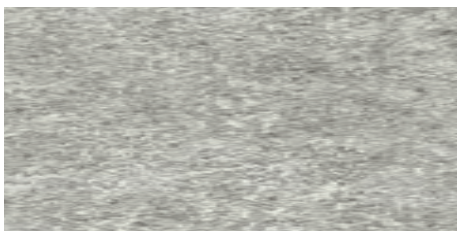

30x30 (12"x12")

non rett.

62 ●

7666891 bianco

7666881 beige

7666821 grigio

fumo

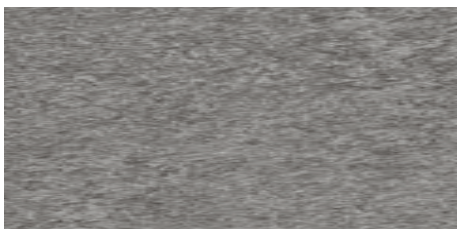

15x30 (6"x12")

non rett.

65 ●

7666111 bianco

7666151 beige

7666121 grigio

nero

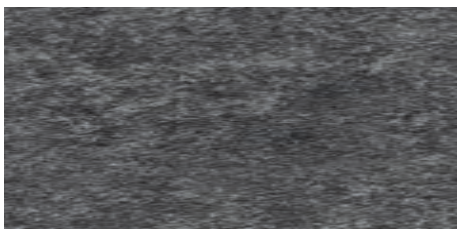

mosaico 5x5 (2"x2") 124 ●

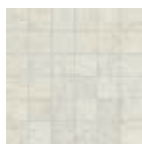

30x30 (12"x12")
7669031 bianco nat.



30x30 (12"x12")
7669011 beige nat.



30x30 (12"x12")
7669071 grigio nat.

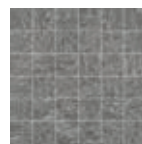

30x30 (12"x12")
7669051 fumo nat.

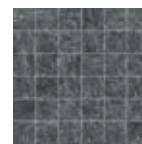

30x30 (12"x12")
7669091 nero nat.

grid 1,5x10 (0,6"x3,75") 135 ●

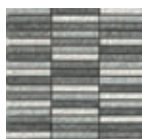

30x30 (12"x12")
7669222 mosaico mix

PEZZI SPECIALI trims - pieces speciales - formstücke - собьезэлементы

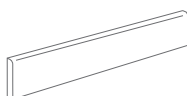

battiscopa non rett.
7,5x60 (3"x24")
7668141 bianco nat.
7668161 grigio nat.
7668151 fumo nat.
7668171 nero nat.
7668131 beige nat.

24 ▲ 14 ◻

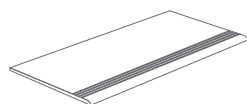

gradino step non rett.
30x60 (12"x24")
7668191 bianco nat.
7668211 grigio nat.
7668201 fumo nat.
7668221 nero nat.
7668181 beige nat.

48 ▲ 7 ◻

luserna | stone effect

IMBALLI packing - emballages - verpackung - УПАКОВКА

F.TO NOMINALE / NOMINAL SIZE	mm.	PCS / BOX	M2 / BOX	BOX / PLT	M2 / PLT	KG. / PLT
30x60 non rett.	9	7	1,26	40	50,40	989
29,7x59,5 rett.	9	7	1,24	40	49,60	973
30x30 non rett.	8	13	1,17	48	56,16	960
15x30 non rett.	8	23	1,04	75	78,00	1239
30x30 mosaico	9	11	1,00	30	30,00	570

luserna roc | stone effect

saime

fumo roc 30x30 (12"x12")
bianco roc 15x30 (6"x12")

luserna roc

COLORI

colours - couleurs - farbe - ЦВЕТА

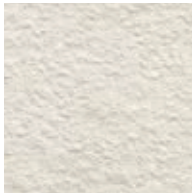

bianco



beige

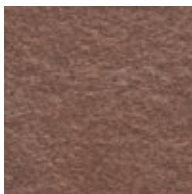

mattone

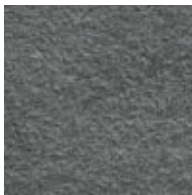

nero



fumo



grigio

FORMATI

sizes - formats - format - ФОРМАТЫ



#9

30x60 (12"x24") NON RETT.

29,7x59,5 (12"x24") RETT.



30x30 (12"x12") NON RETT.#8

29,7x29,7 (12"x12") RETT. #9



15x30 (6"x12") NON RETT.#8

14,8x29,7 (6"x12") RETT. #9



15x15 (6"x6") NON RETT. #8

14,8x14,8 (6"x6") RETT. #9

GM

V2



POSA 1/4



FUGA >3 mm



DIN 51130
R11



DIN 51097
A+B+C

luserna roc | stone effect

bianco roc



30x60 (12"x24")
non rett. 68 ●
7666871 bianco roc
7666861 beige roc
7666831 grigio roc
7666841 fumo roc
7666851 nero roc
7675921 mattone roc



30x30 (12"x12")
non rett. 62 ●
7637391 bianco roc
7637381 beige roc
7637351 grigio roc
7637361 fumo roc
7637371 nero roc
7666651 mattone roc

beige roc



29,7x59,5 (12"x24")
rett. 76 ●
7667201 bianco roc rett.
7667281 beige roc rett.
7667211 grigio roc rett.
7667221 fumo roc rett.
7667271 nero roc rett.
7675991 mattone roc rett.

29,7x29,7 (12"x12")
rett. 86 ●
7667291 bianco roc rett.
7667331 beige roc rett.
7667301 grigio roc rett.
7667311 fumo roc rett.
7667321 nero roc rett.

grigio roc

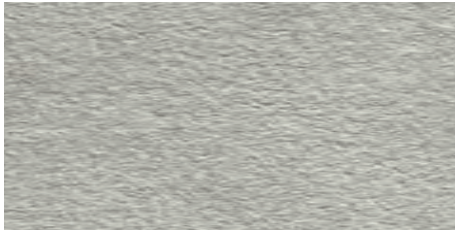

15x30 (6"x12")
non rett. 65 ●
7615041 bianco roc
7615031 beige roc
7615061 grigio roc
7615051 fumo roc
7615071 nero roc
7615032 mattone roc



15x15 (6"x6")
non rett. 65 ●
7697311 bianco roc
7697351 beige roc
7697321 grigio roc
7697331 fumo roc
7697341 nero roc
7697381 mattone roc

fumo roc

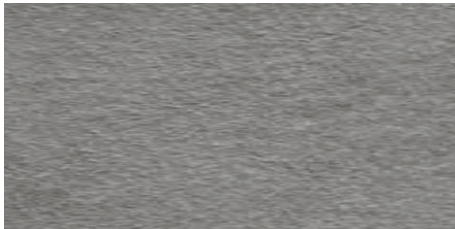

14,8x29,7 (6"x12")
rett. 84 ●
7667341 bianco roc rett.
7667381 beige roc rett.
7667351 grigio roc rett.
7667361 fumo roc rett.
7667371 nero roc rett.

14,8x14,8 (6"x6")
rett. 96 ●
7666581 bianco roc rett.
7666621 beige roc rett.
7666591 grigio roc rett.
7666601 fumo roc rett.
7666611 nero roc rett.
7675992 mattone roc rett.

nero roc

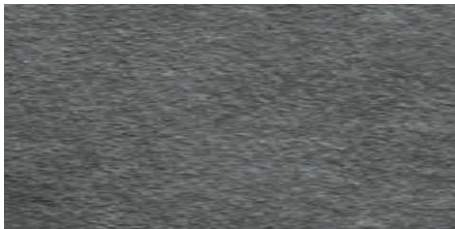

mattone roc

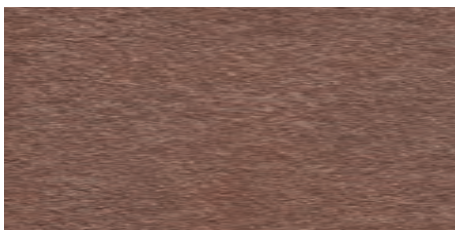

mosaico 5x5 (2"x2") 124 ●



30x30 (12"x12")
7669041 bianco roc



30x30 (12"x12")
7669021 beige roc



30x30 (12"x12")
7669081 grigio roc

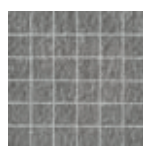

30x30 (12"x12")
7669061 fumo roc

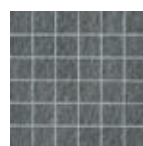

30x30 (12"x12")
7669101 nero roc

grid 1,5x10 (0,6"x3,75") 135 ●

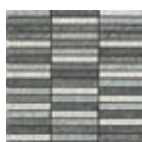

30x30 (12"x12")
7669221 mosaico mix roc

PEZZI SPECIALI trims - pieces speciales - formstücke - СОБЫЕЭЛЕМЕНТЫ

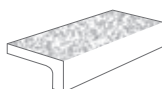

elemento elle pressa
15x30x3,5 (6"x12"x1,4")
7666489 bianco roc
7666509 grigio roc
7666499 fumo roc
7666519 nero roc
7666479 beige roc
7666518 mattone roc

44 ▲ 8 ◻

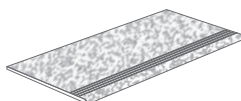

gradino step
30x60 (12"x24")
7668241 bianco roc
7668261 grigio roc
7668251 fumo roc
7668271 nero roc
7668231 beige roc

48 ▲ 7 ◻



* **gradone DP rett.**
33,3x29,7 (13"x12")
7690004 bianco roc rett.
7690034 grigio roc rett.
7690024 fumo roc rett.
7690044 nero roc rett.
7690014 beige roc rett.
7690054 mattone roc rett.

84 ▲ 4 ◻

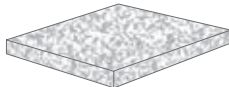

* **angolare DP SX rett.**
33,3x29,7 (13"x12")
7690124 bianco roc rett.
7690154 grigio roc rett.
7690144 fumo roc rett.
7690164 nero roc rett.
7690134 beige roc rett.
7690174 mattone roc rett.

110 ▲ 2 ◻

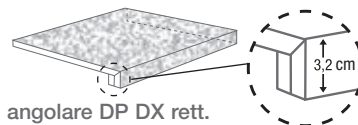

* **angolare DP DX rett.**
33,3x29,7 (13"x12")
7690064 bianco roc rett.
7690094 grigio roc rett.
7690084 fumo roc rett.
7690104 nero roc rett.
7690074 beige roc rett.
7690114 mattone roc rett.

110 ▲ 2 ◻

luserna roc | stone effect

IMBALLI packing - emballages - verpackung - УПАКОВКА

F.TO NOMINALE / NOMINAL SIZE	mm.	PCS / BOX	M2 / BOX	BOX / PLT	M2 / PLT	KG. / PLT
30x60 non rett.	9	7	1,26	40	50,40	989
29,7x59,5 rett.	9	7	1,24	40	49,60	973
30x30 non rett.	8	13	1,17	48	56,16	960
29,7x29,7 rett.	9	11	0,97	48	46,56	912
15x30 non rett.	8	23	1,04	75	78,00	1239
14,8x29,7 rett.	9	16	0,70	56	39,20	728
15x15 non rett.	8	46	1,04	75	78,00	1239
14,8x14,8 rett.	9	32	0,70	56	39,20	800,80
30x30 mosaico	9	11	1,00	30	30,00	570

morestone | stone effect

morestone

COLORI

colours - couleurs - farbe - ЦВЕТА



white

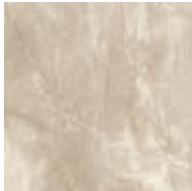

sand



grey



dark

FORMATI

sizes - formats - format - ФОРМАТЫ

naturale

formati modulari

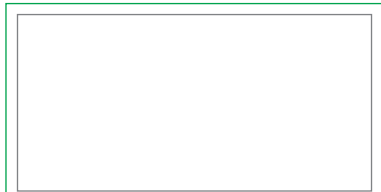

60x120 (24"x47") RETT. $\neq 9$

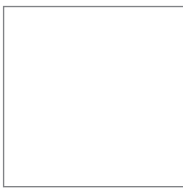

60x60 (24"x24") RETT. $\neq 9$



30x60 (12"x24") RETT.



30x60 (12"x24") NON RETT. $\neq 9$

grip

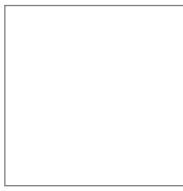

60x60 (24"x24") RETT. $\neq 9$

ONLY: grey

2 FINITURE

finishes - surfaces
Oberfläche - ПОВЕРХНОСТИ

Naturale

Grip

GM

V3



POSA 1/4



FUGA 2 mm
PER RETT.



FUGA >3 mm
PER NON RETT.



DIN 51130
R11
(GRIP)



DIN 51097
A+B+C
(GRIP)

morestone | stone effect

white



naturale



60x120 (24"x47")
rett.

86 ●

8601011 dark rett.
8601021 grey rett.
8601031 sand rett.
8601041 white rett.

grip



60x60 (24"x24")
rett.

78 ●

8601050 grey grip rett.

sand



60x60 (24"x24")
rett.

78 ●

8601010 dark rett.
8601020 grey rett.
8601030 sand rett.
8601040 white rett.



30x60 (12"x24")
rett.

78 ●

8601012 dark rett.
8601022 grey rett.
8601032 sand rett.
8601042 white rett.

grey



30x60 (12"x24")
non rett.

68 ●

7693571 dark
7693611 grey
7693581 sand
7693591 white

dark



mosaico 5x5 (2"x2") #9 124 ●



30x30 (12"x12")
7693911 white

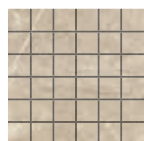

30x30 (12"x12")
7693921 sand

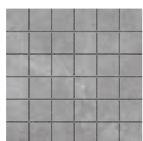

30x30 (12"x12")
7693931 grey

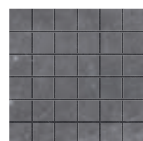

30x30 (12"x12")
7693941 dark

listellato #10 131 ●



30x60 (12"x24")
7693951 white



30x60 (12"x24")
7693961 sand



30x60 (12"x24")
7693971 grey



30x60 (12"x24")
7693981 dark

PEZZI SPECIALI trims - pieces speciales - formstücke - СОБИЕЭЛЕМЕНТЫ

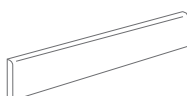

battiscopa rett.

7,5x60 (3"x24")

- 8601043 white rett.
- 8601033 sand rett.
- 8601023 grey rett.
- 8601013 dark rett.

24 ▲ 14 ▢

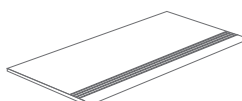

gradino step rett.

30x60 (12"x24")

- 8601044 white rett.
- 8601034 sand rett.
- 8601024 grey rett.
- 8601014 dark rett.

48 ▲ 7 ▢

IMBALLI packing - emballages - verpackung - УПАКОВКА

F.TO NOMINALE / NOMINAL SIZE	mm.	PCS / BOX	M2 / BOX	BOX / PLT	M2 / PLT	KG. / PLT
60x120 rett.	9	2	1,44	36	51,84	1170
60x60 rett.	9	3	1,08	40	43,20	900
30x60 rett./non rett.	9	7	1,26	40	50,40	1120
30x30 mosaico	9	11	1	-	-	-
30x60 listellato	10	4	0,72	-	-	-



phoenix | stone effect

phoenix

COLORI

colours - couleurs - farbe - ЦВЕТА



moon



sun

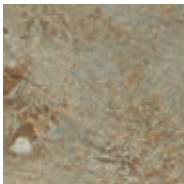

canyon

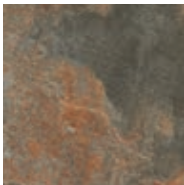

rainbow

FORMATI

sizes - formats - format - ФОРМАТЫ

naturale



≠9

30x60 (12"x24") NON RETT.

29,7x59,5 (12"x24") RETT.



≠9

15x15 (6"x6") NON RETT.

14,8x14,8 (6"x6") RETT.

grip



≠9

30x60 (12"x24") NON RETT.

2 FINITURE

finishes - surfaces

Oberfläche - ПОВЕРХНОСТИ

Naturale

Grip

GM

V4



POSA 1/4



FUGA 2 mm
PER RETT.



FUGA >3 mm
PER NON RETT.



DIN 51130
R11
(GRIP)



DIN 51097
A+B+C
(GRIP)

phoenix | stone effect

moon



sun

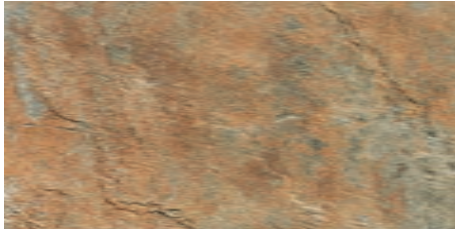

canyon



rainbow

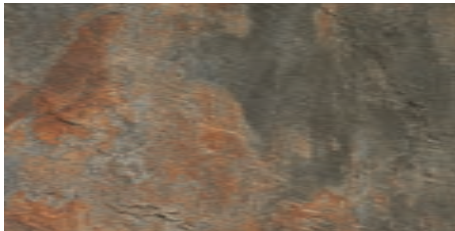

naturale



30x60 (12"x24")
non rett. 68 ●
 7679681 moon
 7679691 sun
 7679701 canyon
 7679721 rainbow

29,7x59,5 (12"x24")
rett. 76 ●
 7679731 moon rett.
 7679741 sun rett.
 7679751 canyon rett.
 7679761 rainbow rett.



15x15 (6"x6")
nat. 75 ●
 7697451 moon nat.
 7697471 sun nat.
 7697441 canyon nat.
 7697461 rainbow nat.

14,8x14,8 (6"x6")
rett. 96 ●
 7681001 moon rett.
 7681011 sun rett.
 7681021 canyon rett.
 7681031 rainbow rett.

grip



30x60 (12"x24")
grip non rett. 68 ●
 7693991 moon grip
 7694001 sun grip
 7694011 rainbow grip
 7694785 canyon grip

PEZZI SPECIALI

trims - pieces speciales - formstücke - СОБИЕЭЛЕМЕНТЫ

naturale

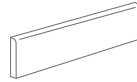

battiscopa
7,5x30 (3"x12")
 7679682 moon
 7679692 sun
 7679702 canyon
 7679722 rainbow

12 ▲ 32 ◻

grip

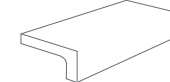

elemento elle pressa
15x30x3,5 (6"x12"x1,4")
 7693996 moon grip
 7694006 sun grip
 7694786 canyon grip
 7694016 rainbow grip

44 ▲ 8 ◻

mosaico nat. 5x5 (2"x2") 124 ●

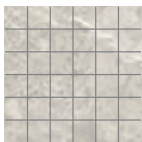

30x30 (12"x12")
 7679771 moon

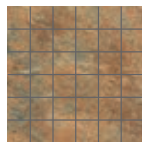

30x30 (12"x12")
 7679781 sun

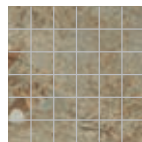

30x30 (12"x12")
 7679791 canyon



30x30 (12"x12")
 7679801 rainbow

mosaico nat. mix 5x5 (2"x2") 124 ●

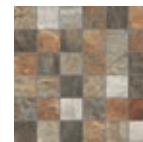

30x30 (12"x12")
 7679704 mix

brick nat. 5x15 (2"x6") 125 ●



30x30 (12"x12")
 7679811 moon



30x30 (12"x12")
 7679821 sun



30x30 (12"x12")
 7679831 canyon

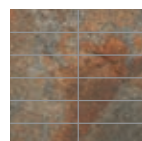

30x30 (12"x12")
 7679841 rainbow

phoenix



phoenix | stone effect

floor: moon 30x60 (12"x24")
wall: mosaico moon 5x5 (2"x2")

IMBALLI packing - emballages - verpackung - УПАКОВКА

F.TO NOMINALE / NOMINAL SIZE	mm.	PCS / BOX	M2 / BOX	BOX / PLT	M2 / PLT	KG. / PLT
30x60 non rett.	9	7	1,26	40	50,40	989
29,7x59,5 rett.	9	7	1,24	40	49,60	973
15x15 non rett.	9	46	1,04	75	78,00	1200
14,8x14,8 rett.	9	32	0,70	56	39,20	800,80
30x30 mosaico - brick	9	11	1	-	-	-

saime

titano | stone effect

COLORI

colours - couleurs - farbe - ЦВЕТА

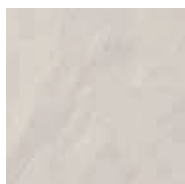

bianco

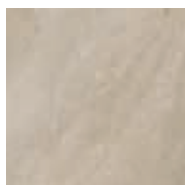

beige

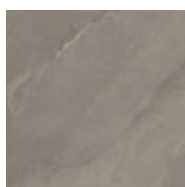

taupe

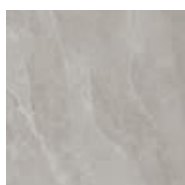

cenere



grigio

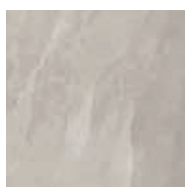

perla

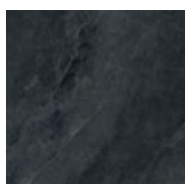

antracite

FORMATI

sizes - formats - format - ФОРМАТЫ

naturale

formati modulari



60x120 (24"x47") RETT. $\neq 9$



60x60 (24"x24") RETT. $\neq 9$



30x60 (12"x24") RETT. $\neq 9$



30x60 (12"x24") NON RETT. $\neq 9$



10x30 (4"x12") RETT. $\neq 9$

composizione modulo



60x120 (24"x47") RETT. $\neq 9$



60x90 (24"x36") RETT. $\neq 9$

30x60 (12"x24") RETT. $\neq 9$

grip

formati modulari



60x120 (24"x47") RETT. $\neq 9$



60x60 (24"x24") RETT. $\neq 9$



30x60 (12"x24") RETT. $\neq 9$



30x60 (12"x24") NON RETT. $\neq 9$

composizione modulo



60x120 (24"x47") RETT. $\neq 9$



60x90 (24"x36") RETT. $\neq 9$

30x60 (12"x24") RETT. $\neq 9$

> pag. 256

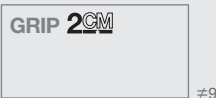

60x120 (24"x47") RETT. $\neq 9$
only: grigio - perla - beige



60x60 (24"x24") RETT. $\neq 9$
only: grigio - perla - beige

2 FINITURE

finishes - surfaces
Oberfläche - ПОВЕРХНОСТИ

Naturale

Grip



POSA 1/4



FUGA 2 mm
PER RETTIFICATO



FUGA >3 mm
PER NATURALE



DIN 51130
R11 (GRIP)



DIN 51097
A+B+C (GRIP)

titano | stone effect

bianco



cenere



grigio



titano | stone effect

naturale

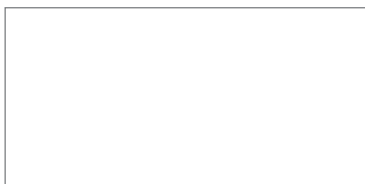

60x120 (24"x47")

rett.

86 ●

8661036 bianco nat. rett.
8661046 cenere nat. rett.
8661016 grigio nat. rett.
8661006 antracite nat. rett.



60x60 (24"x24")

rett.

78 ●

8661037 bianco nat. rett.
8661047 cenere nat. rett.
8661017 grigio nat. rett.
8661007 antracite nat. rett.



30x60 (12"x24")

rett.

78 ●

8661035 bianco nat. rett.
8661045 cenere nat. rett.
8661015 grigio nat. rett.
8661005 antracite nat. rett.



30x60 (12"x24")

non rett. 68 ●

7661125 bianco nat. rett.
7661135 cenere nat. rett.
7661105 grigio nat. rett.
7661004 antracite nat. rett.



10x30 (4"x12")

rett. 107 ●

8661038 bianco nat. rett.
8661048 cenere nat. rett.
8661018 grigio nat. rett.
8661008 antracite nat. rett.

antracite



mosaico 5x5 (2"x2") 124 ●



30x30 (12"x12")
7661126 bianco nat. rett.



30x30 (12"x12")
7661136 cenere nat. rett.



30x30 (12"x12")
7661015 grigio nat. rett.

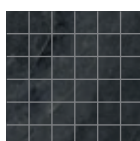

30x30 (12"x12")
7661005 antracite nat. rett.

listellato 131 ●

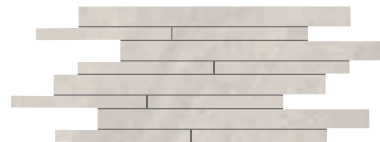

30x60 (12"x24")
7661036 bianco nat. rett.

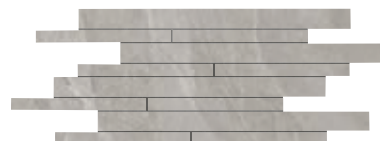

30x60 (12"x24")
7661046 cenere nat. rett.

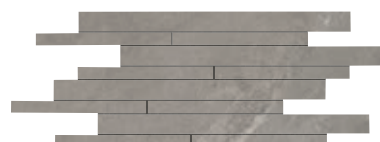

30x60 (12"x24")
7661016 grigio nat. rett.



30x60 (12"x24")
7661006 antracite nat. rett.

titano | stone effect

grip

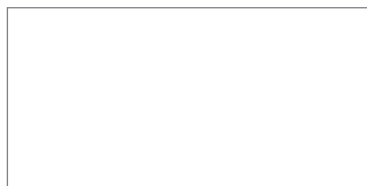

60x120 (24"x47")

rett.

86 ●

- 8661136 bianco grip rett.
- 8661146 cenere grip rett.
- 8661116 grigio grip rett.
- 8661106 antracite grip rett.



60x60 (24"x24")

rett.

78 ●

- 8661137 bianco grip rett.
- 8661147 cenere grip rett.
- 8661117 grigio grip rett.
- 8661107 antracite grip rett.



30x60 (12"x24")

rett.

78 ●

- 8661135 bianco grip rett.
- 8661145 cenere grip rett.
- 8661115 grigio grip rett.
- 8661105 antracite grip rett.



30x60 (12"x24")

non rett.

68 ●

- 7661035 bianco grip rett.
- 7661045 cenere grip rett.
- 7661014 grigio grip rett.
- 7661114 antracite grip rett.

beige



perla



taupe



titano | stone effect

naturale



60x120 (24"x47")

rett.

86 ●

8661026 beige nat. rett.
8661056 perla nat. rett.
8661066 taupe nat. rett.



60x60 (24"x24")

rett.

78 ●

8661027 beige nat. rett.
8661057 perla nat. rett.
8661067 taupe nat. rett.



30x60 (12"x24")

rett.

78 ●

8661025 beige nat. rett.
8661055 perla nat. rett.
8661065 taupe nat. rett.



30x60 (12"x24")

non rett.

68 ●

7661115 beige nat. rett.
7661145 perla nat. rett.
7661155 taupe nat. rett.



10x30 (4"x12")

rett.

107 ●

8661028 beige nat. rett.
8661058 perla nat. rett.
8661068 taupe nat. rett.

mosaico 5x5 (2"x2") 124 ●



30x30 (12"x12")
7661116 beige nat. rett.



30x30 (12"x12")
7661146 perla nat. rett.



30x30 (12"x12")
7661156 taupe nat. rett.

listellato 131 ●

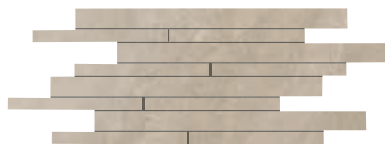

30x60 (12"x24")
7661026 beige nat. rett.

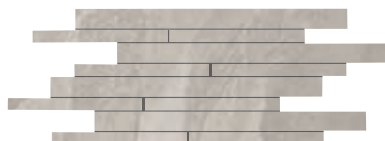

30x60 (12"x24")
7661056 perla nat. rett.

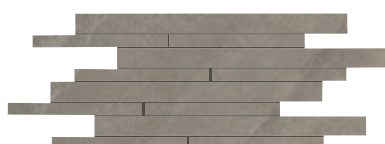

30x60 (12"x24")
7661066 taupe nat. rett.

grip



60x120 (24"x47")
rett. 86 ●
8661126 beige grip rett.
8661156 perla grip rett.
8661166 taupe grip rett.



60x60 (24"x24")
rett. 78 ●
8661127 beige grip rett.
8661157 perla grip rett.
8661167 taupe grip rett.



30x60 (12"x24")
rett. 78 ●
8661125 beige grip rett.
8661155 perla grip rett.
8661165 taupe grip rett.



30x60 (12"x24")
non rett. 68 ●
7661025 beige grip rett.
7661055 perla grip rett.
7661065 taupe grip rett.

titano | stone effect

COMPOSIZIONE MODULO 60x120 - 60x90 - 30x60 nat rett / grip rett

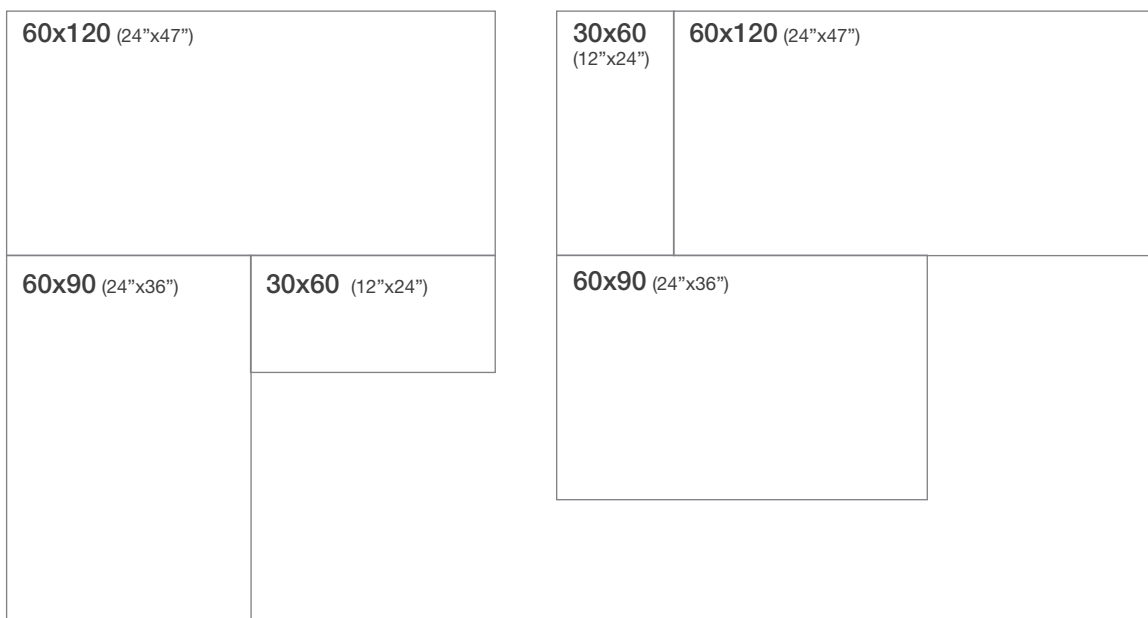

naturale rettificato

1 cp modulo

60x120 (24"x47")
60x90 (24"x36")
30x60 (12"x24")

rett. 94 ●
8661041 bianco nat. rett.
8661031 beige nat. rett.
8661051 cenere nat. rett.
8661021 grigio nat. rett.
8661111 antracite nat. rett.
8661061 perla nat. rett.
8661071 taupe nat. rett.

grip rettificato

1 cp modulo

60x120 (24"x47")
60x90 (24"x36")
30x60 (12"x24")

rett. 94 ●
8661141 bianco grip rett.
8661131 beige grip rett.
8661151 cenere grip rett.
8661121 grigio grip rett.
8661011 antracite grip rett.
8661161 perla grip rett.
8661171 taupe grip rett.

titano | stone effect

In ogni scatola troverete
1 composizione composta da
1 pezzo di 60x120, 1 pezzo di 60x90
e 1 pezzo di 30x60.
Il formato 60x90 non è vendibile
singolarmente.

PEZZI SPECIALI trims - pieces speciales - formstücke - СОБЫЕЭЛЕМЕНТЫ

naturale

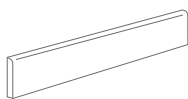

battiscopa rett.

7,5x60 (3"x24")

8661039 bianco nat. rett.
 8661029 beige nat. rett.
 8661049 cenere nat. rett.
 8661019 grigio nat. rett.
 8661009 antracite nat. rett.
 8661059 perla nat. rett.
 8661069 taupe nat. rett.

24 ▲ 14 ◻

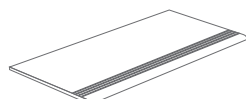

gradino step rett.

30x60 (12"x24")

8661040 bianco nat. rett.
 8661030 beige nat. rett.
 8661050 cenere nat. rett.
 8661020 grigio nat. rett.
 8661010 antracite nat. rett.
 8661060 perla nat. rett.
 8661070 taupe nat. rett.

48 ▲ 7 ◻

grip

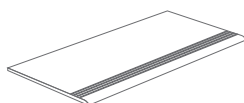

gradino step rett.







30x60 (12"x24")

8661140 bianco grip rett.
 8661130 beige grip rett.
 8661150 cenere grip rett.
 8661120 grigio grip rett.
 8661110 antracite grip rett.
 8661160 perla grip rett.
 8661170 taupe grip rett.

48 ▲ 7 ◻

titano | stone effect

IMBALLI packing - emballages - verpackung - УПАКОВКА

F.TO NOMINALE / NOMINAL SIZE	CP	 mm.	 PCS / BOX	 M2 / BOX	 BOX / PLT	 M2 / PLT	 KG. / PLT
60x120 rett.	-	9	2	1,44	36	51,84	1170
60x60 rett.	-	9	3	1,08	40	43,20	900
30x60 rett.	-	9	7	1,26	40	50,40	1120
30x60 non rett.	-	9	7	1,26	40	50,40	989
10x30 rett.	-	9	30	0,33	66	21,78	1320
composizione 60x120 60x90 30x60	1	9	1	1,44	36	51,84	1170
30x30 mosaico	-	9	11	1	-	-	-
30x60 listellato	-	9	4	0,72	-	-	-

volcano | stone effect



volcano

COLORI

colours - couleurs - farbe - ЦВЕТА



bianco



cenere



grigio



nero

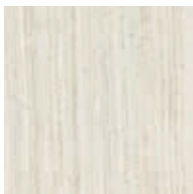

sabbia



tortora

FORMATI

sizes - formats - format - ФОРМАТЫ



30x60 (12"x24") NON RETT.
29,7x59,5 (12"x24") RETT.

2 FINITURE

finishes - surfaces
Oberfläche - ПОВЕРХНОСТИ

Naturale

Lappato



POSA 1/4



FUGA 2 mm
PER RETT.



FUGA >3 mm
PER NON RETT.

volcano | stone effect

bianco



sabbia



cenere



tortora



grigio



nero

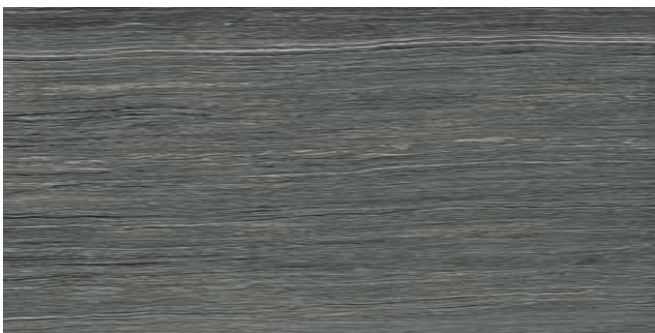

volcano | stone effect



30x60 (12"x24")

non rett.

68 ●

- 7672225 bianco nat.
- 7672095 cenere nat.
- 7672105 grigio nat.
- 7672215 nero nat.
- 7672235 sabbia nat.
- 7672085 tortora nat.



29,7x59,5 (12"x24")

rett.

76 ●

- 7672405 bianco nat. rett.
- 7672135 cenere nat. rett.
- 7672145 grigio nat. rett.
- 7672475 nero nat. rett.
- 7672445 sabbia nat. rett.
- 7672125 tortora nat. rett.

lappato rett.

86 ●

- 7672465 bianco lapp. rett.
- 7672175 cenere lapp. rett.
- 7672185 grigio lapp. rett.
- 7672485 nero lapp. rett.
- 7672495 sabbia lapp. rett.
- 7672165 tortora lapp. rett.

mosaico 5x5 (2"x2") 124 ●

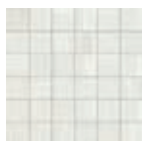

30x30 (12"x12")
7673855 bianco nat.
7673925 bianco lapp.

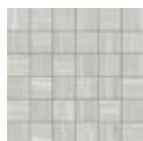

30x30 (12"x12")
7673865 cenere nat.
7673935 cenere lapp.

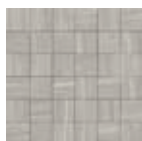

30x30 (12"x12")
7673875 grigio nat.
7673945 grigio lapp.

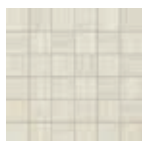

30x30 (12"x12")
7673905 sabbia nat.
7673975 sabbia lapp.

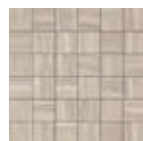

30x30 (12"x12")
7673915 tortora nat.
7673985 tortora lapp.



30x30 (12"x12")
7673895 nero nat.
7673965 nero lapp.

listello drops 42 ▲ 6 ◻



2x59,5 (0,8"x24")
7674135 bianco lapp. rett.



2x59,5 (0,8"x24")
7674145 cenere lapp. rett.



2x59,5 (0,8"x24")
7674175 nero lapp. rett.

listellato 131 ●



30x60 (12"x24")
7673995 bianco nat.
7674065 bianco lapp.



30x60 (12"x24")
7674005 cenere nat.
7674075 cenere lapp.



30x60 (12"x24")
7674015 grigio nat.
7674085 grigio lapp.



30x60 (12"x24")
7674045 sabbia nat.
7674115 sabbia lapp.



30x60 (12"x24")
7674055 tortora nat.
7674125 tortora lapp.



30x60 (12"x24")
7674035 nero nat.
7674105 nero lapp.

volcano | stone effect

PEZZI SPECIALI trims - pieces speciales - formstücke - СОБЫЕЭЛЕМЕНТЫ



battiscopa rett.
7,5x60 (3"x24")
7673435 bianco nat. rett.
7673445 cenere nat. rett.
7673455 grigio nat. rett.
7673475 nero nat. rett.
7673485 sabbia nat. rett.
7673495 tortora nat. rett.

24 ▲ 14 ◻

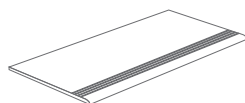

gradino step rett.
29,7x59,5 (12"x24")
7673575 bianco nat. rett.
7673585 cenere nat. rett.
7673595 grigio nat. rett.
7673615 nero nat. rett.
7673625 sabbia nat. rett.
7673635 tortora nat. rett.

48 ▲ 7 ◻

IMBALLI packing - emballages - verpackung - УПАКОВКА

F.TO NOMINALE / NOMINAL SIZE	mm.	PCS / BOX	M2 / BOX	BOX / PLT	M2 / PLT	KG. / PLT
30x60 non rett.	9	7	1,26	40	50,40	989
29,7x59,5 rett.	9	7	1,24	40	49,60	973
30x60 listellato	9	4	0,72	-	-	-
30x30 mosaico	9	11	1	-	-	-

collections 2021

02

concrete and terracotta effect

effetto cemento e cotto / imitation ciments et cotto
Cotto und Beton-Optik / Цемент и котто

borgate fiorentine	108
brera	110
concreta	114
cottoantico	118
cottocemento	122
ferrocemento	130
global	142
icon	152
icon roc	162
logica	164
neutra	168
salento	176
urbandeck	178
valencia	182

borgate fiorentine | concrete effect terracotta effect



borgate fiorentine

baruffi



33,3x33,3 (13"x13") 62 ●
 6440232 baruffi
 6440242 monterinardi
 6440212 falciani
 6440222 borgaccio

falciani



PEZZI SPECIALI
 trims - pieces speciales
 formstücke - СОБЫЕЭЛЕМЕНТЫ



battiscopa
 8x33,3 (3,2"x13")
 6440689 falciani
 6440691 borgaccio
 6440709 baruffi
 6440719 monterinardi
 12 ▲ 32 ◻

monterinardi



borgaccio



GS

V3



FUGA >3 mm

borgate fiorentine | concrete and terracotta effect

IMBALLI packing - emballages - verpackung - УПАКОВКА

F.TO NOMINALE / NOMINAL SIZE	mm.	PCS / BOX	M2 / BOX	BOX / PLT	M2 / PLT	KG. / PLT
33,3x33,3	8	14	1,55	44	68,2	1100

brera | concrete and terracotta effect



COLORI

colours - couleurs - farbe - ЦВЕТА

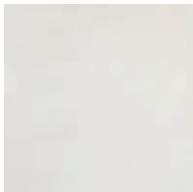

bianco



beige

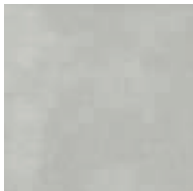

perla

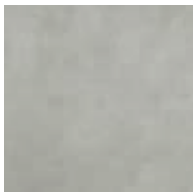

grigio

FORMATI

sizes - formats - format - ФОРМАТЫ

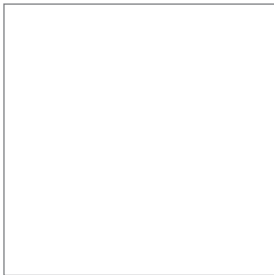

±10

90x90 (36"x36") RETT.

formati modulari



±9

60x60 (24"x24") RETT.



±9

30x60 (12"x24") RETT.



FUGA 2 mm

brera | concrete and terracotta effect

bianco



beige

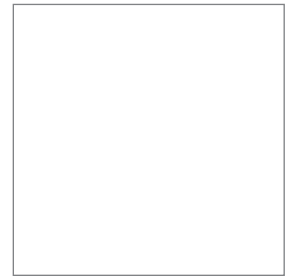

90x90 (36"x36") 92 ●
 8680059 bianco rett.
 8680049 beige rett.
 8680069 perla rett.
 8680079 grigio rett.

perla



grigio

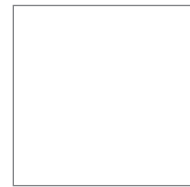
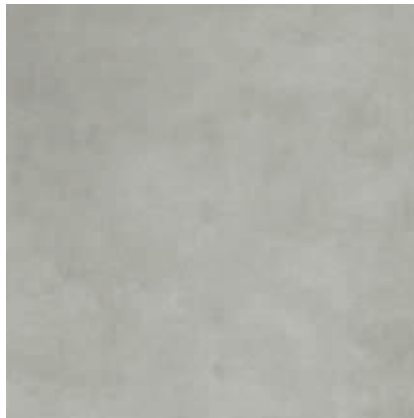

60x60 (24"x24") 78 ●
 8601080 bianco rett.
 8601070 beige rett.
 8601100 perla rett.
 8601090 grigio rett.



30x60 (12"x24") 78 ●
 8601081 bianco rett.
 8601071 beige rett.
 8601101 perla rett.
 8601091 grigio rett.

PEZZI SPECIALI trims - pieces speciales - formstücke - СОБИЕЭЛЕМЕНТЫ

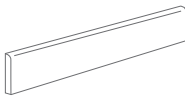

battiscopa rett.
 7,5x60 (3"x24")
 8601073 beige rett.
 8601083 bianco rett.
 8601093 grigio rett.
 8301103 perla rett.
 24 ▲ 14 ▢

IMBALLI packing - emballages - verpackung - УПАКОВКА

F.TO NOMINALE / NOMINAL SIZE	mm.	PCS / BOX	M2 / BOX	BOX / PLT	M2 / PLT	KG. / PLT
90x90 rett.	10	2	1,62	24	38,88	972
60x60 rett.	9	3	1,08	40	43,20	900
30x60 rett.	9	7	1,26	40	50,40	1120

brera

brera | concrete and terracotta effect

grigio rett. 90x90 (36"x36")

saime

113



concreta | concrete and terracotta effect

concreta

COLORI

colours - couleurs - farbe - ЦВЕТА

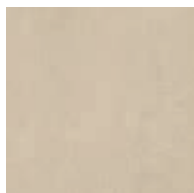

sabbia

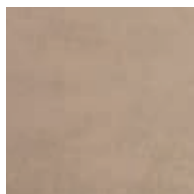

terra

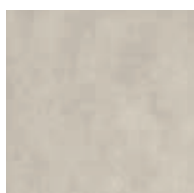

polvere

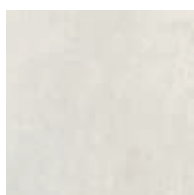

calce

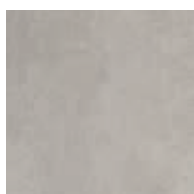

argilla

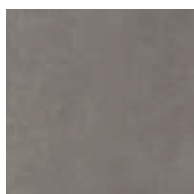

lava

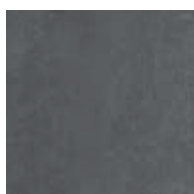

carbone

FORMATI

sizes - formats - format - ФОРМАТЫ

formati modulari

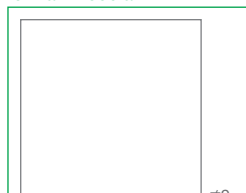

60x60 (24"x24") RETT. $\neq 9$

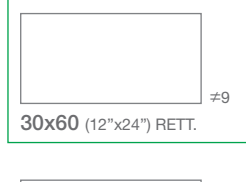

30x60 (12"x24") RETT. $\neq 9$

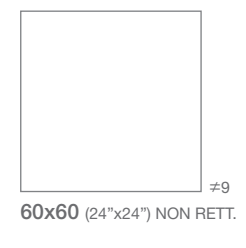

60x60 (24"x24") NON RETT. $\neq 9$

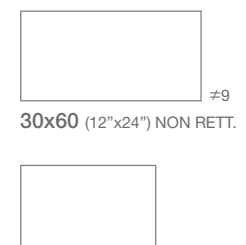

30x60 (12"x24") NON RETT. $\neq 9$



45x45 (18"x18") NON RETT. $\neq 9$



POSA 1/4



FUGA 2 mm
PER RETT.



FUGA >3 mm
PER NON RETT.

concreta | concrete and terracotta effect

sabbia



calce



60x60 (24"x24")

rett. 76 ●
 8600050 sabbia rett.
 8600060 terra rett.
 8600040 polvere rett.
 8600020 calce rett.
 8600010 argilla rett.
 8600030 lava rett.

terra



argilla



30x60 (12"x24")

rett. 76 ●
 8600051 sabbia rett.
 8600061 terra rett.
 8600041 polvere rett.
 8600021 calce rett.
 8600017 argilla rett.
 8600031 lava rett.

polvere



lava



60x60 (24"x24")

non rett. 69 ●
 8600955 sabbia
 7685445 terra
 7685475 polvere
 7685435 calce
 8600965 argilla
 7685465 lava

carbone



30x60 (12"x24")

non rett. 64 ●
 7675745 sabbia
 7675735 terra
 7675765 polvere
 7675725 calce
 7675775 argilla
 7675755 lava
 7679125 carbone



45x45 (18"x18")

non rett. 64 ●
 7652795 sabbia
 7652825 terra
 7652785 polvere
 7652805 calce
 7652815 argilla
 7652835 lava

mosaico 5x5 (2"x2") 124 ●

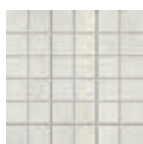

30x30 (12"x12")
7676975 calce

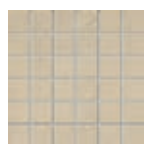

30x30 (12"x12")
7677005 sabbia



30x30 (12"x12")
7677015 terra

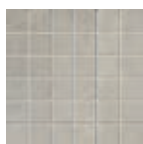

30x30 (12"x12")
7676965 argilla

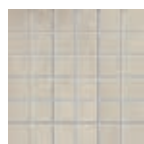

30x30 (12"x12")
7676995 polvere



30x30 (12"x12")
7676985 lava



30x30 (12"x12")
7676976 carbone

PEZZI SPECIALI trims - pieces speciales - formstücke - СОБИЕЭЛЕМЕНТЫ

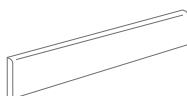







battiscopa rett.

7,5x60 (3"x24")

- 8600018 argilla rett.
- 8600023 calce rett.
- 8600033 lava rett.
- 8600043 polvere rett.
- 8600053 sabbia rett.
- 8600063 terra rett.

24 ▲ 14 ◻

IMBALLI packing - emballages - verpackung - УПАКОВКА

F.TO NOMINALE / NOMINAL SIZE	 mm.	 PCS / BOX	 M2 / BOX	 BOX / PLT	 M2 / PLT	 KG. / PLT
60,5x60,5 non rett.	9	3	1,10	40	44	900
60x60 rett.	9	3	1,08	40	43,20	900
30x60 rett./non rett.	9	7	1,26	40	50,4	989
45x45 non rett.	9	7	1,42	26	36,92	709
30x30 mosaico	9	11	1	30	30	570

cottoantico | concrete and terracotta effect



cottoantico

COLORI

colours - couleurs - farbe - ЦВЕТА



ocra



rosso



beige

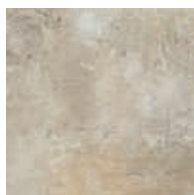

greige



bianco

FORMATI

sizes - formats - format - ФОРМАТЫ

naturale



30x60 (12"x24")



20x40 (8"x16")



20x20 (8"x8")

grip



30x60 (12"x24")



20x40 (8"x16")



20x20 (8"x8")

2 FINITURE

finishes - surfaces
Oberfläche - ПОВЕРХНОСТИ

Naturale

Grip

GS

V4



POSA 1/4



FUGA >3 mm



DIN 51130
R11 (GRIP)



DIN 51097
A+B+C (GRIP)

cottoantico | concrete and terracotta effect

bianco



naturale



30x60 (12"x24")
naturale 64 ●
7681481 bianco nat.
7681461 beige nat.
7681431 ocra nat.
7681441 rosso nat.
7681451 greige nat.

grip



30x60 (12"x24")
grip 64 ●
7692531 bianco grip
7692521 beige grip
7692561 ocra grip
7692571 rosso grip
7692541 greige grip

beige



20x40 (8"x16")
naturale 68 ●
7603081 bianco nat.
7603061 beige nat.
7603001 ocra nat.
7603021 rosso nat.
7603031 greige nat.



20x40 (8"x16")
grip 68 ●
7603551 beige grip
7603041 ocra grip
7603051 rosso grip
7603561 greige grip

greige



20x20 (8"x8")
naturale 68 ●
7603101 ocra nat.
7603111 rosso nat.



20x20 (8"x8")
grip 68 ●
7603131 ocra grip
7603141 rosso grip

ocra



rosso



mosaico nat. 5x5 (2"x2") 124 ●



30x30 (12"x12")
7692901 bianco

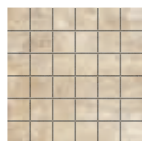

30x30 (12"x12")
7692881 beige



30x30 (12"x12")
7692871 greige

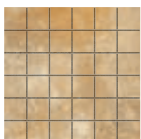

30x30 (12"x12")
7692851 ocra



30x30 (12"x12")
7692861 rosso

PEZZI SPECIALI trims - pieces speciales - formstücke - СОБЫЕЭЛЕМЕНТЫ

naturale

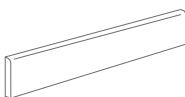

battiscopa naturale
7,5x60 (3"x24")
7681462 beige nat.
7681482 bianco nat.
7681452 greige nat.
7681432 ocra nat.
7681442 rosso nat.

24 ▲ 14 ◻

grip

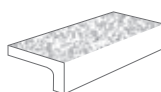

elemento elle pressa grip
15x30x3,5 (6"x12"x1,4")
7692523 beige grip
7692533 bianco grip
7692543 greige grip
7692563 ocra grip
7692573 rosso grip

44 ▲ 8 ◻

cottoantico | concrete and terracotta effect

IMBALLI packing - emballages - verpackung - УПАКОВКА

F.TO NOMINALE / NOMINAL SIZE	mm.	PCS / BOX	M2 / BOX	BOX / PLT	M2 / PLT	KG. / PLT
30x60	9	7	1,26	40	50,40	989
20x40	8,3	18	1,44	56	80,64	1330
20x20	8,3	30	1,20	68	81,60	1346
30x30 mosaico	9	11	1,00	-	-	-

cottocemento | concrete and terracotta effect



cottocemento

COLORI

colours - couleurs - farbe - ЦВЕТА



greige

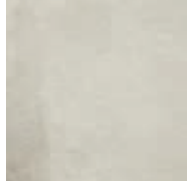

ghiaccio

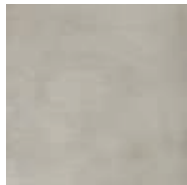

cenere

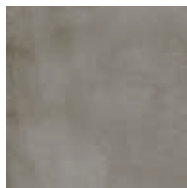

grigio

FORMATI

sizes - formats - format - ФОРМАТЫ

nat/sat

formati modulari



75,5x151,2 (30"x60") RETT.

≠10



75,5x75,5 (30"x30") RETT.

≠10

formati modulari



60x60 (24"x24") RETT.

≠9



30x60 (12"x24") RETT.

≠9



30x60 (12"x24") NON RETT.

≠9



45x45 (18"x18") NON RETT.

≠9

grip



45x45 (18"x18") NON RETT.

≠9

3 FINITURE

finishes - surfaces

Oberfläche - ПОВЕРХНОСТИ

Naturale

Satinato

Grip



FUGA 2 mm
PER RETT.



FUGA >3 mm
PER NON RETT.



DIN 51130
R11 (GRIP)



DIN 51097
A+B+C (GRIP)

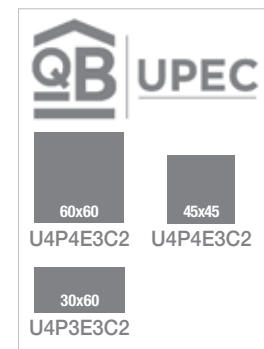

cottocemento | concrete and terracotta effect

greige



mosaico 5x5 (2"x2") 124 ●



30x30 (12"x12")
7679855 nat.

nat/sat

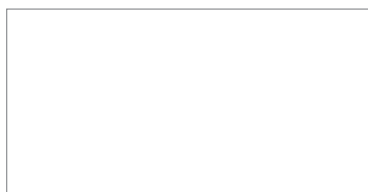

75,5x151,2 (30"x60")
rett.
7690319 nat. rett. 100 ●



75,5x75,5 (30"x30")
rett.
7690039 nat. rett. 85 ●



60x60 (24"x24")
rett.
8600410 nat. rett. 78 ●
8600450 sat. rett. 88 ●



30x60 (12"x24")
rett.
8600413 nat. rett. 78 ●
8600451 sat. rett. 88 ●



30x60 (12"x24")
non rett.
7679185 nat. 68 ●



45x45 (18"x18")
non rett.
7665085 nat. 64 ●

grip



45x45 (18"x18")
non rett.
7666525 grip 64 ●

ghiaccio



mosaico 5x5 (2"x2") 124 ●

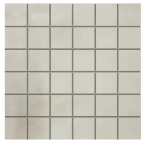

30x30 (12"x12")
7679865 nat.

mosaico mix 2,2x2,2 (0,87"x0,87") 144 ●

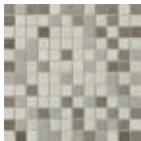

30x30 (12"x12")
7687965 mosaico cen/ghi/gri mix

nat/sat



75,5x151,2 (30"x60")
rett.
7690309 nat. rett. 100 ●



75,5x75,5 (30"x30")
rett.
7690029 nat. rett. 85 ●



60x60 (24"x24")
rett.
8600400 nat. rett. 78 ●
8600440 sat. rett. 88 ●



30x60 (12"x24")
rett.
8600401 nat. rett. 78 ●
8600441 sat. rett. 88 ●



30x60 (12"x24")
non rett.
7679175 nat. 68 ●



45x45 (18"x18")
non rett.
7665095 nat. 64 ●

grip



45x45 (18"x18")
non rett.
7666635 grip 64 ●

cottocemento

cottocemento | concrete and terracotta effect

cenere



mosaico 5x5 (2"x2") 124 ●



30x30 (12"x12")
7679875 nat.

mosaico mix 2,2x2,2 (0,87"x0,87") 144 ●



30x30 (12"x12")
7687965 mosaico cen/ghi/gri mix

nat/sat



75,5x151,2 (30"x60")
rett.
7690299 nat. rett. 100 ●



75,5x75,5 (30"x30")
rett.
7690019 nat. rett. 85 ●



60x60 (24"x24")
rett.
8600390 nat. rett. 78 ●
8600430 sat. rett. 88 ●



30x60 (12"x24")
rett.
8600391 nat. rett. 78 ●
8600431 sat. rett. 88 ●



30x60 (12"x24")
non rett.
7679165 nat. 68 ●



45x45 (18"x18")
non rett.
7666005 nat. 64 ●

grip



45x45 (18"x18")
non rett.
7666535 grip 64 ●

grigio



mosaico 5x5 (2"x2") 124 ●



30x30 (12"x12")
7679885 nat.

mosaico mix 2,2x2,2 (0,87"x0,87") 144 ●



30x30 (12"x12")
7687965 mosaico cen/ghi/gri mix

nat/sat

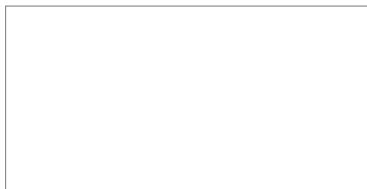

75,5x151,2 (30"x60")
rett.
7690289 nat. rett. 100 ●



75,5x75,5 (30"x30")
rett.
7690009 nat. rett. 85 ●



60x60 (24"x24")
rett.
8600420 nat. rett. 78 ●
8600460 sat. rett. 88 ●



30x60 (12"x24")
rett.
8600421 nat. rett. 78 ●
8600461 sat. rett. 88 ●



30x60 (12"x24")
non rett.
7679195 nat. 68 ●



45x45 (18"x18")
non rett.
7666015 nat. 64 ●

grip



45x45 (18"x18")
non rett.
7666625 grip 64 ●

cottocemento

cottocemento | concrete and terracotta effect

PEZZI SPECIALI trims - pieces speciales - formstücke - СОБИЕЭЛЕМЕНТЫ

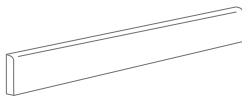

battiscopa rett.

7,5x60 (3"x24")

8600414 greige nat. rett.
8600403 ghiaccio nat. rett.
8600393 cenere nat. rett.
8600423 grigio nat. rett.

24 ▲ 14 ◻



*

gradone CR rett.

33,3x60 (13"x24")

7687716 greige nat. rett.
7687836 ghiaccio nat. rett.
7687846 cenere nat. rett.
7687856 grigio nat. rett.

113 ▲ 4 ◻



* angolare CR SX rett.

33,3x60 (13"x24")

7687718 greige nat. rett.
7687838 ghiaccio nat. rett.
7687848 cenere nat. rett.
7687858 grigio nat. rett.

123 ▲ 2 ◻

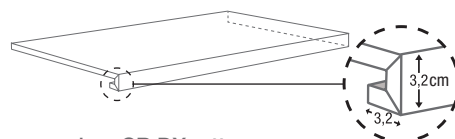

* angolare CR DX rett.

33,3x60 (13"x24")

7687717 greige nat. rett.
7687837 ghiaccio nat. rett.
7687847 cenere nat. rett.
7687857 grigio nat. rett.

123 ▲ 2 ◻

cotto cemento | concrete and terracotta effect

IMBALLI packing - emballages - verpackung - УПАКОВКА

F.TO NOMINALE / NOMINAL SIZE	mm.	PCS / BOX	M2 / BOX	BOX / PLT	M2 / PLT	KG. / PLT
75,5x151,2 rett.	10	2	2,28	22	50,16	1153,68
75,5x75,5 rett.	10	2	1,14	42	47,88	1138,2
60x60 rett.	9	3	1,08	40	43,20	900
30x60 rett./non rett.	9	7	1,26	40	50,40	989
45x45 non rett./grip	9	7	1,42	26	36,92	707,2
30x30 mosaico	9	11	1	-	-	-

cottocemento

cottocemento | concrete and terracotta effect

ghiaccio rett. 75,5x75,5 (30"x30")

saime

129

ferrocemento | concrete and terracotta effect

ferrocemento

TILE+

COLORI

colours - couleurs
farbe - ЦВЕТА



bianco

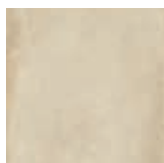

beige



fango

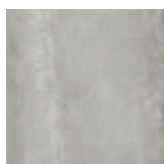

grigio

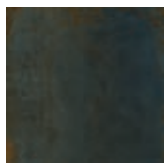

nero

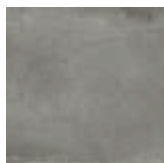

antracite

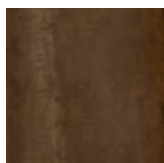

rame

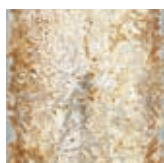

lamiera

FORMATI TILE+

sizes - formats
format - ФОРМАТЫ

nat

formati modulari



120x260 (47"x102") RETT. $\neq 6,5$



120x240 (47"x95") RETT. $\neq 6,5$



120x120 (47"x47") RETT. $\neq 6,5$

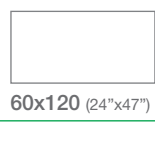

60x120 (24"x47") RETT. $\neq 6,5$

nat/lapp

formati modulari

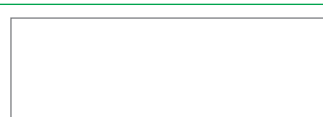

90x270 (36"x106") RETT. $\neq 6$
only: bianco - grigio - beige - nero



90x90 (36"x36") RETT. $\neq 6$
only: bianco - grigio - beige - nero



45x90 (18"x36") RETT. $\neq 6$
only: bianco - grigio - beige - nero

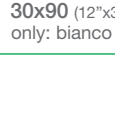

30x90 (12"x36") RETT. $\neq 6$
only: bianco - grigio - beige - nero

FORMATI standard

sizes - formats
format - ФОРМАТЫ

nat/lapp

formati modulari



60x120 (24"x47") RETT. $\neq 9$



30x120 (12"x47") RETT. $\neq 9$



60x60 (24"x24") RETT. $\neq 9$



30x60 (12"x24") RETT. $\neq 9$



30x60 (12"x24") NON RETT. $\neq 9$

29,7x59,5 (12"x24") RETT. $\neq 9$



90x180 (36"x71") RETT. $\neq 10$
only: bianco - grigio

grip



60x60 (24"x24") RETT. $\neq 9$

only: beige - grigio - antracite



30x60 (12"x24") NON RETT. $\neq 9$

3 FINITURE

finishes - surfaces
Oberfläche - ПОВЕРХНОСТИ

Naturale

Lappato

Grip



POSA 1/4



FUGA 2 mm
PER RETT.



FUGA >3 mm
PER NON RETT.



DIN 51130
R11 (GRIP)



DIN 51097
A+B+C (GRIP)



ferrocemento | concrete and terracotta effect

bianco

ferrocemento
TILE+

120x260 (47"x102")
T600395 nat. rett. 114 ●



120x240 (47"x95")
T611015 nat. rett. 112 ●



120x120 (47"x47")
T610985 nat. rett. 104 ●



60x120 (24"x47")
T611045 nat. rett. 104 ●



90x270 (36"x106")
T622245 nat. rett. 107 ●
T622285 lapp. rett. 114 ●



90x90 (36"x36")
T621825 nat. rett. 94 ●
T622295 lapp. rett. 108 ●



45x90 (18"x36")
T621865 nat. rett. 94 ●
T622335 lapp. rett. 108 ●



30x90 (12"x36")
T621925 nat. rett. 94 ●
T622375 lapp. rett. 108 ●

ferrocemento
standard

60x120 (24"x47")
8600781 nat. rett. 86 ●
8600171 lapp. rett. 96 ●



30x120 (12"x47")
8600783 nat. rett. 86 ●
8600173 lapp. rett. 96 ●



60x60 (24"x24")
8600780 nat. rett. 78 ●
8600170 lapp. rett. 88 ●



30x60 (12"x24")
8600782 nat. rett. 78 ●
8600172 lapp. rett. 88 ●



30x60 (12"x24")
7692015 nat. 68 ●
29,7x59,5 (12"x24")
7692065 nat. rett. 78 ●
7693145 lapp. rett. 86 ●



90x180 (36"x71")
8680597 nat. rett. 103 ●

mosaico 5x5 (2"x2") 124 ●



30x30 (12"x12")
7692645 nat.
7693215 lapp.

listellato 131 ●



30x60 (12"x24")
7692695 nat.
7693165 lapp.

grip



30x60 (12"x24")
7697085 grip 68 ●

grigio



ferrocemento TILE+



120x260 (47"x102")
T600415 nat. rett. 114 ●

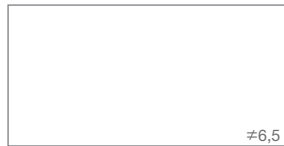

120x240 (47"x95")
T611035 nat. rett. 112 ●



120x120 (47"x47")
T611005 nat. rett. 104 ●



60x120 (24"x47")
T611065 nat. rett. 104 ●



90x270 (36"x106")
T622215 nat. rett. 107 ●
T622255 lapp. rett. 114 ●



90x90 (36"x36")
T621835 nat. rett. 94 ●
T622315 lapp. rett. 108 ●



45x90 (18"x36")
T621875 nat. rett. 94 ●
T622355 lapp. rett. 108 ●



30x90 (12"x36")
T621935 nat. rett. 94 ●
T622395 lapp. rett. 108 ●

ferrocemento standard



60x120 (24"x47")
8600801 nat. rett. 86 ●
8600191 lapp. rett. 96 ●



30x120 (12"x47")
8600803 nat. rett. 86 ●
8600193 lapp. rett. 96 ●



60x60 (24"x24")
8600800 nat. rett. 78 ●
8600190 lapp. rett. 88 ●



30x60 (12"x24")
8600802 nat. rett. 78 ●
8600192 lapp. rett. 88 ●



30x60 (12"x24")
7681475 nat. 68 ●



29,7x59,5 (12"x24")
7692045 nat. rett. 78 ●
7693125 lapp. rett. 86 ●

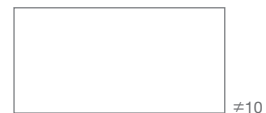

90x180 (36"x71")
8680618 nat. rett. 91 ●

mosaico 5x5 (2"x2") 124 ●



30x30 (12"x12")
7692625 nat.
7693225 lapp.

listellato 131 ●



30x60 (12"x24")
7692675 nat.
7693175 lapp.

grip



60x60 (24"x24")
8600870 grip rett. 78 ●



30x60 (12"x24")
7697065 grip 68 ●

ferrocemento | concrete and terracotta effect

beige

ferrocemento
TILE+

120x260 (47"x102")
T600405 nat. rett. 114 ●



120x240 (47"x95")
T611025 nat. rett. 112 ●



120x120 (47"x47")
T610995 nat. rett. 104 ●



60x120 (24"x47")
T611055 nat. rett. 104 ●



90x270 (36"x106")
T622225 nat. rett. 107 ●
T622265 lapp. rett. 114 ●



90x90 (36"x36")
T621845 nat. rett. 94 ●
T622305 lapp. rett. 108 ●



45x90 (18"x36")
T621905 nat. rett. 94 ●
T622345 lapp. rett. 108 ●



30x90 (12"x36")
T621945 nat. rett. 94 ●
T622385 lapp. rett. 108 ●

ferrocemento
standard

60x120 (24"x47")
8600791 nat. rett. 86 ●
8600161 lapp. rett. 96 ●



30x120 (12"x47")
8600793 nat. rett. 86 ●
8600163 lapp. rett. 96 ●



60x60 (24"x24")
8600790 nat. rett. 78 ●
8600160 lapp. rett. 88 ●



30x60 (12"x24")
8600792 nat. rett. 78 ●
8600162 lapp. rett. 88 ●



30x60 (12"x24")
7692005 nat. 68 ●
29,7x59,5 (12"x24")
7692055 nat. rett. 78 ●
7693135 lapp. rett. 86 ●

mosaico 5x5 (2"x2") 124 ●



30x30 (12"x12")
7692635 nat.
7693205 lapp.

listellato 131 ●



30x60 (12"x24")
7692685 nat.
7693155 lapp.

grip



60x60 (24"x24")
8600860 grip rett. 78 ●



30x60 (12"x24")
7697075 grip 68 ●

nero

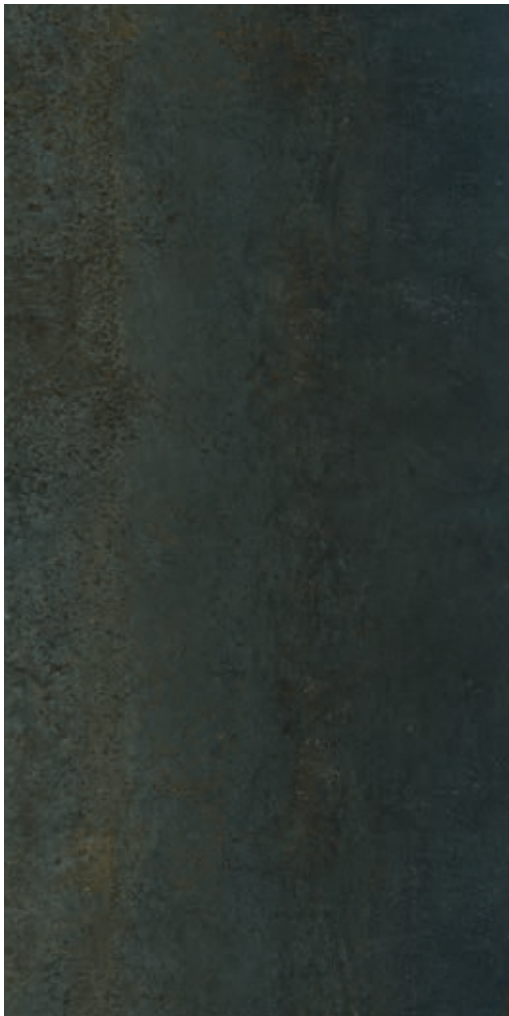

**ferrocemento
TILE+**



120x260 (47"x102")
T600355 nat. rett. 114 ●



120x240 (47"x95")
T610905 nat. rett. 112 ●



120x120 (47"x47")
T610885 nat. rett. 104 ●



60x120 (24"x47")
T610925 nat. rett. 104 ●



90x270 (36"x106")
T622235 nat. rett. 107 ●
T622275 lapp. rett. 114 ●



90x90 (36"x36")
T621855 nat. rett. 94 ●
T622325 lapp. rett. 108 ●



45x90 (18"x36")
T621915 nat. rett. 94 ●
T622365 lapp. rett. 108 ●



30x90 (12"x36")
T621955 nat. rett. 94 ●
T622405 lapp. rett. 108 ●

**ferrocemento
standard**



60x120 (24"x47")
8600811 nat. rett. 86 ●
8600201 lapp. rett. 96 ●



30x120 (12"x47")
8600813 nat. rett. 86 ●
8600203 lapp. rett. 96 ●



60x60 (24"x24")
8600810 nat. rett. 78 ●
8600200 lapp. rett. 88 ●



30x60 (12"x24")
8600812 nat. rett. 78 ●
8600202 lapp. rett. 88 ●



30x60 (12"x24")
7681455 nat. 68 ●
29,7x59,5 (12"x24")
7692025 nat. rett. 78 ●
7693105 lapp. rett. 86 ●

mosaico 5x5 (2"x2") 124 ●



30x30 (12"x12")
7692605 nat.
7693235 lapp.

listellato 131 ●



30x60 (12"x24")
7692655 nat.
7693185 lapp.

grip



30x60 (12"x24")
7697045 grip 68 ●

ferrocemento | concrete and terracotta effect

fango

ferrocemento
TILE+

120x260 (47"x102")
T601645 nat. rett. 114 ●



120x120 (47"x47")
T601675 nat. rett. 104 ●



60x120 (24"x47")
T601695 nat. rett. 104 ●

ferrocemento
standard

60x120 (24"x47")
8600831 nat. rett. 86 ●
8600181 lapp. rett. 96 ●



30x120 (12"x47")
8600833 nat. rett. 86 ●
8600183 lapp. rett. 96 ●



60x60 (24"x24")
8600830 nat. rett. 78 ●
8600180 lapp. rett. 88 ●



30x60 (12"x24")
8600832 nat. rett. 78 ●
8600182 lapp. rett. 88 ●



30x60 (12"x24")
7693265 nat. 68 ●

29,7x59,5 (12"x24")
7693285 nat. rett. 78 ●
7693305 lapp. rett. 86 ●

mosaico 5x5 (2"x2") 124 ●



30x30 (12"x12")
7693325 nat.
7693565 lapp.

listellato 131 ●



30x60 (12"x24")
7693345 nat.
7693555 lapp.

grip



30x60 (12"x24")
7697105 grip 68 ●

antracite



ferrocemento TILE+

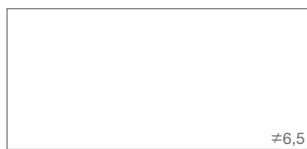

120x260 (47"x102")
T601665 nat. rett. 114 ●



120x120 (47"x47")
T601685 nat. rett. 104 ●



60x120 (24"x47")
T601705 nat. rett. 104 ●

ferrocemento standard



60x120 (24"x47")
8600841 nat. rett. 86 ●
8600151 lapp. rett. 96 ●



30x120 (12"x47")
8600843 nat. rett. 86 ●
8600153 lapp. rett. 96 ●



60x60 (24"x24")
8600840 nat. rett. 78 ●
8600150 lapp. rett. 88 ●



30x60 (12"x24")
8600842 nat. rett. 78 ●
8600152 lapp. rett. 88 ●



30x60 (12"x24")
7693255 nat. 68 ●

29,7x59,5 (12"x24")
7693275 nat. rett. 78 ●
7693295 lapp. rett. 86 ●

mosaico 5x5 (2"x2") 124 ●



30x30 (12"x12")
7693315 nat.
7693545 lapp.

listellato 131 ●



30x60 (12"x24")
7693335 nat.
7693535 lapp.

grip



60x60 (24"x24")
8600850 grip rett. 78 ●



30x60 (12"x24")
7697095 grip 68 ●

ferrocemento | concrete and terracotta effect

rame



ferrocemento TILE+



120x260 (47"x102")
T600345 nat. rett. 114 ●



120x240 (47"x95")
T610895 nat. rett. 112 ●



120x120 (47"x47")
T610875 nat. rett. 104 ●



60x120 (24"x47")
T610915 nat. rett. 104 ●

ferrocemento standard



60x120 (24"x47")
8600821 nat. rett. 86 ●
8600211 lapp. rett. 96 ●



30x120 (12"x47")
8600823 nat. rett. 86 ●
8600213 lapp. rett. 96 ●



60x60 (24"x24")
8600820 nat. rett. 78 ●
8600210 lapp. rett. 88 ●



30x60 (12"x24")
8600822 nat. rett. 78 ●
8600212 lapp. rett. 88 ●



30x60 (12"x24")
7681465 nat. 68 ●
29,7x59,5 (12"x24")
7692035 nat. rett. 78 ●
7693115 lapp. rett. 86 ●

mosaico 5x5 (2"x2") 124 ●



30x30 (12"x12")
7692615 nat.
7693245 lapp.

listellato 131 ●



30x60 (12"x24")
7692665 nat.
7693195 lapp.

grip



30x60 (12"x24")
7697055 grip 68 ●

lamiera



ferrocemento TILE+



120x240 (47"x95")
T613155 nat. rett. 118 ●



120x120 (47"x47")
T813156 nat. rett. 108 ●

ferrocemento standard



60x120 (24"x47")
8600851 nat. rett. 91 ●

ferrocemento | concrete and terracotta effect

ferrocemento
TILE+ #6



battiscopa 7,5x90 (3"x36")
nat rett.
T621906 beige nat. rett.
T621866 bianco nat. rett.
T621876 grigio nat. rett.
T621916 nero nat. rett.
40 ▲ 5 ◻

ferrocemento
standard #9



battiscopa non rett.
7,5x60 (3"x24")
7693515 antracite nat.
7692006 beige nat.
7692016 bianco nat.
7693525 fango nat.
7681476 grigio nat.
7681456 nero nat.
7681466 rame nat.
24 ▲ 14 ◻

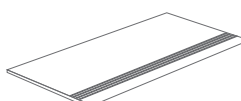

gradino step non rett.
30x60 (12"x24")
7693395 antracite nat.
7692007 beige nat.
7692017 bianco nat.
7693405 fango nat.
7681477 grigio nat.
7681457 nero nat.
7681467 rame nat.
48 ▲ 7 ◻

battiscopa rett.
7,5x60 (3"x24")
8600839 antracite nat. rett.
8600789 beige nat. rett.
8600779 bianco nat. rett.
8600829 fango nat. rett.
8600799 grigio nat. rett.
8600809 nero nat. rett.
8600819 rame nat. rett.
8651119 lamiera nat. rett.
24 ▲ 14 ◻

gradino step rett.
30x60 (12"x24")
8600844 antracite nat. rett.
8600794 beige nat. rett.
8600784 bianco nat. rett.
8600834 fango nat. rett.
8600804 grigio nat. rett.
8600814 nero nat. rett.
8600824 rame nat. rett.
48 ▲ 7 ◻

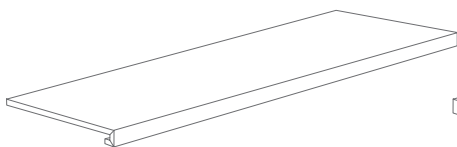

* gradone CR rett.
33,3x120 (13"x47")
7693455 antracite nat. rett.
7649377 beige nat. rett.
7649387 bianco nat. rett.
7693465 fango nat. rett.
7649367 grigio nat. rett.
7649337 nero nat. rett.
7649347 rame nat. rett.
141 ▲ 2 ◻

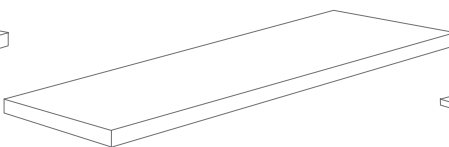

* angolare CR SX rett.
33,3x120 (13"x47")
7693445 antracite nat. rett.
7649379 beige nat. rett.
7649389 bianco nat. rett.
7693445 fango nat. rett.
7649369 grigio nat. rett.
7649339 nero nat. rett.
7649349 rame nat. rett.
148 ▲ 2 ◻

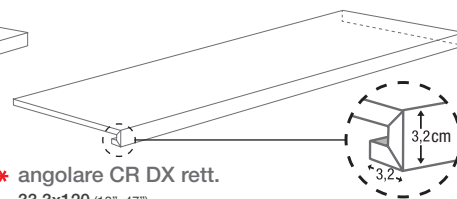







* angolare CR DX rett.
33,3x120 (13"x47")
7693425 antracite nat. rett.
7649378 beige nat. rett.
7649388 bianco nat. rett.
7693425 fango nat. rett.
7649368 grigio nat. rett.
7649338 nero nat. rett.
7649348 rame nat. rett.
148 ▲ 2 ◻

ferrocemento | concrete and terracotta effect

IMBALLI packing - emballages - verpackung - УПАКОВКА

TILE+		mm.	TIPOLOGIA IMBALLO / PACKAGING		LASTRA / SLAB			CASSA - CAVALLETTO / CRATE - A-FRAME			
F.TO NOMINALE / NOMINAL SIZE			ARTICOLO / ITEM	DIMENSIONE / SIZE	PCS	M2	KG	PCS	M2	KG VUOTO/EMPTY	KG TOT
120x260	rett.	6,5	* cassa / crate	136x284x38h	1	3,12	49,92	20	62,40	95	1093
120x240	rett.	6,5		136x264x38h	1	2,88	46,08	20	57,60	90	1011
90x270	rett.	6		106x296x20h	1	2,43	38	22	53,46	97	933
90x90	rett.	6	pallet con sponda	94x124	3	2,43	12,66	78	63,10	14	1001,5
45x90	rett.	6		94x124	5	2,025	6,08	150	60,75	14	926
30x90	rett.	6		100x120	6	1,62	4,15	180	48,60	14	761

TILE+		mm.	TIPOLOGIA IMBALLO / PACKAGING						
F.TO NOMINALE / NOMINAL SIZE			ARTICOLO / ITEM	DIMENSIONE / SIZE	PCS / BOX	M2 / BOX	BOX / PLT	M2 / PLT	KG. / PLT
120x120	rett.	6,5	pallet con sponda	123x143	2	2,88	24	69,12	1106
60x120	rett.	6,5	pallet	95x122	3	2,16	36	77,76	1244

STANDARD		mm.					
F.TO NOMINALE / NOMINAL SIZE			PCS / BOX	M2 / BOX	BOX / PLT	M2 / PLT	KG. / PLT
90x180	rett.	10	1	1,62	30	48,60	1215
60x120	rett.	9	2	1,44	36	51,84	1152
30x120	rett.	9	3	1,08	45	48,60	1080
60x60	rett.	9	3	1,08	40	43,20	900
30x60	rett.	9	7	1,26	40	50,40	1120
29,7x59,5	rett.	9	7	1,24	40	49,60	1000
30x30	mosaico	9	11	1	-	-	-
30x60	listellato	9	4	0,72	-	-	-

* Per casse complete con un unico articolo la cassa viene fornita gratuita. Per vendite inferiori alla cassa completa la cassa viene addebitata al costo di € 70,00

If a crate is complete and contains one single item the crate is supplied free of charge. If a crate is not complete the crate is charged at a cost of €70.00

Bei kompletten Kisten, die einen einzigen Artikel enthalten, wird die Kiste nicht berechnet. Bei Verkäufen nicht kompletter Kisten werden die Kisten zum Preis von € 70,00 berechnet.

Pour des caisses remplies avec un seul article, celles-ci seront fournies gratuitement. Pour des ventes qui ne remplissent pas la caisse, celle-ci est vendue à un prix de 70,00 €

Ящики, заполненные полностью одним артикулом, поставляются бесплатно. При продаже количества меньше одного полного ящика взимается плата в размере 70,00 € за ящик

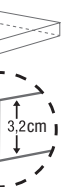

global | concrete and terracotta effect



COLORI

colours - couleurs
farbe - ЦВЕТА

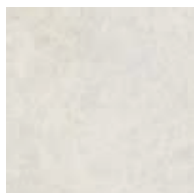

white

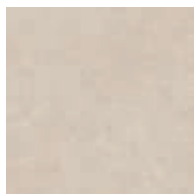

cream

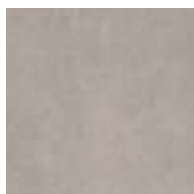

taupe

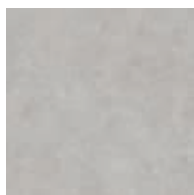

silver

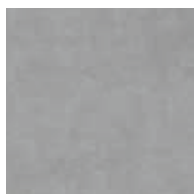

grey



smoke

FORMATI TILE+

sizes - formats
format - ФОРМАТЫ

formati modulari

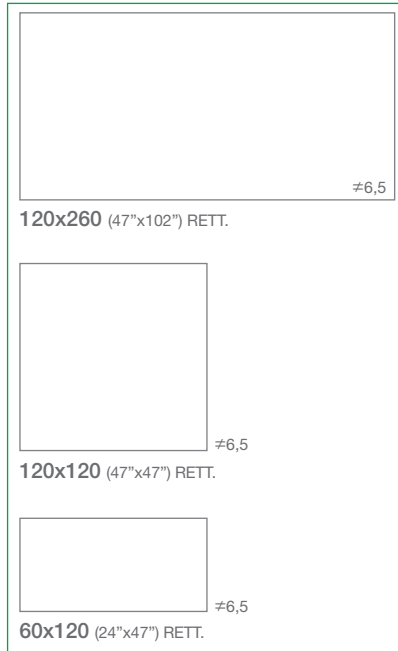

FORMATI standard

sizes - formats
format - ФОРМАТЫ

formati modulari

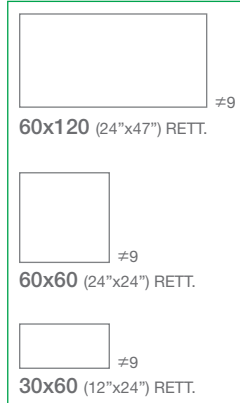

2 FINITURE

finishes - surfaces
Oberfläche - ПОВЕРХНОСТИ

Naturale

Grip



POSA 1/4



FUGA 2 mm



DIN 51130
R11 (GRIP)



DIN 51097
A+B+C (GRIP)



global | concrete and terracotta effect

white



global TILE+



120x260 (47"x102")
T800205 rett.

114 ●

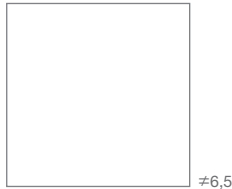

120x120 (47"x47")
T610675 rett.

104 ●



60x120 (24"x47")
T610735 rett.

104 ●

global standard



60x120 (24"x47")

8601161 rett. 86 ●



60x60 (24"x24")

8601160 rett. 78 ●



30x60 (12"x24")

8601162 rett. 78 ●

mosaico 5x5 (2"x2") 124 ●



30x30 (12"x12")
7693095

silver



global TILE+



120x260 (47"x102")
T800215 rett.

114 ●



120x120 (47"x47")
T610685 rett.

104 ●



60x120 (24"x47")
T610745 rett.

104 ●

global standard



60x120 (24"x47")
8601131 rett.

86 ●



60x60 (24"x24")
8601130 rett.

78 ●



30x60 (12"x24")
860132 rett.

78 ●

mosaico 5x5 (2"x2") 124 ●



30x30 (12"x12")
7693065

global | concrete and terracotta effect

grey



global TILE+



120x260 (47"x102")
T800255 rett.

114 ●



120x120 (47"x47")
T610725 rett.

104 ●



60x120 (24"x47")
T610785 rett.

104 ●

global standard



60x120 (24"x47")

8601121 rett. 86 ●



60x60 (24"x24")

8601120 rett. 78 ●



30x60 (12"x24")

8601122 rett. 78 ●

mosaico 5x5 (2"x2") 124 ●



30x30 (12"x12")
7693055

smoke



global TILE+



120x260 (47"x102")
T800245 rett.

114 ●

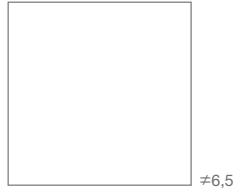

120x120 (47"x47")
T610715 rett.

104 ●



60x120 (24"x47")
T610775 rett.

104 ●

global standard



60x120 (24"x47")
8601141 rett.

86 ●



60x60 (24"x24")
8601140 rett.

78 ●



30x60 (12"x24")
8601142 rett.

78 ●

mosaico 5x5 (2"x2") 124 ●



30x30 (12"x12")
7693075

global | concrete and terracotta effect

cream

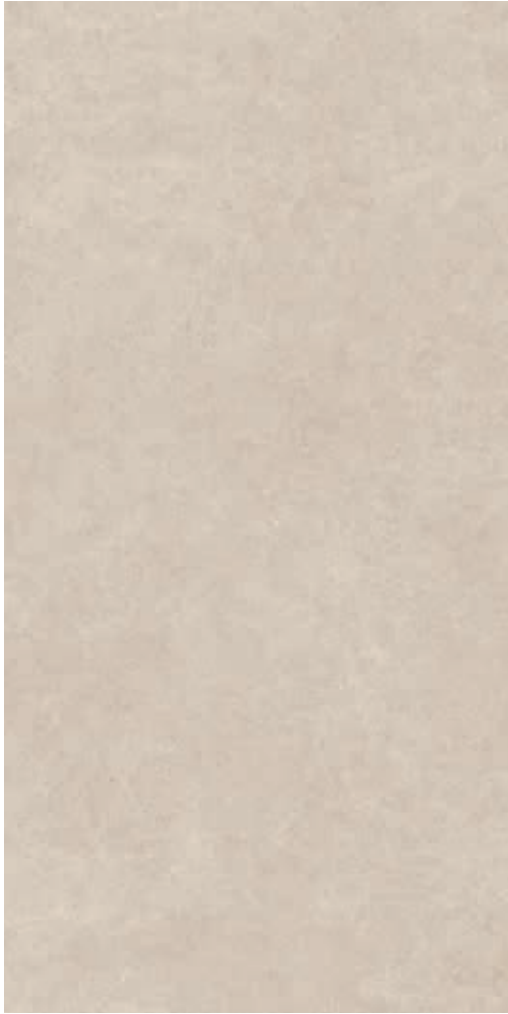

global TILE+



120x260 (47"x102")
T800235 rett.

114 ●

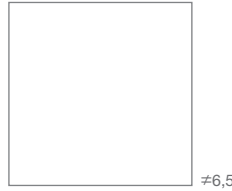

120x120 (47"x47")
T610705 rett.

104 ●



60x120 (24"x47")
T610765 rett.

104 ●

global standard



60x120 (24"x47")

8601111 rett. 86 ●



60x60 (24"x24")

8601110 rett. 78 ●



30x60 (12"x24")

8601112 rett. 78 ●

mosaico 5x5 (2"x2") 124 ●



30x30 (12"x12")
7693045

taupe



global TILE+



120x260 (47"x102")
T800225 rett.

114 ●



120x120 (47"x47")
T610695 rett.

104 ●



60x120 (24"x47")
T610755 rett.

104 ●

global standard



60x120 (24"x47")
8601151 rett.

86 ●



60x60 (24"x24")
8601150 rett.

78 ●



30x60 (12"x24")
8601152 rett.

78 ●

mosaico 5x5 (2"x2") 124 ●



30x30 (12"x12")
7693085

global | concrete and terracotta effect

PEZZI SPECIALI trims - pieces speciales - formstücke - СОБИЕЭЛЕМЕНТЫ

standard

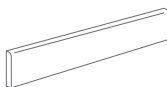

battiscopa rett. #9
7,5x60 (3"x24")
8601109 cream rett.
8601119 grey rett.
8601129 silver rett.
8601139 smoke rett.
8601149 taupe rett.
8601159 white rett.

24 ▲ 14 ☐

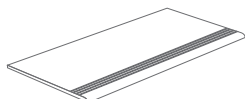



gradino step rett. #9
30x60 (12"x24")
8601114 cream rett.
8601124 grey rett.
8601134 silver rett.
8601144 smoke rett.
8601154 taupe rett.
8601164 white rett.





48 ▲ 7 ☐

global | concrete and terracotta effect

IMBALLI packing - emballages - verpackung - УПАКОВКА

TILE+ F.TO NOMINALE / NOMINAL SIZE	mm.	TIPOLOGIA IMBALLO / PACKAGING		LASTRA / SLAB			CASSA / CRATE			
		ARTICOLO / ITEM	DIMENSIONE / SIZE	PCS	M2	KG	PCS	M2	KG VUOTO/EMPTY	KG TOT
120x260 rett.	6,5	*cassa / crate 	136x284x38h	1	3,12	49,92	20	62,40	95	1093

TILE+ F.TO NOMINALE / NOMINAL SIZE	mm.	TIPOLOGIA IMBALLO / PACKAGING						
		ARTICOLO / ITEM	DIMENSIONE / SIZE	PCS / BOX	M2 / BOX	BOX / PLT	M2 / PLT	KG. / PLT
120x120 rett.	6,5	pallet con sponda	123x143	2	2,88	24	69,12	1105
60x120 rett.	6,5	pallet	95x122	3	2,16	36	77,76	1244

STANDARD F.TO NOMINALE / NOMINAL SIZE	mm.	 PCS / BOX	 M2 / BOX	 BOX / PLT	 M2 / PLT	 KG. / PLT
60x120 rett.	9	2	1,44	36	51,84	1170
60x60 rett.	9	3	1,08	40	43,20	900
30x60 rett.	9	7	1,26	40	50,40	1120
30x30 mosaico	9	11	1	-	-	-

* Per casse complete con un unico articolo la cassa viene fornita gratuita. Per vendite inferiori alla cassa completa la cassa viene addebitata al costo di € 70,00

If a crate is complete and contains one single item the crate is supplied free of charge. If a crate is not complete the crate is charged at a cost of €70,00

Bei kompletten Kisten, die einen einzigen Artikel enthalten, wird die Kiste nicht berechnet. Bei Verkäufen nicht kompletter Kisten werden die Kisten zum Preis von € 70,00 berechnet.

Pour des caisses remplies avec un seul article, celles-ci seront fournies gratuitement. Pour des ventes qui ne remplissent pas la caisse, celle-ci est vendue à un prix de 70,00 €

З Ящики, заполненные полностью одним артикулом, поставляются бесплатно. При продаже количества меньше одного полного ящика взимается плата в размере 70,00 € за ящик

global
TILE+

global | concrete and terracotta effect

wall: cream rett. 120x240 (47"x95")
desk: taupe rett. 120x120 (47"x47")
floor: cream rett. 120x240 (47"x95")

saime

icon | concrete and terracotta effect



COLORI

colours - couleurs
farbe - ЦВЕТА

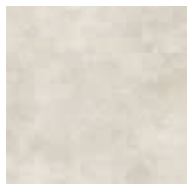

white

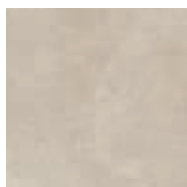

almond

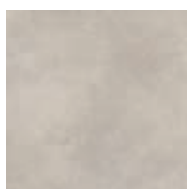

artic

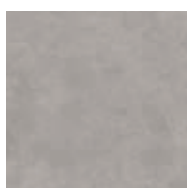

ash

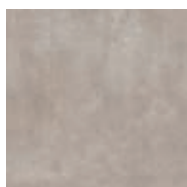

taupe

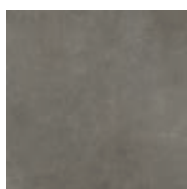

grey

FORMATI TILE+

sizes - formats
format - ФОРМАТЫ

matt/sat

formati modulari

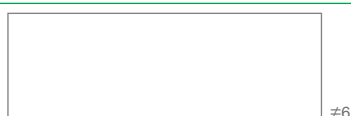

90x270 (36"x106") RETT. #6



90x90 (36"x36") RETT. #6



45x90 (18"x36") RETT. #6



30x90 (12"x36") RETT. #6

FORMATI standard

sizes - formats
format - ФОРМАТЫ

nat/sat

formati modulari



60x120 (24"x47") RETT. #9



60x60 (24"x24") RETT. #9



30x60 (12"x24") RETT. #9

nat



30x60 (12"x24") NON RETT. #9

30x60 (12"x24") RETT. #9

3 FINITURE

finishes - surfaces
Oberfläche - ПОВЕРХНОСТИ

Naturale

Matt

Satinato

> pag. 162

roc #9

30x60 (12"x24") NON RETT.

> pag. 252

grip 2CM

#20

60x120 (24"x47") RETT.

ONLY: Almond - Ash - Artic

grip 2CM

#20

60x60 (24"x24") RETT.

ONLY: Almond - Ash - Artic

GM

V2



POSA 1/4



FUGA 2 mm
PER RETT.



FUGA >3 mm
PER NON RETT.

icon | concrete and terracotta effect

white

icon | concrete and terracotta effect



icon TILE+



90x270 (36"x106")
T621675 matt rett. 107 ●
T621735 sat. rett. 107 ●



90x90 (36"x36")
T621315 matt rett. 94 ●
T621375 sat. rett. 94 ●



45x90 (18"x36")
T621425 matt rett. 94 ●
T621495 sat. rett. 94 ●



30x90 (12"x36")
T621555 matt rett. 94 ●
T621615 sat. rett. 94 ●

icon standard



60x120 (24"x47")
8600525 nat. rett. 86 ●
8600765 sat. rett. 86 ●



60x60 (24"x24")
8600585 nat. rett. 78 ●
8600825 sat. rett. 78 ●



30x60 (12"x24")
8600645 nat. rett. 78 ●
8600885 sat. rett. 78 ●



30x60 (12"x24")
7694845 nat. non rett. 68 ●
29,7x59,5 (12"x24")
7697035 nat. rett. 76 ●

mosaico 5x5 (2"x2") 124 ●



30x30 (12"x12")
7694965 nat.

almond



icon TILE+



90x270 (36"x106")
T621715 matt rett. 107 ●
T621775 sat. rett. 107 ●



90x90 (36"x36")
T621355 matt rett. 94 ●
T621475 sat. rett. 94 ●



45x90 (18"x36")
T621465 matt rett. 94 ●
T621535 sat. rett. 94 ●



30x90 (12"x36")
T621595 matt rett. 94 ●
T621655 sat. rett. 94 ●

icon standard



60x120 (24"x47")
8600475 nat. rett. 86 ●
8600715 sat. rett. 86 ●



60x60 (24"x24")
8600535 nat. rett. 78 ●
8600775 sat. rett. 78 ●



30x60 (12"x24")
8600615 nat. rett. 78 ●
8600835 sat. rett. 78 ●



30x60 (12"x24")
7694795 nat. non rett. 68 ●



29,7x59,5 (12"x24")
7694975 nat. rett. 76 ●

mosaico 5x5 (2"x2") 124 ●



30x30 (12"x12")
7694915 nat.

icon | concrete and terracotta effect

artic



icon TILE+



90x270 (36"x106")
T621665 matt rett. 107 ●
T621725 sat. rett. 107 ●



90x90 (36"x36")
T621305 matt rett. 94 ●
T621365 sat. rett. 94 ●



45x90 (18"x36")
T621415 matt rett. 94 ●
T621485 sat. rett. 94 ●



30x90 (12"x36")
T621545 matt rett. 94 ●
T621605 sat. rett. 94 ●

icon standard



60x120 (24"x47")
8600485 nat. rett. 86 ●
8600725 sat. rett. 86 ●



60x60 (24"x24")
8600545 nat. rett. 78 ●
8600785 sat. rett. 78 ●



30x60 (12"x24")
8600595 nat. rett. 78 ●
8600845 sat. rett. 78 ●



30x60 (12"x24")
7694805 nat. non rett. 68 ●
29,7x59,5 (12"x24")
7694995 nat. rett. 76 ●

mosaico 5x5 (2"x2") 124 ●



30x30 (12"x12")
7694925 nat.

ash



icon TILE+



90x270 (36"x106")
T621695 matt rett. 107 ●
T621755 sat. rett. 107 ●



90x90 (36"x36")
T621335 matt rett. 94 ●
T621395 sat. rett. 94 ●



45x90 (18"x36")
T621445 matt rett. 94 ●
T621515 sat. rett. 94 ●



30x90 (12"x36")
T621575 matt rett. 94 ●
T621635 sat. rett. 94 ●

icon standard



60x120 (24"x47")
8600495 nat. rett. 86 ●
8600735 sat. rett. 86 ●



60x60 (24"x24")
8600555 nat. rett. 78 ●
8600795 sat. rett. 78 ●



30x60 (12"x24")
8600605 nat. rett. 78 ●
8600855 sat. rett. 78 ●



30x60 (12"x24")
7694815 nat. non rett. 68 ●

29,7x59,5 (12"x24")
7697005 nat. rett. 76 ●

mosaico 5x5 (2"x2") 124 ●



30x30 (12"x12")
7694935 nat.

icon | concrete and terracotta effect

taupe

icon | concrete and terracotta effect



icon TILE+



90x270 (36"x106")
T621705 matt rett. 107 ●
T621765 sat. rett. 107 ●



90x90 (36"x36")
T621345 matt rett. 94 ●
T621405 sat. rett. 94 ●



45x90 (18"x36")
T621455 matt rett. 94 ●
T621525 sat. rett. 94 ●



30x90 (12"x36")
T621585 matt rett. 94 ●
T621645 sat. rett. 94 ●

icon standard



60x120 (24"x47")
8600515 nat. rett. 86 ●
8600755 sat. rett. 86 ●



60x60 (24"x24")
8600575 nat. rett. 78 ●
8600815 sat. rett. 78 ●



30x60 (12"x24")
8600635 nat. rett. 78 ●
8600875 sat. rett. 78 ●



30x60 (12"x24")
7694835 nat. non rett. 68 ●

29,7x59,5 (12"x24")
7697025 nat. rett. 76 ●

mosaico 5x5 (2"x2") 124 ●



30x30 (12"x12")
7694955 nat.

grey



icon TILE+



90x270 (36"x106")
T621685 matt rett. 107 ●
T621745 sat. rett. 107 ●



90x90 (36"x36")
T621325 matt rett. 94 ●
T621385 sat. rett. 94 ●



45x90 (18"x36")
T621435 matt rett. 94 ●
T621505 sat. rett. 94 ●



30x90 (12"x36")
T621565 matt rett. 94 ●
T621625 sat. rett. 94 ●

icon standard



60x120 (24"x47")
8600505 nat. rett. 86 ●
8600745 sat. rett. 86 ●



60x60 (24"x24")
8600565 nat. rett. 78 ●
8600805 sat. rett. 78 ●



30x60 (12"x24")
8600625 nat. rett. 78 ●
8600865 sat. rett. 78 ●



30x60 (12"x24")
7694825 nat. non rett. 68 ●
29,7x59,5 (12"x24")
7697015 nat. rett. 76 ●

mosaico 5x5 (2"x2") 124 ●



30x30 (12"x12")
7694945 nat.

icon | concrete and terracotta effect

PEZZI SPECIALI trims - pieces speciales - formstücke - СОБИЕЭЛЕМЕНТЫ

icon
TILE+ #6



battiscopa matt rett.
7,5x90 (3"x36")
T621596 almond matt. rett.
T621546 artic matt. rett.
T621576 ash matt. rett.
T621566 grey matt. rett.
T621586 taupe matt. rett.
T621556 white matt. rett.
40 ▲ 5 ◻

icon
standard #9

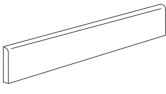

battiscopa rett.
7,5x60 (3"x24")
8600617 almond nat. rett.
8600597 artic nat. rett.
8600857 ash nat. rett.
8600627 grey nat. rett.
8600637 taupe nat. rett.
8600647 white nat. rett.
24 ▲ 14 ◻

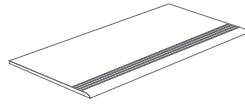

gradino step naturale rett.
30x60 (12"x24")
8600616 almond nat. rett.
8600596 artic nat. rett.
8600606 ash nat. rett.
8600626 grey nat. rett.
8600636 taupe nat. rett.
8600646 white nat. rett.
48 ▲ 7 ◻

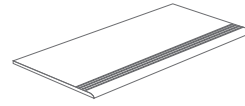

gradino step satinato rett.
30x60 (12"x24")
8600836 almond sat. rett.
8600846 artic sat. rett.
8600856 ash sat. rett.
8600866 grey sat. rett.
8600876 taupe sat. rett.
8600886 white sat. rett.
48 ▲ 7 ◻

icon concrete and terracotta effect

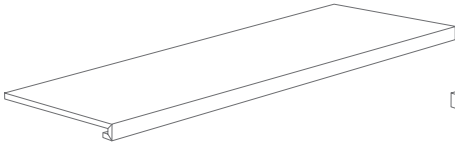

* gradone CR naturale rett.
33,3x120 (13"x47")
8600476 almond nat. rett.
8600486 artic nat. rett.
8600496 ash nat. rett.
8600506 grey nat. rett.
8600516 taupe nat. rett.
8600526 white nat. rett.
141 ▲ 2 ◻

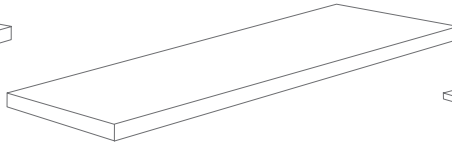

* angolare CR SX naturale rett.
33,3x120 (13"x47")
8600478 almond nat. rett.
8600488 artic nat. rett.
8600498 ash nat. rett.
8600508 grey nat. rett.
8600518 taupe nat. rett.
8600528 white nat. rett.
148 ▲ 2 ◻

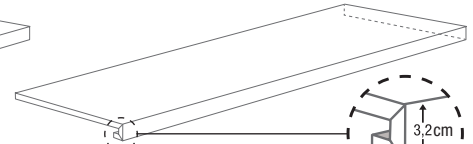

* angolare CR DX naturale rett.
33,3x120 (13"x47")
8600477 almond nat. rett.
8600487 artic nat. rett.
8600497 ash nat. rett.
8600507 grey nat. rett.
8600517 taupe nat. rett.
8600527 white nat. rett.
148 ▲ 2 ◻

* gradone CR satinato rett.
33,3x120 (13"x47")
8600716 almond sat. rett.
8600726 artic sat. rett.
8600736 ash sat. rett.
8600746 grey sat. rett.
8600756 taupe sat. rett.
8600766 white sat. rett.
141 ▲ 2 ◻

* angolare CR SX satinato rett.
33,3x120 (13"x47")
8600718 almond sat. rett.
8600728 artic sat. rett.
8600738 ash sat. rett.
8600748 grey sat. rett.
8600758 taupe sat. rett.
8600768 white sat. rett.
148 ▲ 2 ◻

* angolare CR DX satinato rett.
33,3x120 (13"x47")
8600717 almond sat. rett.
8600727 artic sat. rett.
8600737 ash sat. rett.
8600747 grey sat. rett.
8600757 taupe sat. rett.
8600767 white sat. rett.
148 ▲ 2 ◻



icon

icon | concrete and terracotta effect

wall: white 30x90 (12"x36"), 90x270 (36"x106"), ash 90x270 (36"x106")
 floor: ash 90x90 (36"x36")

IMBALLI packing - emballages - verpackung - УПАКОВКА

TILE+		mm.	TIPOLOGIA IMBALLO / PACKAGING		LASTRA / SLAB			CASSA - CAVALLETTO / CRATE - A-FRAME			
			ARTICOLO / ITEM	DIMENSIONE / SIZE	PCS	M2	KG	PCS	M2	KG VUOTO/EMPTY	KG TOT
90x270	rett.	6	1 cassa / crate	106x297	1	2,43	38	22	53,46	93	929
90x90	rett.	6	pallet con sponda	94x124	3	2,43	12,66	78	63,10	14	1001,5
45x90	rett.	6		94x124	5	2,025	6,08	150	60,75	14	926
30x90	rett.	6		100x120	6	1,62	4,15	180	48,60	14	761

STANDARD		mm.	PCS / BOX	M2 / BOX	BOX / PLT	M2 / PLT	KG. / PLT
60x120	rett.	9	2	1,44	36	51,84	1170
60x60	rett.	9	3	1,080	40	43,20	900
30x60	rett.	9	7	1,26	40	50,40	1120
30x60	non rett.	9	7	1,26	40	50,40	989,20
29,7x59,5	rett.	9	7	1,24	40	49,60	1000
30x30	mosaico	9	11	1	30	30	570

* Per casse complete con un unico articolo la cassa viene fornita gratuita. Per vendite inferiori alla cassa completa la cassa viene addebitata al costo di € 70,00

If a crate is complete and contains one single item the crate is supplied free of charge. If a crate is not complete the crate is charged at a cost of €70.00

Bei kompletten Kisten, die einen einzigen Artikel enthalten, wird die Kiste nicht berechnet. Bei Verkäufen nicht kompletter Kisten werden die Kisten zum Preis von € 70,00 berechnet.

Pour des caisses remplies avec un seul article, celles-ci seront fournies gratuitement. Pour des ventes qui ne remplissent pas la caisse, celle-ci est vendue à un prix de 70,00 €

Ящики, заполненные полностью одним артикулом, поставляются бесплатно. При продаже количества меньше одного полного ящика взимается плата в размере 70,00 € за ящик

icon roc | concrete | scotta effect



icon roc

white roc



ash roc



30x60 (12"x24")

non rett.

68 ●

- 7694905 white roc
- 7694855 almond roc
- 7694865 artic roc
- 7694875 ash roc
- 7694895 taupe roc
- 7694885 grey roc

almond roc

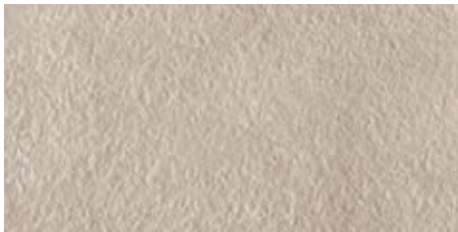

taupe roc



artic roc

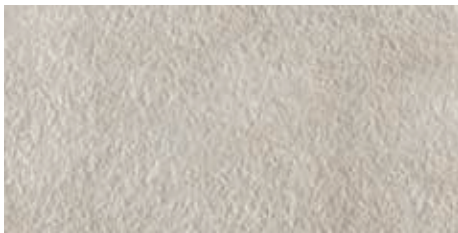

grey roc



POSA 1/4



FUGA >3 mm



DIN 51130
R11



DIN 51097
A+B+C

icon roc | concrete and terracotta effect

PEZZI SPECIALI trims - pieces speciales - formstücke - СОБИЕЭЛЕМЕНТЫ

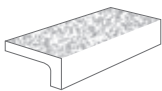

elemento elle pressa

15x30x3,5 (6"x12"x1,4")

- 7694866 artic
- 7694876 ash
- 7694886 grey
- 7694896 taupe
- 7694906 white

44 ▲ 8 ◻

IMBALLI packing - emballages - verpackung - УПАКОВКА

F.TO NOMINALE / NOMINAL SIZE	mm.	PCS / BOX	M2 / BOX	BOX / PLT	M2 / PLT	KG. / PLT
30x60 non rett.	9	7	1,26	40	50,40	989,20

logica | concrete and terracotta effect



COLORI

colours - couleurs - farbe - ЦВЕТА

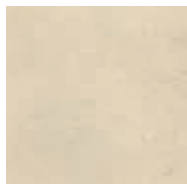

beige

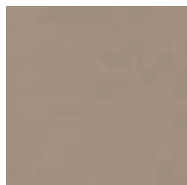

camel

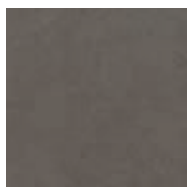

moro

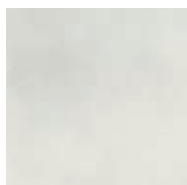

bianco

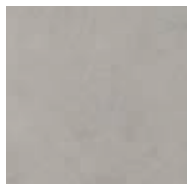

grigio



nero

FORMATI

sizes - formats - format - ФОРМАТЫ



30x60 (12"x24")



45x45 (18"x18")



33,3x33,3 (13"x13")

GS

V1



POSA 1/4



FUGA >3 mm

logica | concrete and terracotta effect

bianco



beige



grigio



camel



nero



moro



logica | concrete and terracotta effect



30x60 (12"x24") 64 ●
 7667955 beige
 7675365 camel
 7667945 bianco
 7667965 grigio
 7667975 nero
 7675355 moro



33,3x33,3 (13"x13") 60 ●
 7662736 beige
 7662926 camel
 7662726 bianco
 7662746 grigio
 7662792 nero
 7662916 moro



45x45 (18"x18") 64 ●
 7690116 beige
 7690226 camel
 7690106 bianco
 7690126 grigio
 7690136 nero
 7690215 moro

mosaico 5x5 (2"x2") 124 ●



30x30 (12"x12")
 7669765 bianco

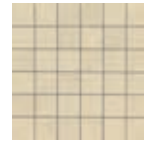

30x30 (12"x12")
 7669755 beige



30x30 (12"x12")
 7675375 moro



30x30 (12"x12")
 7669775 grigio

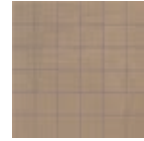

30x30 (12"x12")
 7675385 camel

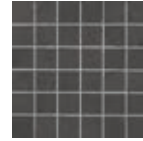

30x30 (12"x12")
 7669795 nero

PEZZI SPECIALI trims - pieces speciales - formstücke - СОБЫЕЭЛЕМЕНТЫ

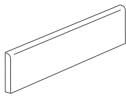

battiscopa
8x33,3 (3,2"x13")
 7662815 bianco
 7662835 grigio
 7662845 nero
 7662825 beige
 7662965 camel
 7662955 moro

12 ▲ 32 ◻

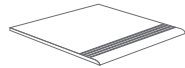

gradino step
33,3x33,3 (13"x13")
 7662865 bianco
 7662885 grigio
 7662905 nero
 7662875 beige
 7662945 camel
 7662935 moro

42 ▲ 13 ◻

IMBALLI packing - emballages - verpackung - УПАКОВКА

F.TO NOMINALE / NOMINAL SIZE	mm.	PCS / BOX	M2 / BOX	BOX / PLT	M2 / PLT	KG. / PLT
30x60	9	7	1,26	40	50,40	1000
45x45	9	7	1,42	52	73,84	1274
33,3x33,3	7,5	13	1,44	44	63,36	969
30x30 mosaico	9	11	1	32	32	643,20

neutra | concrete and terracotta effect



COLORI

colours - couleurs - farbe - ЦВЕТА

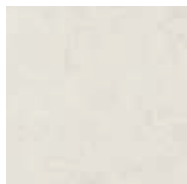

bianco



latte

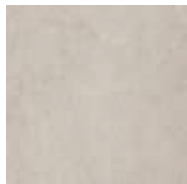

tortora

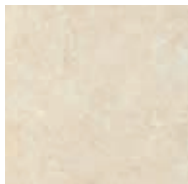

avorio

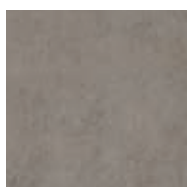

piombo

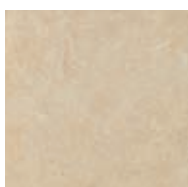

beige

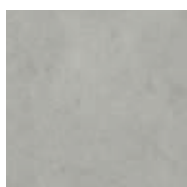

grigio

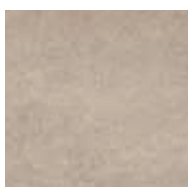

ecrù



nero

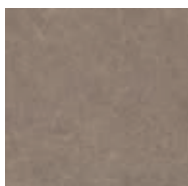

marrone

FORMATI

sizes - formats - format - ФОРМАТЫ

naturale - lappato

formati modulari

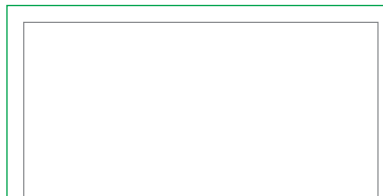

60x120 (24"x47") RETT. $\neq 9$



60x60 (24"x24") RETT. $\neq 9$



30x60 (12"x24") RETT. $\neq 9$

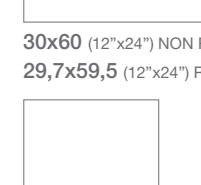

30x60 (12"x24") NON RETT.
29,7x59,5 (12"x24") RETT. $\neq 9$



45x45 (18"x18") NON RETT.
44,5x44,5 (18"x18") RETT. $\neq 9$



30x30 (12"x12") NON RETT. $\neq 8$

grip

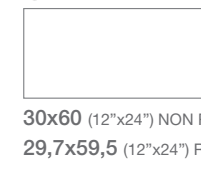

30x60 (12"x24") NON RETT.
29,7x59,5 (12"x24") RETT. $\neq 9$

> pag. 254

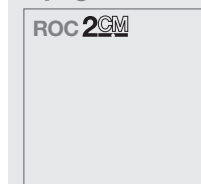

60x60 (24"x24") RETT. $\neq 20$

3 FINITURE

finishes - surfaces

Oberfläche - ПОВЕРХНОСТИ

Naturale

Lappato

Grip



FUGA 2 mm
PER RETT.



FUGA >3 mm
PER NON RETT.



DIN 51130
R11 (GRIP)



DIN 51097
A+B+C (GRIP)



60x60
U4P4E3C2



45x45
U4P4E3C2



30x60
U4P3E3C2

neutra | concrete and terracotta effect

tortora



piombo



grigio



neutra | concrete and terracotta effect

naturale/lappato

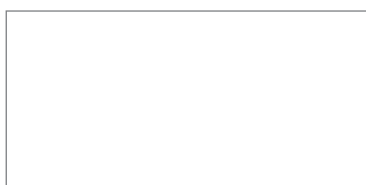

60x120 (24"x47")

rett.

86 ●

8600561 tortora nat. rett.
8600551 piombo nat. rett.
8600511 grigio nat. rett.
8600541 nero nat. rett.
8600491 bianco nat. rett.

lappato rett.

96 ●

8600311 tortora lapp. rett.
8600301 piombo lapp. rett.
8600261 grigio lapp. rett.
8600291 nero lapp. rett.
8600231 bianco lapp. rett.



60x60 (24"x24")

rett.

78 ●

8600560 tortora nat. rett.
8600550 piombo nat. rett.
8600510 grigio nat. rett.
8600540 nero nat. rett.
8600490 bianco nat. rett.

lappato rett.

88 ●

8600310 tortora lapp. rett.
8600300 piombo lapp. rett.
8600260 grigio lapp. rett.
8600290 nero lapp. rett.
8600230 bianco lapp. rett.



30x60 (12"x24")

rett.

78 ●

8600562 tortora nat. rett.
8600552 piombo nat. rett.
8600512 grigio nat. rett.
8600542 nero nat. rett.
8600492 bianco nat. rett.

lappato rett.

88 ●

8600312 tortora lapp. rett.
8600302 piombo lapp. rett.
8600262 grigio lapp. rett.
8600292 nero lapp. rett.
8600232 bianco lapp. rett.



30x60 (12"x24")

non rett.

68 ●

7669881 tortora nat.
7669861 piombo nat.
7669871 grigio nat.
7669851 nero nat.
7679621 bianco nat.

29,7x59,5 (12"x24")

rett.

76 ●

7670151 tortora nat. rett.
7670131 piombo nat. rett.
7670141 grigio nat. rett.
7670121 nero nat. rett.
7679641 bianco nat. rett.

nero



bianco

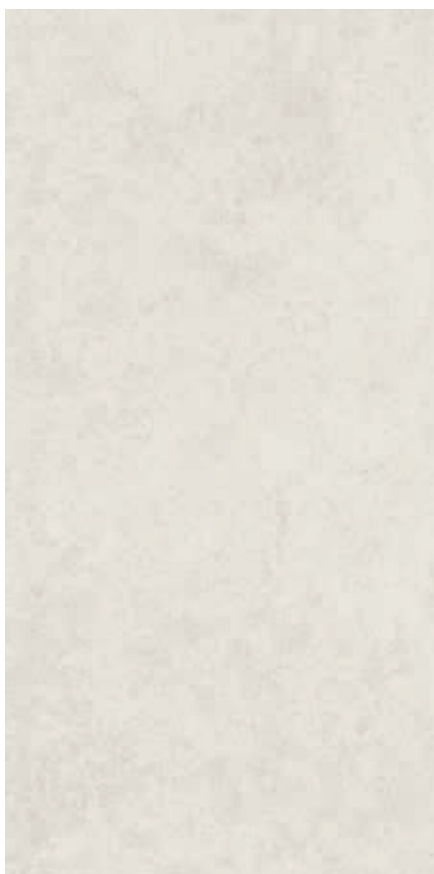

mosaico 5x5 (2"x2") 124 ●



30x30 (12"x12")
7670231 tortora nat.



30x30 (12"x12")
7670221 piombo nat.

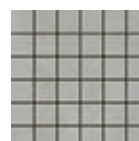

30x30 (12"x12")
7670201 grigio nat.



30x30 (12"x12")
7670211 nero nat.



30x30 (12"x12")
7679671 bianco nat.

neutra | concrete and terracotta effect



45x45 (18"x18")
non rett. 64 ●
7652181 tortora nat.
7652201 piombo nat.
7652191 grigio nat.
7652211 nero nat.
7679595 bianco nat.



30x30 (12"x12")
non rett. 62 ●
7666721 tortora nat.
7666751 piombo nat.
7666761 grigio nat.
7666791 nero nat.
7679581 bianco nat.

grip



30x60 (12"x24")
grip non rett. 68 ●
7681201 tortora grip
7673101 piombo grip
7673091 grigio grip
7681211 nero grip
7681225 bianco grip

29,7x59,5 (12"x24")
grip rett. 76 ●
7681331 tortora grip rett.
7681311 piombo grip rett.
7681301 grigio grip rett.
7681341 nero grip rett.
7681351 bianco grip rett.

44,5x44,5 (18"x18")
rett. 76 ●
7652675 tortora nat. rett.
7652665 piombo nat. rett.
7652625 grigio nat. rett.
7652655 nero nat. rett.
7679605 bianco nat. rett.

latte



ecrù



marrone



neutra | concrete and terracotta effect

naturale/lappato



60x120 (24"x47")

rett.

86 ●

8600521 latte nat. rett.
8600501 ecrù nat. rett.
8600531 marrone nat. rett.
8600471 avorio nat. rett.
8600481 beige nat. rett.

lappato rett.

96 ●

8600271 latte lapp. rett.
8600251 ecrù lapp. rett.
8600281 marrone lapp. rett.
8600221 avorio lapp. rett.
8600241 beige lapp. rett.



60x60 (24"x24")

rett.

78 ●

8600520 latte nat. rett.
8600500 ecrù nat. rett.
8600530 marrone nat. rett.
8600470 avorio nat. rett.
8600480 beige nat. rett.

lappato rett.

88 ●

8600270 latte lapp. rett.
8600250 ecrù lapp. rett.
8600280 marrone lapp. rett.
8600220 avorio lapp. rett.
8600240 beige lapp. rett.



30x60 (12"x24")

rett.

78 ●

8600522 latte nat. rett.
8600502 ecrù nat. rett.
8600532 marrone nat. rett.
8600472 avorio nat. rett.
8600482 beige nat. rett.

lappato rett.

88 ●

8600272 latte lapp. rett.
8600252 ecrù lapp. rett.
8600282 marrone lapp. rett.
8600222 avorio lapp. rett.
8600242 beige lapp. rett.



30x60 (12"x24")

non rett.

68 ●

7692301 latte nat.
7692281 ecrù nat.
7692291 marrone nat.
7670371 avorio nat.
7670361 beige nat.

29,7x59,5 (12"x24")

rett.

76 ●

7692331 latte nat. rett.
7692311 ecrù nat. rett.
7692321 marrone nat. rett.
7670391 avorio nat. rett.
7670381 beige nat. rett.

avorio



beige



mosaico 5x5 (2"x2") 124 ●

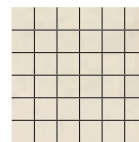

30x30 (12"x12")
7692451 latte nat.

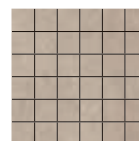

30x30 (12"x12")
7692431 ecrù nat.

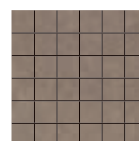

30x30 (12"x12")
7692441 marrone nat.



30x30 (12"x12")
7670431 avorio nat.



30x30 (12"x12")
7670421 beige nat.

neutra | concrete and terracotta effect



45x45 (18"x18")
non rett. 64 ●
7652231 avorio nat.

44,5x44,5 (18"x18")
rett. 76 ●
7652635 avorio nat. rett.



30x30 (12"x12")
non rett. 62 ●
7666711 avorio nat.

grip



30x60 (12"x24")
grip non rett. 68 ●
7692481 latte grip
7692461 ecrù grip
7692471 marrone grip
7673111 avorio grip
7681231 beige grip

29,7x59,5 (12"x24")
grip rett. 76 ●
7692511 latte grip rett.
7692491 ecrù grip rett.
7692501 marrone grip rett.
7681321 avorio grip rett.
7681361 beige grip rett.

PEZZI SPECIALI trims - pieces speciales - formstücke - СОБИЕЭЛЕМЕНТЫ

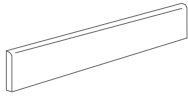

battiscopa non rett.
7,5x60 (3"x24")
 7670591 grigio nat.
 7670631 avorio nat.
 7670621 beige nat.
 7670611 nero nat.
 7670601 piombo nat.
 7670581 tortora nat.
 7679642 bianco nat.
 7692303 latte nat.
 7692283 ecrù nat.
 7692293 marrone nat.
 24 ▲ 14 📦

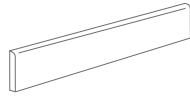

battiscopa rett.
7,5x60 (3"x24")
 8600513 grigio nat. rett.
 8600473 avorio nat. rett.
 8600483 beige nat. rett.
 8600543 nero nat. rett.
 8600553 piombo nat. rett.
 8600563 tortora nat. rett.
 8600493 bianco nat. rett.
 8600523 latte nat. rett.
 8600503 ecrù nat. rett.
 8600533 marrone nat. rett.
 24 ▲ 14 📦

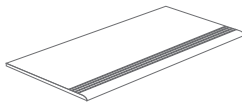

gradino step non rett.
30x60 (12"x24")
 7674427 grigio nat.
 7674428 avorio nat.
 7674426 beige nat.
 7674424 nero nat.
 7674429 piombo nat.
 7674423 tortora nat.
 7679645 bianco nat.
 7692304 latte nat.
 7692284 ecrù nat.
 7692294 marrone nat.
 48 ▲ 7 📦

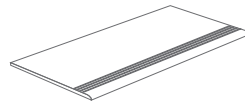

gradino step rett.
30x60 (12"x24")
 8600514 grigio nat. rett.
 8600474 avorio nat. rett.
 8600484 beige nat. rett.
 8600544 nero nat. rett.
 8600554 piombo nat. rett.
 8600564 tortora nat. rett.
 8600494 bianco nat. rett.
 8600524 latte nat. rett.
 8600504 ecrù nat. rett.
 8600534 marrone nat. rett.
 48 ▲ 7 📦

neutra | concrete and terracotta effect

IMBALLI packing - emballages - verpackung - УПАКОВКА

F.TO NOMINALE / NOMINAL SIZE	mm.	PCS / BOX	M2 / BOX	BOX / PLT	M2 / PLT	KG. / PLT
60x120 rett.	9	2	1,44	36	51,84	1170
60x60 rett.	9	3	1,08	40	43,20	900
30x60 rett./non rett.	9	7	1,26	40	50,40	1120
29,7x59,5 rett.	9	7	1,24	40	49,60	1000
45x45 non rett.	9	7	1,42	26	36,92	720,20
44,5x44,5 rett.	9	7	1,39	26	36,14	655,2
30x30 non rett.	8	13	1,17	48	56,16	960
30x30 mosaico	9	11	1	-	-	-

neutra

neutra | concrete and stone

piombo grip 30x60 (24"x36")

saime

175

salento concrete and terracotta effect



bianco



60x60 (24"x24")
rett. 78 ●
8600570 bianco rett.
8600590 sabbia rett.
8600580 grigio rett.

mosaico 5x5 (2"x2") 124 ●

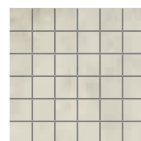

30x30 (12"x12")
7692705 bianco



30x30 (12"x12")
7692715 sabbia



30x30 (12"x12")
7692745 grigio

sabbia



PEZZI SPECIALI
trims - pieces speciales
formstücke - СОБЫЕЭЛЕМЕНТЫ

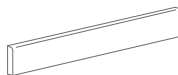

battiscopa rett.
7,5x60 (3"x24")
8600573 bianco rett.
8600583 grigio rett.
8600593 sabbia rett.
24 ▲ 14 ◻

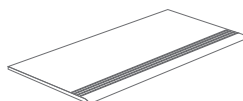

gradino step rett.
30x60 (12"x24")
8600574 bianco rett.
8600584 grigio rett.
8600594 sabbia rett.
48 ▲ 7 ◻

grigio

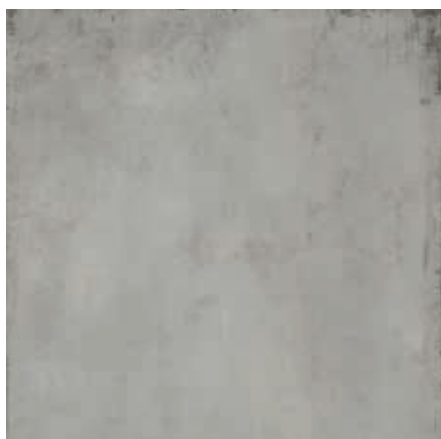

GM

V2



POSA 1/4



FUGA 2 mm

salento | concrete and terracotta effect

IMBALLI packing - emballages - verpackung - УПАКОВКА

F.TO NOMINALE / NOMINAL SIZE	mm.	PCS / BOX	M2 / BOX	BOX / PLT	M2 / PLT	KG. / PLT
60x60 rett.	9	3	1,08	40	43,20	900
30x30 mosaico	9	11	1,00	-	-	-

urbandeck | concrete and terracotta effect

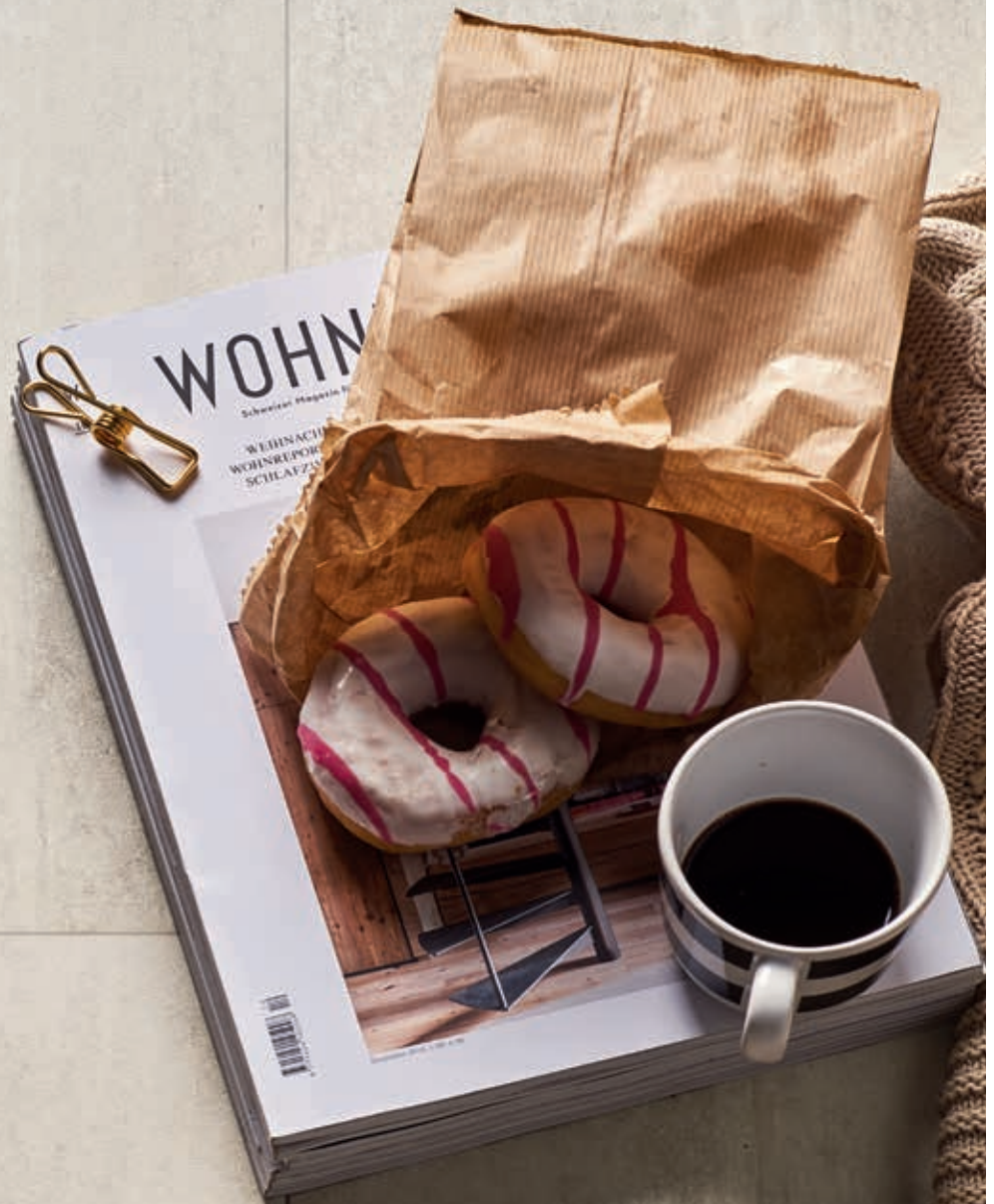

urbandeck

COLORI

colours - couleurs - farbe - ЦВЕТА



white



silver



grey



sand



taupe

FORMATI

sizes - formats - format - ФОРМАТЫ

formati modulari

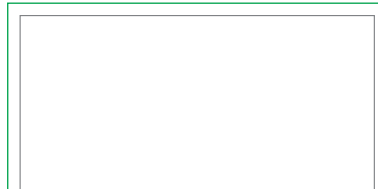

60x120 (24"x47") RETT. #9

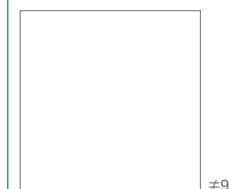

60x60 (24"x24") RETT. #9



30x60 (12"x24") RETT.

> pag. 258

grip 2CM

ONLY: Silver - Grey - Taupe #20

40x120 (16"x47") RETT.

GM

V3



POSA 1/4



FUGA 2 mm

urbandeck | concrete and terracotta effect

white

silver

grey



urbandeck | concrete and terracotta effect



60x120 (24"x47") 86 ●
8600961 grey rett.
8600971 sand rett.
8600981 silver rett.
8600991 taupe rett.
8601001 white rett.



60x60 (24"x24") 78 ●
8600960 grey rett.
8600970 sand rett.
8600980 silver rett.
8600990 taupe rett.
8601000 white rett.



30x60 (12"x24") 78 ●
8600962 grey rett.
8600972 sand rett.
8600982 silver rett.
8600992 taupe rett.
8601002 white rett.

listellato 131 ●



30x60 (12"x24")
7693861 white



30x60 (12"x24")
7693841 silver



30x60 (12"x24")
7693821 grey



30x60 (12"x24")
7693831 sand



30x60 (12"x24")
7693851 taupe

sand

taupe



urbandeck | concrete and terracotta effect

mosaico 5x5 (2"x2") #9 124 ●



30x30 (12"x12")
7693811 white

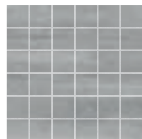

30x30 (12"x12")
7693791 silver

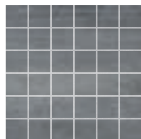

30x30 (12"x12")
7693771 grey

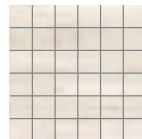

30x30 (12"x12")
7693781 sand

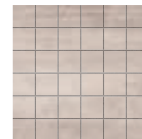

30x30 (12"x12")
7693801 taupe

PEZZI SPECIALI trims - pieces speciales - formstücke - СОБЫЕЭЛЕМЕНТЫ

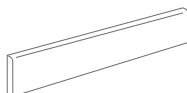

battiscopa rett.
7,5x60 (3"x24")
8601003 white rett.
8600973 sand rett.
8600983 silver rett.
8600993 taupe rett.
8600963 grey rett.
24 ▲ 14 ◻

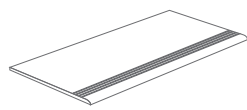

gradino step rett.
30x60 (12"x24")
8601004 white rett.
8600974 sand rett.
8600984 silver rett.
8600994 taupe rett.
8600964 grey rett.
48 ▲ 7 ◻

IMBALLI packing - emballages - verpackung - УПАКОВКА

F.TO NOMINALE / NOMINAL SIZE	mm.	PCS / BOX	M2 / BOX	BOX / PLT	M2 / PLT	KG. / PLT
60x120 rett.	9	2	1,44	36	51,84	1170
60x60 rett.	9	3	1,08	40	43,20	900
30x60 rett.	9	7	1,26	40	50,40	1120
30x30 mosaico	9	11	1,00	-	-	-
30x60 listellato	10	4	0,72	-	-	-

valencia | concrete and terracotta effect



valencia

COLORI

colours - couleurs - farbe - ЦВЕТА



bone



oro

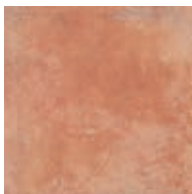

rosso



grigio

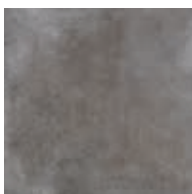

antracite

FORMATI

sizes - formats - format - ФОРМАТЫ

naturale



45x45 (18"x18")



33,3x33,3 (13"x13")

grip (corindonato)



45x45 (18"x18")



33,3x33,3 (13"x13")

2 FINITURE

finishes - surfaces
Oberfläche - ПОВЕРХНОСТИ

Naturale

Grip (Corindonato)

GS

V3



POSA 1/4



FUGA >3 mm



DIN 51130
R10 (GRIP)



DIN 51097
A+B (GRIP)

valencia | concrete and terracotta effect

bone



oro



grigio



rosso



valencia | concrete and terracotta effect

antracite



naturale



45x45 (18"x18") **64** ●
 7652755 antracite
 7952745 grigio
 7689605 bone
 7689595 oro
 7689585 rosso



33,3x33,3 (13"x13") **60** ●
 7657781 antracite
 7657761 grigio
 7644750 bone
 7663581 oro
 7644790 rosso

grip (corindonato)



45x45 (18"x18") **64** ●
 7652775 antracite cor.
 7652765 grigio cor.
 7689635 bone cor.
 7689625 oro cor.
 7689615 rosso cor.



33,3x33,3 (13"x13") **60** ●
 7657791 antracite cor.
 7657771 grigio cor.
 7666471 bone cor.
 7666461 oro cor.
 7666451 rosso cor.

PEZZI SPECIALI trims - pieces speciales - formstücke - СОБЫЕЭЛЕМЕНТЫ

naturale



battiscopa
8x33,3 (3,2"x13")
 7621198 bone
 7621218 oro
 7621228 rosso
 7657809 grigio
 7657819 antracite

12 ▲ **32** ☐



battiscopa
9x45 (3,6"x18")
 7652959 bone
 7652979 oro
 7652989 rosso
 7652969 grigio
 7652949 antracite

18 ▲ **12** ☐

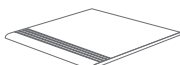

step
33,3x33,3 (13"x13")
 7665582 bone
 7663602 oro
 7654070 rosso
 7654076 grigio
 7654071 antracite

42 ▲ **13** ☐

grip (corindonato)

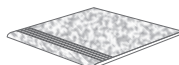

step grip (corindonato)
33,3x33,3 (13"x13")
 7654073 bone cor.
 7663603 oro cor.
 7654072 rosso cor.
 7654074 grigio cor.
 7654075 antracite cor.

42 ▲ **13** ☐

valencia | concrete and terracotta effect

IMBALLI packing - emballages - verpackung - УПАКОВКА

F.TO NOMINALE / NOMINAL SIZE	mm.	PCS / BOX	M2 / BOX	BOX / PLT	M2 / PLT	KG. / PLT
45x45	9	7	1,42	26	36,9	709
33,3x33,3	8	14	1,55	44	68,2	1100

collections 2021

03

marble effect

effetto marmo / imitation marbre

Marmor-Optik / Мрамор

cave		188
cave roc		206
cremo		208
shine		210

cave | marble effect



COLORI

colours - couleurs
farbe - ЦВЕТА

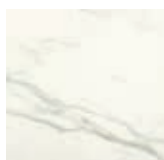

pietrasanta



lasa



forte



onix ice



camaiore

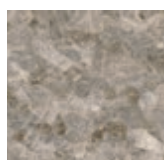

onix diamond

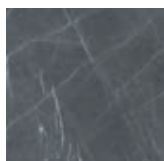

grafite

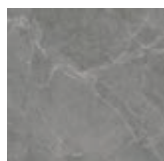

baltic grey



markina

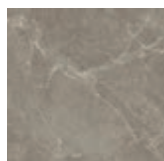

baltic brown



portovenere

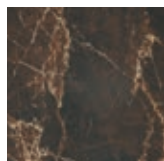

castellon

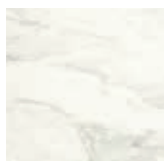

viareggio

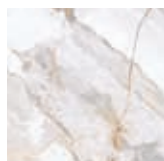

silk

FORMATI TILE+

sizes - formats
format - ФОРМАТЫ

formati modulari

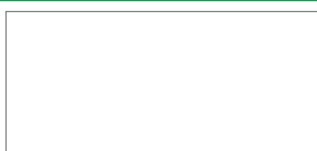

120x260 (47"x102") RETT. $\neq 6,5$



120x120 (47"x47") RETT. $\neq 6,5$



60x120 (24"x47") RETT. $\neq 6,5$

formati modulari

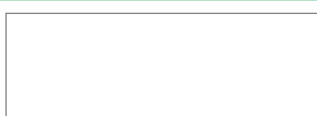

90x270 (36"x106") RETT. $\neq 6$



90x90 (36"x36") RETT. $\neq 6$



45x90 (18"x36") RETT. $\neq 6$

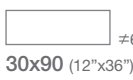

30x90 (12"x36") RETT. $\neq 6$

FORMATI standard

sizes - formats
format - ФОРМАТЫ

formati modulari

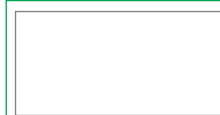

90x180 (36"x71 ") RETT. $\neq 10$



90x90 (36"x36 ") RETT. $\neq 10$

formati modulari



60x120 (24"x47") RETT. $\neq 9$



30x120 (12"x47") RETT. $\neq 9$



60x60 (24"x24") RETT. $\neq 9$



30x60 (12"x24") RETT. $\neq 9$

> pag. 206

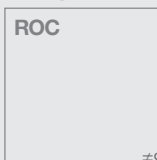

60x60 (24"x24") RETT. $\neq 9$



30x60 (12"x24") RETT. $\neq 9$

2 FINITURE

finishes - surfaces
Oberfläche - ПОВЕРХНОСТИ

Matt

Lucido

GM

V3



POSA 1/4



FUGA 2 mm
PER RETT.

cave | marble effect

pietrasanta

cave | marble effect



cave TILE+

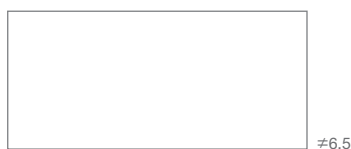

120x260 (47"x102")
T860085 matt rett. 114 ●
T860265 lucido rett. 120 ●



120x120 (47"x47")
T860185 matt rett. 104 ●
T820245 lucido rett. 113 ●



60x120 (24"x47")
T810305 matt rett. 104 ●
T810365 lucido rett. 113 ●



90x270 (36"x106")
T622535 matt rett. 107 ●
T622555 lucido rett. 115 ●



90x90 (36"x36")
T622065 matt rett. 94 ●
T622415 lucido rett. 111 ●



45x90 (18"x36")
T622105 matt rett. 94 ●
T622455 lucido rett. 111 ●



30x90 (12"x36")
T622145 matt rett. 94 ●
T622495 lucido rett. 111 ●

cave standard



90x180 (36"x71")
8680357 matt rett. 107 ●
8680399 lucido rett. 114 ●



90x90 (36"x36")
8680358 matt rett. 93 ●
8680400 lucido rett. 106 ●



60x120 (24"x47")
8600236 matt rett. 88 ●
8600019 lucido rett. 103 ●



30x120 (12"x47")
8681649 matt rett. 88 ●
8682169 lucido rett. 103 ●



60x60 (24"x24")
8600239 matt rett. 82 ●
8600039 lucido rett. 95 ●



30x60 (12"x24")
8600237 matt rett. 82 ●
8600029 lucido rett. 95 ●

mosaico 5x5 (2"x2")



30x30 (12"x12")
7688115 matt 124 ●
7688145 luc. 131 ●

mosaico class 2,3x2,3 (0,9"x0,9") 147 ●



30x30 (12"x12")
7688075 pietrasanta lucido
con tozzetti vetro argento

mosaico intreccio 137 ●



30x30 (12"x12")
7688055 luc.

london in marmo vero real marble 81 ▲



4x29,5 (1,6"x11,5")
7688089 marmo bianco sivec london

pietrasanta running vein 90x270 ≠6

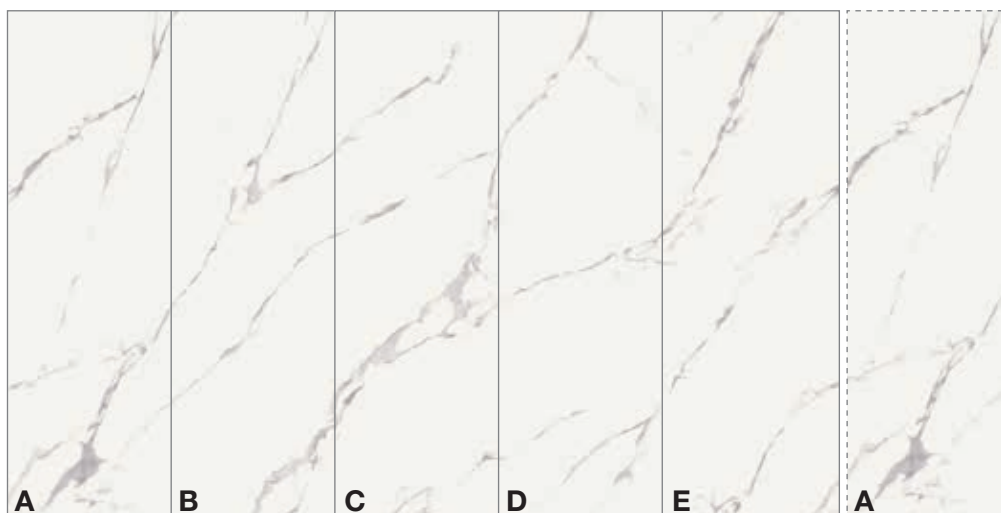

90x270 (36"x106")

matt rett. 121 ●

T622536 A matt rett.

T622537 B matt rett.

T622538 C matt rett.

T622539 D matt rett.

T622540 E matt rett.

lucido rett. 128 ●

T622556 A lucido rett.

T622557 B lucido rett.

T622558 C lucido rett.

T622559 D lucido rett.

T622560 E lucido rett.

pietrasanta bookmatch 90x270 ≠6



90x270 (36"x106")

matt rett. 121 ●

T622637 B1 matt rett.

T622737 B2 matt rett.

lucido rett. 128 ●

T622657 B1 lucido rett.

T622757 B2 lucido rett.

cave | marble effect

pietrasanta bookmatch 120x260 ≠6,5



120x260 (47"x102")

matt rett. 128 ●

T860915 F matt rett.

T860875 B matt rett.

lucido rett. 133 ●

T860735 F lucido rett.

T860655 B lucido rett.

* Eventuali differenze grafiche fino a 1,5 cm tra una lastra e l'altra sono da considerarsi caratteristica del prodotto.

forte

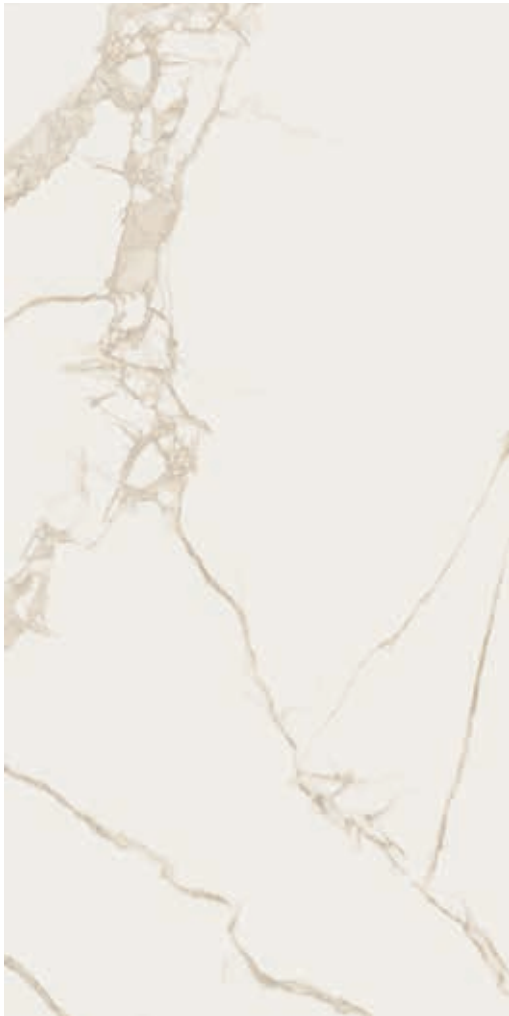

cave TILE+



120x260 (47"x102")
T860115 matt rett. 114 ●
T860295 lucido rett. 120 ●



120x120 (47"x47")
T860215 matt rett. 104 ●
T810275 lucido rett. 113 ●



60x120 (24"x47")
T810335 matt rett. 104 ●
T810395 lucido rett. 113 ●



90x270 (36"x106")
T622545 matt rett. 107 ●
T622565 lucido rett. 115 ●



90x90 (36"x36")
T622075 matt rett. 94 ●
T622425 lucido rett. 111 ●



45x90 (18"x36")
T622115 matt rett. 94 ●
T622465 lucido rett. 111 ●



30x90 (12"x36")
T622155 matt rett. 94 ●
T622505 lucido rett. 111 ●

cave standard



90x180 (36"x71")
8680347 matt rett. 107 ●
8680389 lucido rett. 114 ●



90x90 (36"x36")
8680348 matt rett. 93 ●
8680340 lucido rett. 106 ●



60x120 (24"x47")
8600089 matt rett. 88 ●
8600059 lucido rett. 103 ●



30x120 (12"x47")
8681959 matt rett. 88 ●
8682179 lucido rett. 103 ●



60x60 (24"x24")
8600109 matt rett. 82 ●
8600079 lucido rett. 95 ●



30x60 (12"x24")
8600099 matt rett. 82 ●
8600069 lucido rett. 95 ●

mosaico 5x5 (2"x2")



30x30 (12"x12")
7688105 matt 124 ●
7688135 lucido 131 ●

mosaico class 2,3x2,3 (0,9"x0,9") 147 ●



30x30 (12"x12")
7688085 forte lucido
 con tozzetti vetro oro

mosaico intreccio 137 ●



30x30 (12"x12")
7688065 lucido

forte running vein 90x270 #6



90x270 (36"x106")

matt rett. 121 ●

T622546 A matt rett.

T622547 B matt rett.

T622548 C matt rett.

T622549 D matt rett.

T622550 E matt rett.

lucido rett. 128 ●

T622566 A lucido rett.

T622567 B lucido rett.

T622568 C lucido rett.

T622569 D lucido rett.

T622570 E lucido rett.

forte bookmatch 90x270 #6



90x270 (36"x106")

matt rett. 121 ●

T622647 B1 matt rett.

T622747 B2 matt rett.

lucido rett. 128 ●

T622667 B1 lucido rett.

T622767 B2 lucido rett.

cave | marble effect

forte bookmatch 120x260 #6,5



120x260 (47"x102")

matt rett. 128 ●

T860835 F matt rett.

T860795 B matt rett.

lucido rett. 133 ●

T861095 F lucido rett.

T861055 B lucido rett.

* Eventuali differenze grafiche fino a 1,5 cm tra una lastra e l'altra sono da considerarsi caratteristica del prodotto.

grafite

cave | marble effect



cave TILE+



120x260 (47"x102")
T860095 matt rett. 114 ●
T860275 lucido rett. 120 ●



120x120 (47"x47")
T860195 matt rett. 104 ●
T810255 lucido rett. 113 ●



60x120 (24"x47")
T810315 matt rett. 104 ●
T810375 lucido rett. 113 ●



90x270 (36"x106")
T622615 matt rett. 107 ●
T622635 lucido rett. 115 ●



90x90 (36"x36")
T622085 matt rett. 94 ●
T622435 lucido rett. 111 ●



45x90 (18"x36")
T622125 matt rett. 94 ●
T622475 lucido rett. 111 ●



30x90 (12"x36")
T622165 matt rett. 94 ●
T622515 lucido rett. 111 ●

cave standard



90x180 (36"x71")
8683038 matt rett. 107 ●
8683058 lucido rett. 114 ●



90x90 (36"x36")
8683039 matt rett. 93 ●
8683059 lucido rett. 106 ●



60x120 (24"x47")
8600246 matt rett. 88 ●
8600209 lucido rett. 103 ●



30x120 (12"x47")
8600245 matt rett. 88 ●
8600208 lucido rett. 103 ●



60x60 (24"x24")
8600249 matt rett. 82 ●
8600229 lucido rett. 95 ●



30x60 (12"x24")
8600247 matt rett. 82 ●
8600219 lucido rett. 95 ●

mosaico 5x5 (2"x2")



30x30 (12"x12")
7694576 matt 124 ●
7694516 lucido 131 ●

markina

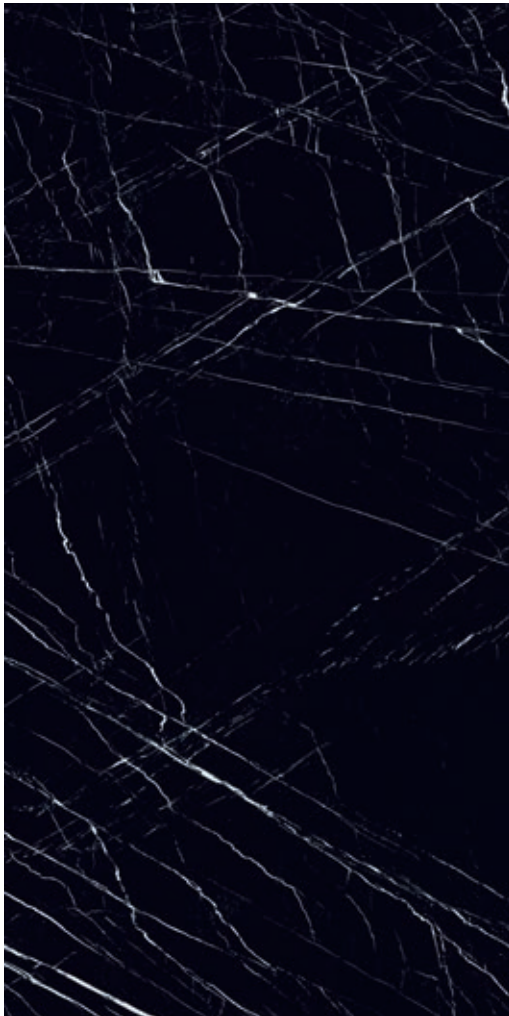

cave TILE+



120x260 (47"x102")
T801155 lucido rett. 120 ●



120x120 (47"x47")
T813265 lucido rett. 113 ●



60x120 (24"x47")
T813275 lucido rett. 113 ●



90x270 (36"x106")
T622625 matt rett. 107 ●
T622645 lucido rett. 115 ●



90x90 (36"x36")
T622095 matt rett. 94 ●
T622445 lucido rett. 111 ●



45x90 (18"x36")
T622135 matt rett. 94 ●
T622485 lucido rett. 111 ●



30x90 (12"x36")
T622175 matt rett. 94 ●
T622525 lucido rett. 111 ●

cave standard



60x120 (24"x47")
8601236 matt rett. 88 ●
8601019 lucido rett. 103 ●



30x120 (12"x47")
8602236 matt rett. 88 ●
8602119 lucido rett. 103 ●



60x60 (24"x24")
8601239 matt rett. 82 ●
8601039 lucido rett. 95 ●



30x60 (12"x24")
8601237 matt rett. 82 ●
8601029 lucido rett. 95 ●

mosaico 5x5 (2"x2")



30x30 (12"x12")
7601239 matt 124 ●
7690755 lucido 131 ●

cave | marble effect

baltic grey

cave | marble effect



cave TILE+



120x260 (47"x102")
T801445 matt rett. 114 ●
T801455 lucido rett. 120 ●



120x120 (47"x47")
T801446 matt rett. 104 ●
T801456 lucido rett. 113 ●



60x120 (24"x47")
T801447 matt rett. 104 ●
T801457 lucido rett. 113 ●

cave standard



90x180 (36"x71")
8683278 matt rett. 107 ●
8683238 lucido rett. 114 ●



60x120 (24"x47")
8601911 matt rett. 88 ●
8601901 lucido rett. 103 ●



60x60 (24"x24")
8601912 matt rett. 82 ●
8601902 lucido rett. 95 ●



30x60 (12"x24")
8601913 matt rett. 82 ●
8601903 lucido rett. 95 ●

mosaico 5x5 (2"x2")



30x30 (12"x12")
7601914 matt 124 ●
7601904 luc. 131 ●

baltic brown



cave TILE+

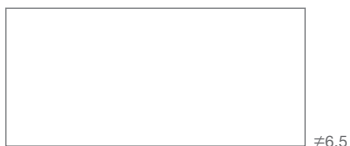

120x260 (47"x102")
T801465 matt rett. 114 ●
T801475 lucido rett. 120 ●



120x120 (47"x47")
T801466 matt rett. 104 ●
T801476 lucido rett. 113 ●



60x120 (24"x47")
T801467 matt rett. 104 ●
T801477 lucido rett. 113 ●

cave standard



90x180 (36"x71")
8683298 matt rett. 107 ●
8683257 lucido rett. 114 ●

cave | marble effect

lasa



cave TILE+



120x260 (47"x102")
 T861435 matt rett. 114 ●
 T861035 lucido rett. 120 ●



120x120 (47"x47")
 T801485 matt rett. 104 ●
 T813175 lucido rett. 113 ●



60x120 (24"x47")
 T801495 matt rett. 104 ●
 T813195 lucido rett. 113 ●

cave standard



90x180 (36"x71")
 8680539 matt rett. 107 ●
 8680527 lucido rett. 114 ●



90x90 (36"x36")
 8683369 matt rett. 93 ●
 8680526 lucido rett. 106 ●



60x120 (24"x47")
 8651145 matt rett. 88 ●
 8651155 lucido rett. 103 ●



30x120 (12"x47")
 8651165 matt rett. 88 ●
 8651175 lucido rett. 103 ●



60x60 (24"x24")
 8694435 matt rett. 82 ●
 8694445 lucido rett. 95 ●



30x60 (12"x24")
 8651185 matt rett. 82 ●
 8601029 lucido rett. 95 ●

mosaico 5x5 (2"x2")



30x30 (12"x12")
 7694465 matt 124 ●
 7694455 luc. 131 ●

silk



**cave
TILE+**



120x260 (47"x102")
T801975 lucido rett. 120 ●



120x120 (47"x47")
T801976 lucido rett. 113 ●



60x120 (24"x47")
T801977 lucido rett. 113 ●

cave | marble effect

onix ice



cave | marble effect

cave TILE+



120x260 (47"x102")
T801305 matt rett. 114 ●
T801285 lucido rett. 120 ●



120x120 (47"x47")
T801306 matt rett. 104 ●
T801286 lucido rett. 113 ●



60x120 (24"x47")
T801307 matt rett. 104 ●
T801287 lucido rett. 113 ●

cave standard



90x180 (36"x71")
8680499 matt rett. 107 ●
8680489 lucido rett. 114 ●

onix diamond

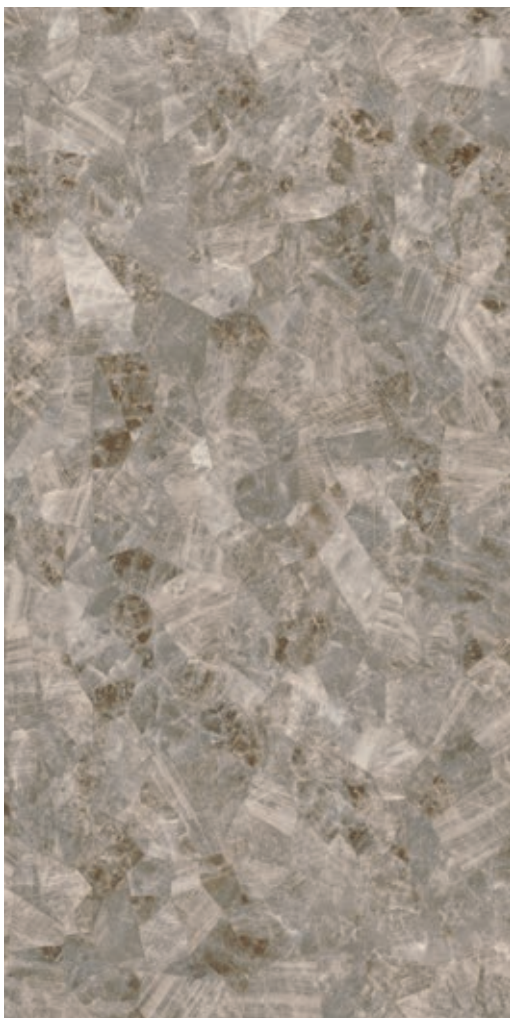

cave TILE+



120x260 (47"x102")
T801325 lucido rett. 120 ●



120x120 (47"x47")
T801326 lucido rett. 113 ●



60x120 (24"x47")
T801327 lucido rett. 113 ●

cave standard



90x180 (36"x71")
8680559 lucido rett. 114 ●

cave | marble effect

portovenere



60x120 (24"x47")
8600179 lucido rett. 103 ●



30x120 (12"x47")
8682199 lucido rett. 103 ●



60x60 (24"x24")
8600199 lucido rett. 95 ●



30x60 (12"x24")
8600189 lucido rett. 95 ●

mosaico 5x5 (2"x2")



30x30 (12"x12")
7690625 matt 124 ●
7690645 luc. 131 ●

mosaico intreccio 137 ●



30x30 (12"x12")
7688066 luc.

cave
standard

viareggio



60x120 (24"x47")
8681579 lucido rett. 103 ●



30x120 (12"x47")
8682189 lucido rett. 103 ●



60x60 (24"x24")
8687495 lucido rett. 95 ●



30x60 (12"x24")
8687515 lucido rett. 95 ●

mosaico 5x5 (2"x2")



30x30 (12"x12")
7688125 matt 124 ●
7688155 luc. 131 ●

london in marmo vero

real marble 81 ▲
4x29,5 (1,6"x11,5")
7688089 marmo bianco sivec london

cave
standard

castellon

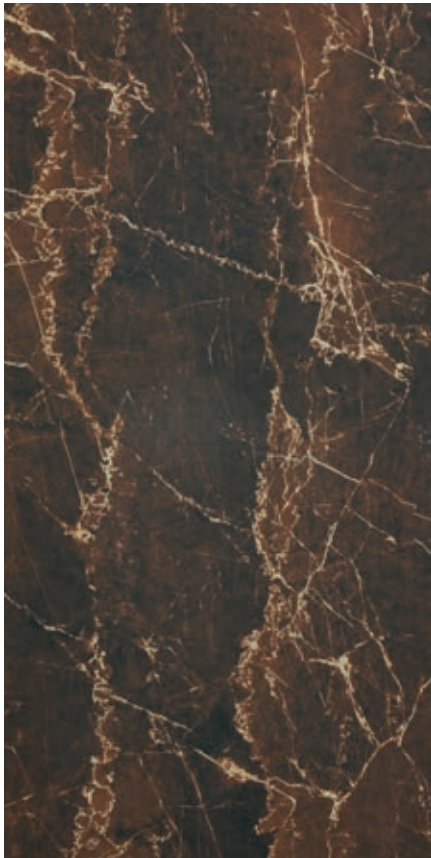

60x120 (24"x47")
8682221 lucido rett. 103 ●



30x120 (12"x47")
8682219 lucido rett. 103 ●



60x60 (24"x24")
8682222 lucido rett. 95 ●



30x60 (12"x24")
8682220 lucido rett. 95 ●

mosaico 5x5 (2"x2")



30x30 (12"x12")
7690635 matt 124 ●
7690655 luc. 131 ●

camaiore



60x120 (24"x47")
8600139 lucido rett. 103 ●



30x120 (12"x47")
8648205 lucido rett. 103 ●



60x60 (24"x24")
8600159 lucido rett. 95 ●



30x60 (12"x24")
8600149 lucido rett. 95 ●

mosaico 5x5 (2"x2")



30x30 (12"x12")
7690765 matt 124 ●
7690755 luc. 131 ●

PEZZI SPECIALI trims - pieces speciales - formstücke - СОБЫЕЭЛЕМЕНТЫ

cave

TILE+ #6



battiscopa 7,5x90 (3"x36")
matt rett.

- T622116 forte matt rett.
- T622106 pietrasanta matt rett.
- T622126 grafite matt rett.
- T622136 markina matt rett.

40 ▲ 5 ◻



battiscopa 7,5x90 (3"x36")
lucido rett.

- T622466 forte lucido rett.
- T622456 pietrasanta lucido rett.
- T622476 grafite lucido rett.
- T622486 markina lucido rett.

43 ▲ 5 ◻

cave

standard #9

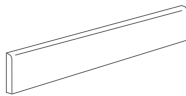

battiscopa 7,5x60 (3"x24")
matt rett.

- 8600309 forte matt rett.
- 8600439 pietrasanta matt rett.
- 8651186 lasa matt rett
- 8694566 grafite matt rett.
- 8601240 markina matt rett.
- 8601914 baltic grey matt rett.

24 ▲ 14 ◻

lucido rett.

- 8600279 forte lucido rett.
- 8600339 pietrasanta lucido rett.
- 8600459 camaiore lucido rett.
- 8653016 lasa lucido rett
- 8600299 portovenere lucido rett.
- 8694626 grafite lucido rett.
- 8601038 markina lucido rett.
- 8601904 baltic grey lucido rett.

28 ▲ 14 ◻

cave | marble effect

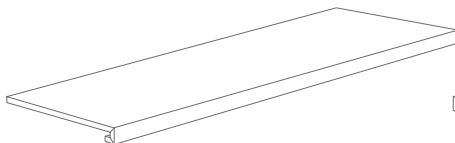

* gradone CR 33,3x120 (13"x47")
matt rett.

- 7688165 forte matt rett.
- 7688175 pietrasanta matt rett.
- 7648196 camaiore matt rett.
- 7651148 lasa matt rett
- 7600244 grafite matt rett.
- 7601238 markina matt rett.
- 7601913 baltic grey matt rett.

141 ▲ 2 ◻

lucido rett.

- 7688195 forte lucido rett.
- 7688205 pietrasanta lucido rett.
- 7648186 camaiore lucido rett.
- 7651158 lasa lucido rett
- 7688598 portovenere lucido rett.
- 7600207 grafite lucido rett.
- 7601158 markina lucido rett.
- 7601903 baltic grey lucido rett.

145 ▲ 2 ◻

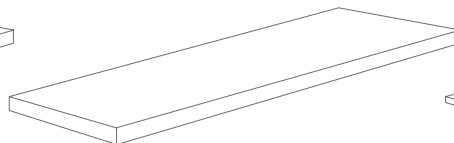

* angolare CR SX 33,3x120 (13"x47")
matt rett.

- 7688255 forte matt rett.
- 7688265 pietrasanta matt rett.
- 7648197 camaiore matt rett.
- 7651147 lasa matt rett
- 7600245 grafite matt rett.
- 7600240 markina matt rett.
- 7601912 baltic grey matt rett.

148 ▲ 2 ◻

lucido rett.

- 7688315 forte lucido rett.
- 7688325 pietrasanta lucido rett.
- 7648187 camaiore lucido rett.
- 7651157 lasa lucido rett
- 7688599 portovenere lucido rett.
- 7600208 grafite lucido rett.
- 7601160 markina lucido rett.
- 7601902 baltic grey lucido rett.

150 ▲ 2 ◻

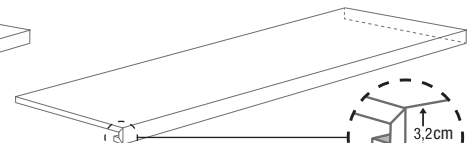

angolare CR DX 33,3x120 (13"x47")
matt rett.

- 7688225 forte matt rett.
- 7688235 pietrasanta matt rett.
- 7648198 camaiore matt rett.
- 7651146 lasa matt rett
- 7600246 grafite matt rett.
- 7601259 markina matt rett.
- 7601911 baltic grey matt rett.

148 ▲ 2 ◻



lucido rett.

- 7688285 forte lucido rett.
- 7688295 pietrasanta lucido rett.
- 7648189 camaiore lucido rett.
- 7651156 lasa lucido rett
- 7688600 portovenere lucido rett.
- 7600209 grafite lucido rett.
- 7601159 markina lucido rett.
- 7601901 baltic grey lucido rett.

150 ▲ 2 ◻

IMBALLI packing - emballages - verpackung - УПАКОВКА

TILE+	F.TO NOMINALE / NOMINAL SIZE	mm.	TIPOLOGIA IMBALLO / PACKAGING		LASTRA / SLAB			CASSA - CAVALLETTI / CRATE - A-FRAME					
			ARTICOLO / ITEM	DIMENSIONE / SIZE	PCS	M2	KG	PCS	M2	KG VUOTO/EMPTY	KG TOT		
	120x260	rett.	6,5	1 cassa / crate	136x284	1	3,12	49,92	20	62,40	95	1093	
	90x270	rett.	6		106x297	1	2,43	38	22	53,46	93	929	
	90x90	rett.	6		94x124	3	2,43	12,66	78	63,10	14	1001,5	
	45x90	rett.	6		pallet con sponda	94x124	5	2,025	6,08	150	60,75	14	926
	30x90	rett.	6		100x120	6	1,62	4,15	180	48,60	14	761	

TILE+	F.TO NOMINALE / NOMINAL SIZE	mm.	TIPOLOGIA IMBALLO / PACKAGING							
			ARTICOLO / ITEM	DIMENSIONE / SIZE	PCS / BOX	M2 / BOX	BOX / PLT	M2 / PLT	KG. / PLT	
	120x120	rett.	6,5	pallet con sponda	123x143	2	2,88	24	69,12	1106
	60x120	rett.	6,5	pallet	95x122	3	2,16	36	77,76	1244

F.TO NOMINALE / NOMINAL SIZE	mm.	PCS / BOX	M2 / BOX	BOX / PLT	M2 / PLT	KG. / PLT
90x180 rett.	10	1	1,62	30	48,60	1215
60x120 rett.	9	2	1,39	36	50,04	1152
60x60 rett.	9	3	1,044	40	41,76	960
30x60 rett.	9	7	1,22	36	43,92	900
30x30 mosaico 5x5	9	11	1,00	-	-	-
30x30 mosaico class	9	11	1,00	-	-	-
32x32 mosaico intreccio	9	11	1,126	-	-	-

¹ Per casse complete con un unico articolo la cassa viene fornita gratuita. Per vendite inferiori alla cassa completa la cassa viene addebitata al costo di € 70,00

If a crate is complete and contains one single item the crate is supplied free of charge. If a crate is not complete the crate is charged at a cost of €70.00

Bei kompletten Kisten, die einen einzigen Artikel enthalten, wird die Kiste nicht berechnet. Bei Verkäufen nicht kompletter Kisten werden die Kisten zum Preis von € 70,00 berechnet.

Pour des caisses remplies avec un seul article, celles-ci seront fournies gratuitement. Pour des ventes qui ne remplissent pas la caisse, celle-ci est vendue à un prix de 70,00 €

Ящики, заполненные полностью одним артикулом, поставляются бесплатно. При продаже количества меньше одного полного ящика взимается плата в размере 70,00 € за ящик

cave roc | marble effect



saime

floor indoor: cave forte rett. 60x60 (24"x24")
floor outdoor: cave roc forte rett. 60x60 (24"x24")
wall outdoor: alpi beige rett. 20x120 (8"x48")

cave roc

pietrasanta roc



formati modulari

≠9

60x60 (24"x24")
rett. 82 ●
 8600038 pietrasanta roc rett.
 8600028 forte roc rett.

≠9

30x60 (12"x24")
rett. 82 ●
 8600037 pietrasanta roc rett.
 8600027 forte roc rett.

mosaico 5x5 (2"x2") 124 ●

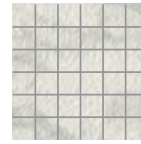

30x30 (12"x12")
 7694215 pietrasanta roc

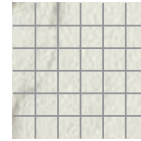

30x30 (12"x12")
 7694225 forte roc

forte roc



PEZZI SPECIALI

trims - pieces speciales
 formstücke - СОБЫЕЭЛЕМЕНТЫ

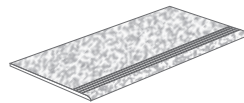

gradino step rett.
30x60 (12"x24")
 8600036 pietrasanta roc rett.
 8600026 forte roc rett.
 48 ▲ 7 ▢



POSA 1/4



FUGA >3 mm



DIN 51130
 R11



DIN 51097
 A+B+C

cave roc | marble effect

IMBALLI packing - emballages - verpackung - УПАКОВКА

F.TO NOMINALE / NOMINAL SIZE	mm.	PCS / BOX	M2 / BOX	BOX / PLT	M2 / PLT	KG. / PLT
60x60 rett.	9	3	1,08	40	43,20	900
30x60 rett.	9	7	1,26	40	50,40	1120
30x30 mosaico	9	11	1	-	-	-

effetto marmo

bianco



30x60 (12"x24")
naturale non rett. 68 ●
 7675451 bianco nat.
 7675471 perla nat.
 7675491 nero nat.

perla



29,7x59,5 (12"x24")
lappato rett. 86 ●
 7675671 bianco lapp. rett.
 7675691 perla lapp. rett.
 7675711 nero lapp. rett.

nero



brick 3x10 (1,2"x4")



30x30 (12"x12")
 7677181 bianco lapp. 129 ●



30x30 (12"x12")
 7677271 perla lapp. 129 ●



30x30 (12"x12")
 7677261 nero lapp. 129 ●

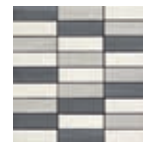

30x30 (12"x12")
 7677281 mix
 bi/pe/ne lapp. 129 ●

2 FINITURE

finishes - surfaces
 Oberfläche - ПОВЕРХНОСТИ

Naturale

Lappato

GM

V2



POSA 1/4



FUGA 2 mm
 PER RETT.



FUGA >3 mm
 PER NON RETT.

PEZZI SPECIALI

trims
 pieces speciales
 formstücke
 СОБЫЕЭЛЕМЕНТЫ

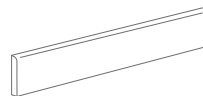

battiscopa lappato rett.
7,5x29,7 (3"x24")
 7677301 bianco lapp. rett.
 7677331 perla lapp. rett.
 7677321 nero lapp. rett.
 12 ▲ 32 ▢

IMBALLI packing - emballages - verpackung - УПАКОВКА

F.TO NOMINALE / NOMINAL SIZE	mm.	PCS / BOX	M2 / BOX	BOX / PLT	M2 / PLT	KG. / PLT
30x60 non rett.	9	7	1,26	40	50,4	989
29,7x59,5 rett.	9	7	1,24	40	49,6	1000
30x30 brick	9	11	1,00	-	-	-

shine | marble effect

shine

COLORI

colours - couleurs
farbe - ЦВЕТА

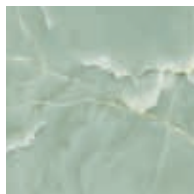

acquamarina

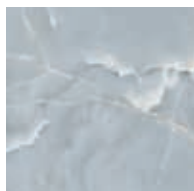

azzurro



crema

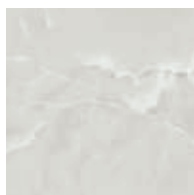

bianco

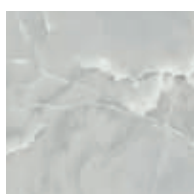

perla

FORMATI TILE+

sizes - formats
format - ФОРМАТЫ

formati modulari

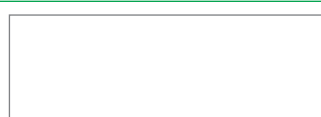

90x270 (36"x106") RETT. #6



90x90 (36"x36") RETT. #6



45x90 (18"x36") RETT. #6



30x90 (12"x36") RETT. #6

FORMATI standard

sizes - formats
format - ФОРМАТЫ

formati modulari



60x120 (24"x47") RETT. #9



60x60 (24"x24") RETT. #9



30x60 (12"x24") RETT. #9

2 FINITURE

finishes - surfaces
Oberfläche - ПОВЕРХНОСТИ

Matt

Lucido

GM

V3



POSA 1/4



FUGA 2 mm
PER RETT.

shine | marble effect

acquamarina



shine TILE+



90x270 (36"x106")
 T624006 matt rett. 107 ●
 T624106 lucido rett. 115 ●



90x90 (36"x36")
 T624008 matt rett. 94 ●
 T624108 lucido rett. 111 ●



45x90 (18"x36")
 T624007 matt rett. 94 ●
 T624107 lucido rett. 111 ●



30x90 (12"x36")
 T624009 matt rett. 94 ●
 T624109 lucido rett. 111 ●

shine standard



60x120 (24"x47")
 8660005 matt rett. 88 ●
 8660105 lucido rett. 103 ●



60x60 (24"x24")
 8660006 matt rett. 82 ●
 8660106 lucido rett. 95 ●



30x60 (12"x24")
 8660007 matt rett. 82 ●
 8660107 lucido rett. 95 ●

azzurro



shine TILE+



90x270 (36"x106")
 T624016 matt rett. 107 ●
 T624116 lucido rett. 115 ●



90x90 (36"x36")
 T624018 matt rett. 94 ●
 T624118 lucido rett. 111 ●



45x90 (18"x36")
 T624017 matt rett. 94 ●
 T624117 lucido rett. 111 ●



30x90 (12"x36")
 T624019 matt rett. 94 ●
 T624119 lucido rett. 111 ●

shine standard



60x120 (24"x47")
 8660015 matt rett. 88 ●
 8660115 lucido rett. 103 ●



60x60 (24"x24")
 8660016 matt rett. 82 ●
 8660116 lucido rett. 95 ●



30x60 (12"x24")
 8660017 matt rett. 82 ●
 8660117 lucido rett. 95 ●

shine | marble effect

crema



shine TILE+



90x270 (36"x106")
 T624036 matt rett. 107 ●
 T624136 lucido rett. 115 ●



90x90 (36"x36")
 T624038 matt rett. 94 ●
 T624138 lucido rett. 111 ●



45x90 (18"x36")
 T624037 matt rett. 94 ●
 T624137 lucido rett. 111 ●



30x90 (12"x36")
 T624039 matt rett. 94 ●
 T624139 lucido rett. 111 ●

shine standard



60x120 (24"x47")
 8660045 matt rett. 88 ●
 8660145 lucido rett. 103 ●



60x60 (24"x24")
 8660046 matt rett. 82 ●
 7660146 lucido rett. 95 ●



30x60 (12"x24")
 8660047 matt rett. 82 ●
 8660147 lucido rett. 95 ●

bianco



shine TILE+



90x270 (36"x106")
 T624026 matt rett. 107 ●
 T624126 lucido rett. 115 ●



90x90 (36"x36")
 T624028 matt rett. 94 ●
 T624128 lucido rett. 111 ●



45x90 (18"x36")
 T624027 matt rett. 94 ●
 T624127 lucido rett. 111 ●



30x90 (12"x36")
 T624029 matt rett. 94 ●
 T624129 lucido rett. 111 ●

shine standard



60x120 (24"x47")
 8660035 matt rett. 88 ●
 8660135 lucido rett. 103 ●



60x60 (24"x24")
 8660036 matt rett. 82 ●
 8660136 lucido rett. 95 ●



30x60 (12"x24")
 8660037 matt rett. 82 ●
 8660137 lucido rett. 95 ●

shine | marble effect

perla



shine TILE+



90x270 (36"x106")
 T624046 matt rett. 107 ●
 T624146 lucido rett. 115 ●



90x90 (36"x36")
 T624048 matt rett. 94 ●
 T624148 lucido rett. 111 ●



45x90 (18"x36")
 T624047 matt rett. 94 ●
 T624147 lucido rett. 111 ●



30x90 (12"x36")
 T624049 matt rett. 94 ●
 T624149 lucido rett. 111 ●

shine standard



60x120 (24"x47")
 8660025 matt rett. 88 ●
 8660125 lucido rett. 103 ●



60x60 (24"x24")
 8660026 matt rett. 82 ●
 8660126 lucido rett. 95 ●



30x60 (12"x24")
 8660027 matt rett. 82 ●
 8660127 lucido rett. 95 ●

PEZZI SPECIALI trims - pieces speciales - formstücke - СОБЫЕЭЛЕМЕНТЫ

shine

TILE+ #6



battiscopa 7,5x90 (3"x36")
matt rett.

T624010 acquamarina matt rett.
T624020 azzurro matt rett.
T624040 crema matt rett.
T624030 bianco matt rett.
T624050 perla matt rett.

40 ▲ 5 ◻



battiscopa 7,5x90 (3"x36")
lucido rett.

T624110 acquamarina lucido rett.
T624120 azzurro lucido rett.
T624140 crema lucido rett.
T624130 bianco lucido rett.
T624150 perla lucido rett.

43 ▲ 5 ◻

shine

standard #9

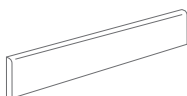

battiscopa 7,5x60 (3"x24")
matt rett.

8660008 acquamarina matt rett.
8660018 azzurro matt rett.
8660048 crema matt rett.
8660038 bianco matt rett.
8660028 perla matt rett.

24 ▲ 14 ◻

lucido rett.

8660108 acquamarina lucido rett.
8660118 azzurro lucido rett.
8660148 crema lucido rett.
8660138 bianco lucido rett.
8660128 perla lucido rett.

28 ▲ 14 ◻

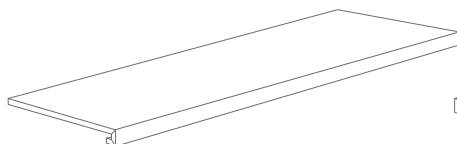

* gradone CR 33,3x120 (13"x47")
matt rett.

8660011 acquamarina matt rett.
8660021 azzurro matt rett.
8660051 crema matt rett.
8660041 bianco matt rett.
8660031 perla matt rett.

141 ▲ 2 ◻

lucido rett.

8660111 acquamarina lucido rett.
8660121 azzurro lucido rett.
8660151 crema lucido rett.
8660141 bianco lucido rett.
8660131 perla lucido rett.

145 ▲ 2 ◻

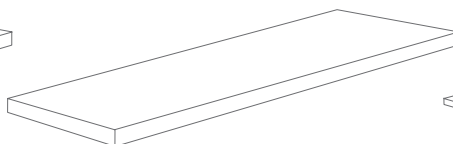

* angolare CR SX 33,3x120 (13"x47")
matt rett.

8660010 acquamarina matt rett.
8660020 azzurro matt rett.
8660050 crema matt rett.
8660040 bianco matt rett.
8660030 perla matt rett.

148 ▲ 2 ◻

lucido rett.

8660110 acquamarina lucido rett.
8660120 azzurro lucido rett.
8660150 crema lucido rett.
8660140 bianco lucido rett.
8660130 perla lucido rett.

150 ▲ 2 ◻

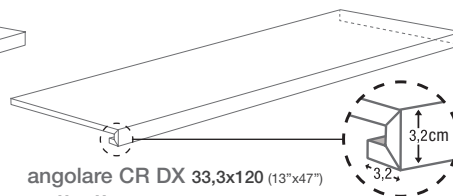

angolare CR DX 33,3x120 (13"x47")
matt rett.

8660009 acquamarina matt rett.
8660019 azzurro matt rett.
8660049 crema matt rett.
8660039 bianco matt rett.
8660029 perla matt rett.

148 ▲ 2 ◻

lucido rett.

9660109 acquamarina lucido rett.
8660119 azzurro lucido rett.
8660149 crema lucido rett.
8660139 bianco lucido rett.
8660129 perla lucido rett.

150 ▲ 2 ◻

IMBALLI packing - emballages - verpackung - УПАКОВКА

TILE+		mm.	TIPOLOGIA IMBALLO / PACKAGING		LASTRA / SLAB			CASSA - CAVALLETTO / CRATE - A-FRAME			
F.TO NOMINALE / NOMINAL SIZE			ARTICOLO / ITEM	DIMENSIONE / SIZE	PCS	M2	KG	PCS	M2	KG VUOTO/EMPTY	KG TOT
90x270	rett.	6	1 cassa / crate 	106x297	1	2,43	38	22	53,46	93	929
90x90	rett.	6	pallet con sponda	94x124	3	2,43	12,66	78	63,10	14	1001,5
45x90	rett.	6		94x124	5	2,025	6,08	150	60,75	14	926
30x90	rett.	6		100x120	6	1,62	4,15	180	48,60	14	761

STANDARD		mm.	PCS / BOX	M2 / BOX	BOX / PLT	M2 / PLT	KG. / PLT
F.TO NOMINALE / NOMINAL SIZE							
60x120	rett.	9	2	1,44	36	51,84	1170
60x60	rett.	9	3	1,080	40	43,20	900
30x60	rett.	9	7	1,26	40	50,40	1120
30x60	non rett.	9	7	1,26	40	50,40	989,20

* Per casse complete con un unico articolo la cassa viene fornita gratuita. Per vendite inferiori alla cassa completa la cassa viene addebitata al costo di € 70,00

If a crate is complete and contains one single item the crate is supplied free of charge. If a crate is not complete the crate is charged at a cost of €70.00

Bei kompletten Kisten, die einen einzigen Artikel enthalten, wird die Kiste nicht berechnet. Bei Verkäufen nicht kompletter Kisten werden die Kisten zum Preis von € 70,00 berechnet.

Pour des caisses remplies avec un seul article, celles-ci seront fournies gratuitement. Pour des ventes qui ne remplissent pas la caisse, celle-ci est vendue à un prix de 70,00 €

Ящики, заполненные полностью одним артикулом, поставляются бесплатно. При продаже количества меньше одного полного ящика взимается плата в размере 70,00 € за ящик

shine

shine | marble effect

collections 2021

04

wood effect

effetto legno / imitation boi
Holzoptik / Дерево

alpi	222
painted	228
tundra	230

alpi | wood effect

COLORI

colours - couleurs - farbe - ЦВЕТА



bianco



beige

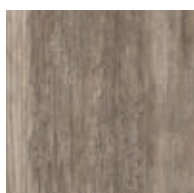

tortora

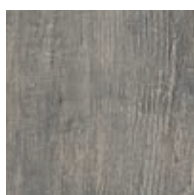

grigio

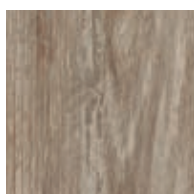

avana



miele

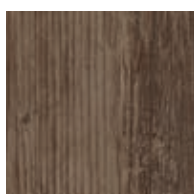

tabacco

FORMATI

sizes - formats - format - ФОРМАТЫ

naturale



30x120 (12"x47") RETT. #9



20x120 (8"x47") RETT. #9



15x90 (6"x36") NON RETT. #8,5

grip



20x120 (8"x47") RETT. #9



15x90 (6"x36") NON RETT. #8

> pag. 246

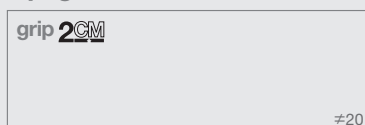

40x120 (16"x47") RETT. #20

2 FINITURE

finishes - surfaces
Oberfläche - ПОВЕРХНОСТИ

Naturale

Grip



POSA 1/4



FUGA 2 mm
PER RETT.



FUGA >3 mm
PER NON RETT.



DIN 51130
R11 (GRIP)



DIN 51097
A+B+C (GRIP)

alpi | wood effect

bianco



grigio



beige



tortora



naturale



30x120 (12"x47")
rett.

86 ●

8600328 bianco rett.
8600327 beige rett.
8600325 grigio rett.
8600355 tortora rett.
8600385 miele rett.
8600329 tabacco rett.
8600326 avana rett.



20x120 (8"x47")
rett.

86 ●

8600318 bianco rett.
8600317 beige rett.
8600315 grigio rett.
8600345 tortora rett.
8600375 miele rett.
8600319 tabacco rett.
8600316 avana rett.



15x90 (6"x36")
non rett.

74 ●

7670149 bianco
7670159 beige
7670179 grigio
7670169 tortora
7670189 miele
7670249 tabacco

grip



20x120 (8"x47")
grip rett.

86 ●

8600408 bianco grip rett.
8600407 beige grip rett.
8600409 grigio grip rett.
8600412 tortora grip rett.
8600405 miele grip rett.
8600411 tabacco grip rett.
8600406 avana grip rett.

grip



15x90 (6"x36")
grip non rett.

74 ●

7670199 bianco grip
7670209 beige grip
7670229 grigio grip
7670219 tortora grip
7670239 miele grip
7670259 tabacco grip

miele



tabacco



avana



alpi | wood effect



miele rett. 30x120 (12"x47")

PEZZI SPECIALI trims - pieces speciales - formstücke - СОБЫЕЭЛЕМЕНТЫ

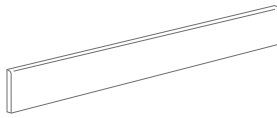

battiscopa

7,5x90 (3"x36")

7670150 bianco
7670160 beige
7670180 grigio
7670170 tortora
7670190 miele
7670250 tabacco

40 ▲ 5 ◻

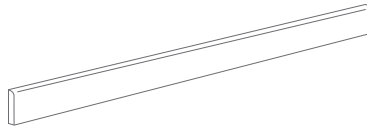

battiscopa rett.

6,5x120 (2,56"x47")

8601328 bianco rett.
8601327 beige rett.
8601325 grigio rett.
8601355 tortora rett.
8601326 avana rett.
8601385 miele rett.
8601329 tabacco rett.

48 ▲ 4 ◻

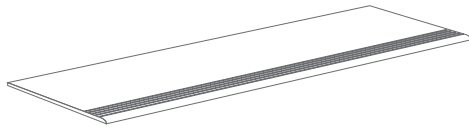

gradino step rett.

30x120 (12"x47")

8600338 bianco rett.
8600337 beige rett.
8600324 grigio rett.
8600349 tortora rett.
8600336 avana rett.
8600384 miele rett.
8600358 tabacco rett.

106 ▲ 4 ◻

alpi | wood effect

IMBALLI packing - emballages - verpackung - УПАКОВКА

F.TO NOMINALE / NOMINAL SIZE	mm.	PCS / BOX	M2 / BOX	BOX / PLT	M2 / PLT	KG. / PLT
30x120 rett.	9	3	1,08	45	48,60	1080
20x120 rett.	9	4	0,96	48	46,08	1032
15x90	8	7	0,945	48	45,36	884,5

alpi

alpi | wood effect

painting | wood effect

Painted

beige



wengé

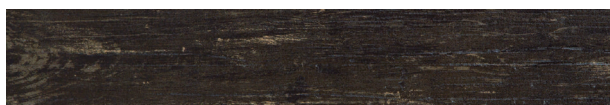

grey



dark



white



≠8

15x90 (6"x36")

naturale non rett. 74 ●

7670019 white nat.
7670039 beige nat.
7670089 wengé nat.
7670029 grey nat.
7670009 dark nat.

grip non rett. 74 ●

7670008 white grip
7670119 beige grip
7670099 wengé grip
7670018 grey grip
7670028 dark grip

2 FINITURE

finishes - surfaces
Oberfläche - ПОВЕРХНОСТИ

Naturale

Grip

GM

V3



POSA 1/4



FUGA >3 mm



DIN 51130
R11 (GRIP)



DIN 51097
A+B+C (GRIP)

Painted | wood effect

PEZZI SPECIALI trims - pieces speciales - formstücke - СОБИЕЭЛЕМЕНТЫ



battiscopa naturale non rett.

8x45 (3"x18")

7670020 white nat.
7670129 beige nat.
7670109 wengé nat.
7670030 grey nat.
7670010 dark nat.

18 ▲ 12 ◻

IMBALLI packing - emballages - verpackung - УПАКОВКА

F.TO NOMINALE / NOMINAL SIZE	mm.	PCS / BOX	M2 / BOX	BOX / PLT	M2 / PLT	KG. / PLT
15x90	8	7	0,945	48	45,36	884,54

tundra | wood effect



tundra

COLORI

colours - couleurs - farbe - ЦВЕТА

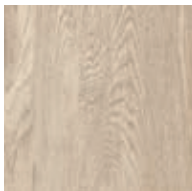

bianco



vaniglia



biondo



terra

FORMATI

sizes - formats - format - ФОРМАТЫ

naturale



20x120 (8"x47") NON RETT.

20x120 (8"x47") RETT.

grip



20x120 (8"x47") NON RETT.

2 FINITURE

finishes - surfaces

Oberfläche - ПОВЕРХНОСТИ

Naturale

Grip

GM

V3



POSA 1/4



FUGA 2 mm
PER RETT.



FUGA >3 mm
PER NON RETT.



DIN 51130
R11 (GRIP)



DIN 51097
A+B+C (GRIP)

tundra | wood effect

bianco



vaniglia



biondo



terra



tundra | wood effect

naturale



20x120 (8"x47")

non rett.

80 ●

- 8697145 bianco nat.
- 8697135 vaniglia nat.
- 8697125 biondo nat.
- 8697115 terra nat.

rett.

86 ●

- 8697195 bianco nat. rett.
- 8697185 vaniglia nat. rett.
- 8697175 biondo nat. rett.
- 8697165 terra nat. rett.

grip



20x120 (8"x47")

grip non rett.

80 ●

- 8697235 bianco grip
- 8697225 vaniglia grip
- 8697215 biondo grip
- 8697205 terra grip

PEZZI SPECIALI trims - pieces speciales - formstücke - СОБИЕЭЛЕМЕНТЫ

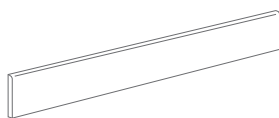

battiscopa rett.

6,5x120 (2,56"x47")

8697196 bianco rett.

8697126 biondo rett.

8697166 terra rett.

8697186 vaniglia rett.

48 ▲ 5 📦

tundra | wood effect

IMBALLI packing - emballages - verpackung - УПАКОВКА

F.TO NOMINALE / NOMINAL SIZE	mm.	PCS / BOX	M2 / BOX	BOX / PLT	M2 / PLT	KG. / PLT
20x120 rett.	9	4	0,96	45	43,2	1080

collections 2021

05

color effect

effetto colore / gamme couleur
Unifarben / Цветовой эффект

i colori | 236

i colori | color effect

wall: i colori+ salvia rett. 90x270 (36"x106")
floor: icon+ ash rett. 90x90 (36"x36")
desk: cave+ forte lucido 90x270 (36"x106")

i colori

COLORI

colours - couleurs - farbe - ЦВЕТА



neve

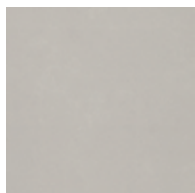

perla



acqua



salvia

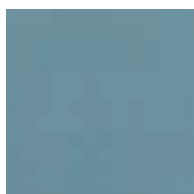

avio



petrolio



bosco



corallo

FORMATI

sizes - formats - format - ФОРМАТЫ

formati modulari



90x270 (36"x106") RETT. #6



90x90 (36"x36") RETT. #6



45x90 (18"x36") RETT. #6

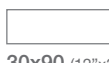

30x90 (12"x36") RETT. #6

GS

V1



POSA 1/4



FUGA 2 mm
PER RETT.

i colori | color effect

neve

perla

i colori | color effect



90x270 (36"x106")
T622805 neve matt rett.
T622735 perla matt rett.

107 ●



90x90 (36"x36")
T622965 neve matt rett.
T622895 perla matt rett.

94 ●



45x90 (18"x36")
T623045 neve matt rett.
T622975 perla matt rett.

94 ●



30x90 (12"x36")
T623125 neve matt rett.
T623055 perla matt rett.

94 ●

mosaico 30x30 (12"x12")
5x5 (2"x2") 131 ●

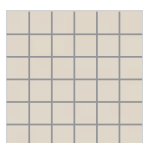

30x30 (12"x12")
T622966 neve matt rett.

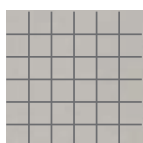

30x30 (12"x12")
T622816 perla matt rett.

muretto 30x30 (12"x12")
5x15 (2"x6") 131 ●

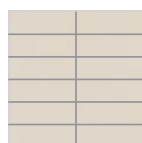

30x30 (12"x12")
T622967 neve matt rett.

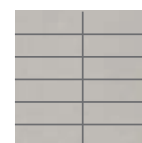

30x30 (12"x12")
T622817 perla matt rett.

acqua

salvia

i colori
TILE+



i colori | color effect



90x270 (36"x106") 107 ● ≠6
T622755 acqua matt rett.
T622775 salvia matt rett.



90x90 (36"x36") 94 ● ≠6
T622915 acqua matt rett.
T622935 salvia matt rett.



45x90 (18"x36") 94 ● ≠6
T622995 acqua matt rett.
T623015 salvia matt rett.



30x90 (12"x36") 94 ● ≠6
T623075 acqua matt rett.
T623095 salvia matt rett.

mosaico 30x30 (12"x12") 5x5 (2"x2") 131 ●

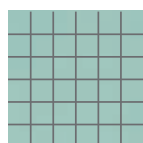

30x30 (12"x12")
T622916 acqua matt rett.

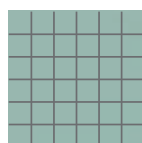

30x30 (12"x12")
T622936 salvia matt rett.

muretto 30x30 (12"x12") 5x15 (2"x6") 131 ●

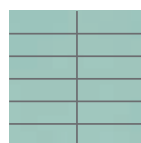

30x30 (12"x12")
T622917 acqua matt rett.

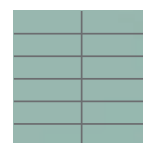

30x30 (12"x12")
T622937 salvia matt rett.

avio

petrolio

i colori | color effect

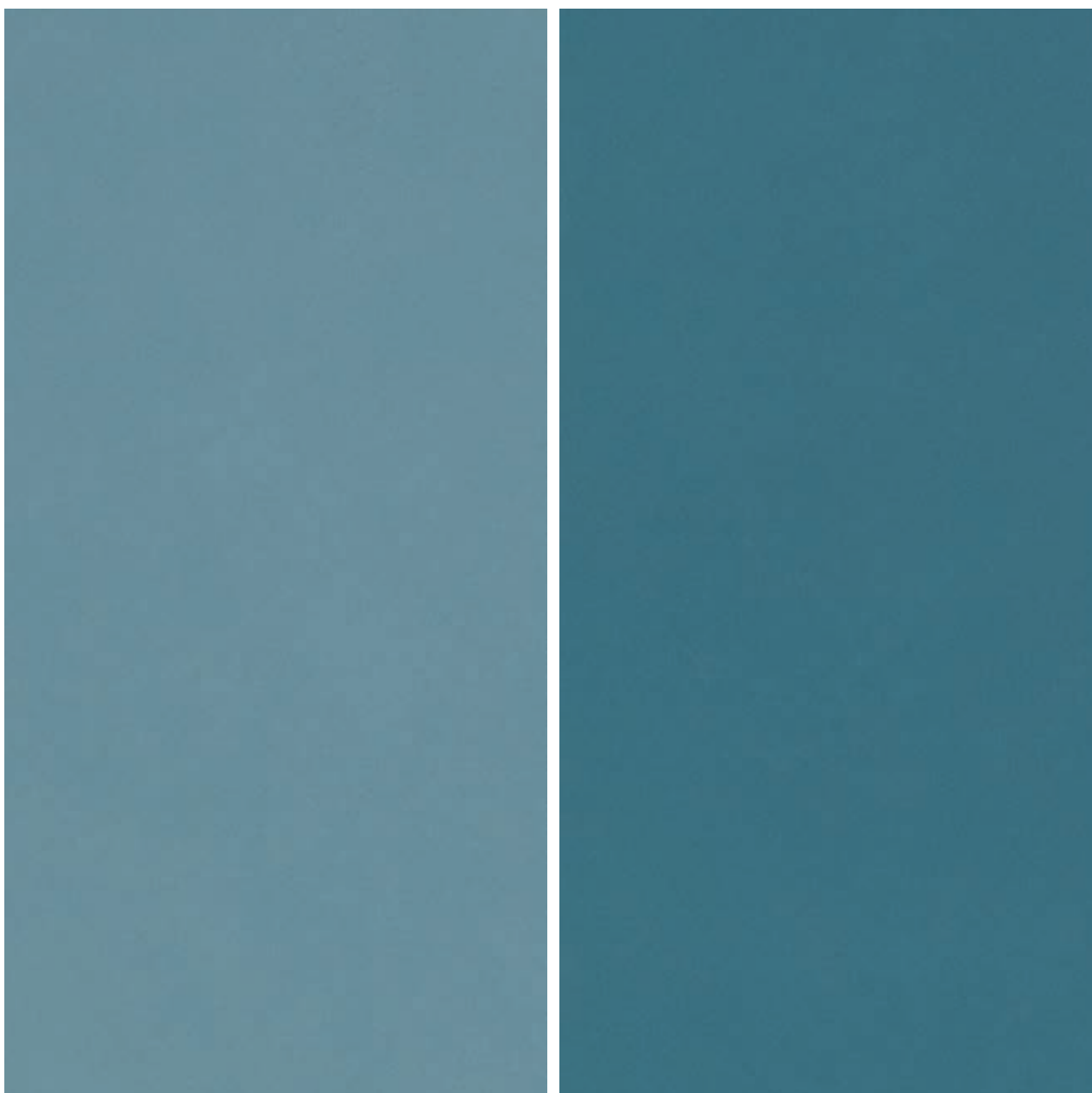

90x270 (36"x106")

107 ●

T622765 avio matt rett.
T622785 petrolio matt rett.



90x90 (36"x36")

94 ●

T622925 avio matt rett.
T622945 petrolio matt rett.



45x90 (18"x36")

94 ●

T623005 avio matt rett.
T623025 petrolio matt rett.



30x90 (12"x36")

94 ●

T623085 avio matt rett.
T623105 petrolio matt rett.

mosaico 30x30 (12"x12")

5x5 (2"x2") 131 ●

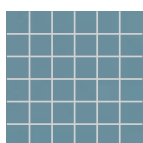

30x30 (12"x12")

T622926 avio matt rett.

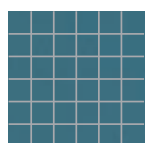

30x30 (12"x12")

T622946 petrolio matt rett.

muretto 30x30 (12"x12")

5x15 (2"x6") 131 ●

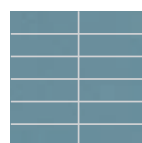

30x30 (12"x12")

T622927 avio matt rett.

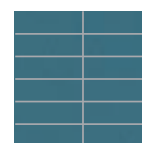

30x30 (12"x12")

T622947 petrolio matt rett.

bosco

corallo

i colori
TILE+

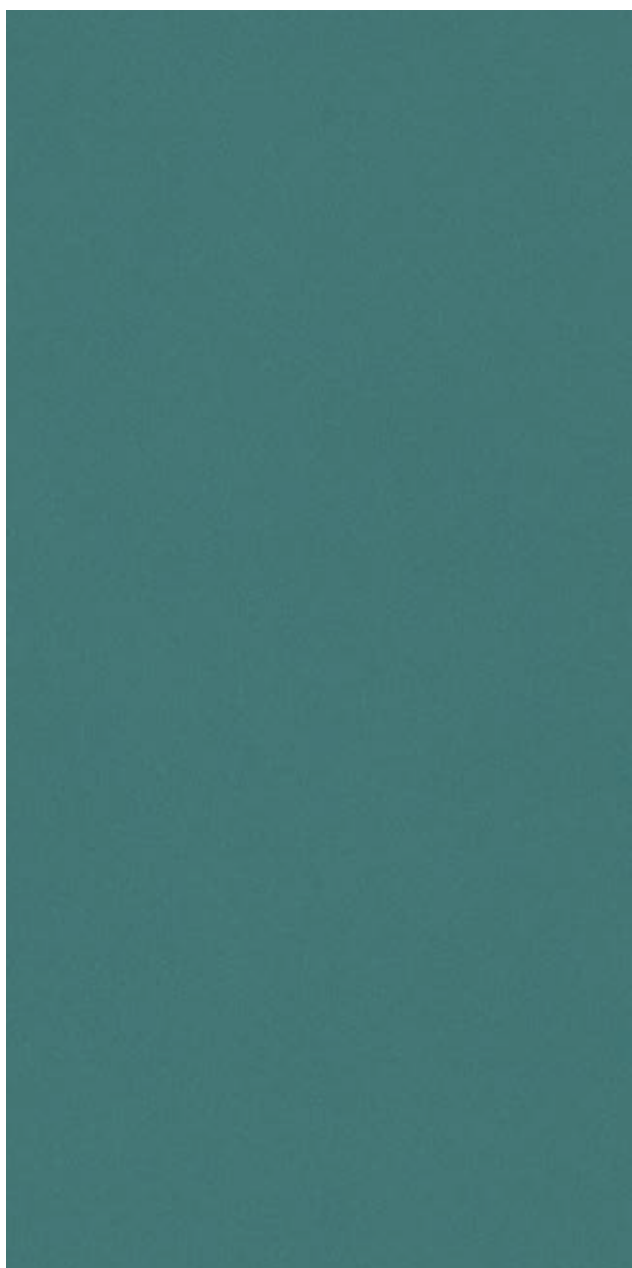

i colori | color effect



90x270 (36"x106") 107 ●
T622795 bosco matt rett.
T622745 corallo matt rett.



90x90 (36"x36") 94 ●
T622955 bosco matt rett.
T622905 corallo matt rett.



45x90 (18"x36") 94 ●
T623035 bosco matt rett.
T622985 corallo matt rett.



30x90 (12"x36") 94 ●
T623115 bosco matt rett.
T623065 corallo matt rett.

mosaico 30x30 (12"x12") 5x5 (2"x2") 131 ●

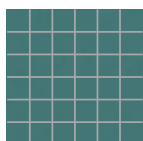

30x30 (12"x12")
T622956 bosco matt rett.

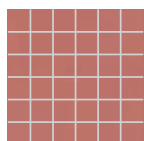

30x30 (12"x12")
T622906 corallo matt rett.

muretto 30x30 (12"x12") 5x15 (2"x6") 131 ●

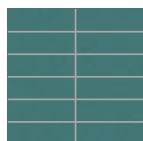

30x30 (12"x12")
T622957 bosco matt rett.

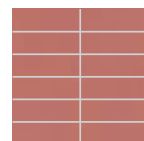

30x30 (12"x12")
T622907 corallo matt rett.



wall: i colori avio matt 90x270 (36"x106"), 90x90 (36"x36"), perla matt 90x270 (36"x106"), 90x90 (36"x36")
 floor: frammenta perla luc. 60x120 (24"x47")

IMBALLI packing - emballages - verpackung - УПАКОВКА

TILE+	F.TO NOMINALE / NOMINAL SIZE	mm.	TIPOLOGIA IMBALLO / PACKAGING		LASTRA / SLAB			CASSA - CAVALLETTO / CRATE - A-FRAME			
			ARTICOLO / ITEM	DIMENSIONE / SIZE	PCS	M2	KG	PCS	M2	KG VUOTO/EMPTY	KG TOT
			1 cassa / crate								
90x270	rett.	6		106x297	1	2,43	38	22	53,46	93	929
90x90	rett.	6		94x124	3	2,43	12,66	78	63,10	14	1001,5
45x90	rett.	6	pallet con sponda	94x124	5	2,025	6,08	150	60,75	14	926
30x90	rett.	6		100x120	6	1,62	4,15	180	48,60	14	761

* Per casse complete con un unico articolo la cassa viene fornita gratuita. Per vendite inferiori alla cassa completa la cassa viene addebitata al costo di € 70,00

If a crate is complete and contains one single item the crate is supplied free of charge. If a crate is not complete the crate is charged at a cost of €70.00

Bei kompletten Kisten, die einen einzigen Artikel enthalten, wird die Kiste nicht berechnet. Bei Verkäufen nicht kompletter Kisten werden die Kisten zum Preis von € 70,00 berechnet.

Pour des caisses remplies avec un seul article, celles-ci seront fournies gratuitement. Pour des ventes qui ne remplissent pas la caisse, celle-ci est vendue à un prix de 70,00 €

Ящики, заполненные полностью одним артикулом, поставляются бесплатно. При продаже количества меньше одного полного ящика взимается плата в размере 70,00 € за ящик

i colori
TILE+

i colori | color effect

wall: i colori acqua matt 45x90 (18"x36"), neve muretto 30x30 (12"x12")
floor: icon+ grey matt 90x90 (36"x36")

saime

collections 2021

06

2CM
outdoor
paving 20mm

alpi grip	246
artica roc	248
frammenta roc	250
icon grip	252
neutra roc	254
titano grip	256
urbandeck grip	258



alpi grip 2CM

PAVIMENTI A SECCO PER ESTERNI
DRY-LAID FLOORING FOR OUTDOOR USE
DALLAGES A SEC POUR EXTERIEURS
TROCKENFUSSBÖDEN FÜR AUSSENÄUME

alpi grip 2CM

avana grip



40x120 (16"x47")
8695027 rett.

102 ●

beige grip



40x120 (16"x47")
8695007 rett.

102 ●

miele grip



40x120 (16"x47")
8695017 rett.

102 ●

GM

V3



DIN 51130
R11



DIN 51097
A+B+C

alpi grip | 2CM

PEZZI SPECIALI trims - pieces speciales - formstücke - СОБЫЕЭЛЕМЕНТЫ

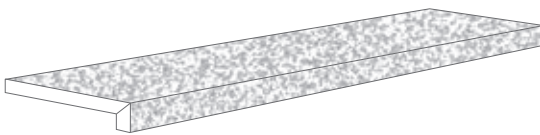

elemento elle rett.

40x120x4 (16"x47"x1,5")
8695028 avana grip rett.
8695008 beige grip rett.
8695018 miele grip rett.

135 ▲ 2 ☐

IMBALLI packing - emballages - verpackung - УПАКОВКА

F.TO NOMINALE / NOMINAL SIZE	mm.	PCS / BOX	M2 / BOX	BOX / PLT	M2 / PLT	KG. / PLT
40x120 Rett.	20	2	0,96	32	30,72	1444

artica roc | 2CM

PAVIMENTI A SECCO PER ESTERNI
DRY-LAID FLOORING FOR OUTDOOR USE
DALLAGES A SEC POUR EXTERIEURS
TROCKENFUSSBÖDEN FÜR AUSSENÄRÄUME

artica roc 2CM

bianco roc



60x60 (24"x24")
7690718 rett. #20
93 ●

nube roc

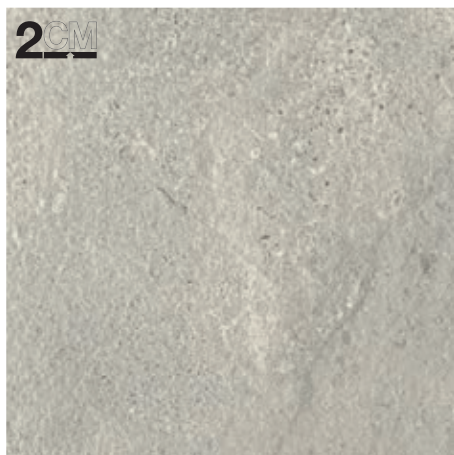

60x60 (24"x24")
7688478 rett. #20
93 ●

GM

V3



DIN 51130
R11



DIN 51097
A+B+C

brandy roc



60x60 (24"x24")
8610005 rett. #20
93 ●

grigio roc

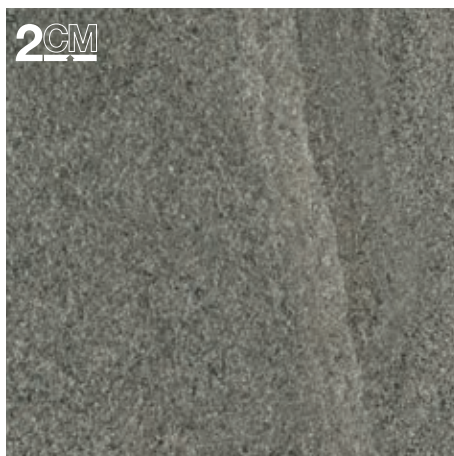

60x60 (24"x24")
8610007 rett. #20
93 ●

PEZZI SPECIALI

trims
pieces speciales
formstücke
СОБЫЕЭЛЕМЕНТЫ

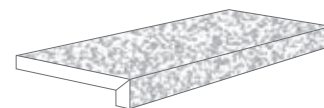

elemento elle rett.

30x60x4 (12"x24"x1.5")
8610006 brandy roc rett.
7688490 grigio roc rett.
7688480 nube roc rett.
7688460 bianco roc rett.
116 ▲ 7 ☐

artica roc | 2CM

2,8 PCS / 1 M2							
SUPPORTI FISSI - FIXED SUPPORTS PLOTS FIXES - FIXE STELZLAGER		SUPPORTI REGOLABILI IN ALTEZZA - SUPPORT WITH ADJUSTABLE HEIGHT PLOTS REGOLABLES EN HAUTEUR - STELZLAGER MIT EINSTELLBARER HÖHE					
H 25 mm 19 ▲ 7327019	H 35-50 mm 24 ▲ 7326979	H 50-70 mm 24 ▲ 7326989	H 65-100 mm 26 ▲ 7326999	H 95-130 mm 28 ▲ 7327009	H 125-160 mm 31 ▲ 7327007	H 155-190 mm 32 ▲ 7327008	H 185-220 mm 34 ▲ 7327018

IMBALLI packing - emballages - verpackung - УПАКОВКА

F.TO NOMINALE / NOMINAL SIZE	mm.	PCS / BOX	M2 / BOX	BOX / PLT	M2 / PLT	KG. / PLT
60x60 Rett.	20	2	0,72	32	23,04	1088

frammenta roc 12CM

frammenta roc 2CM

bianco roc

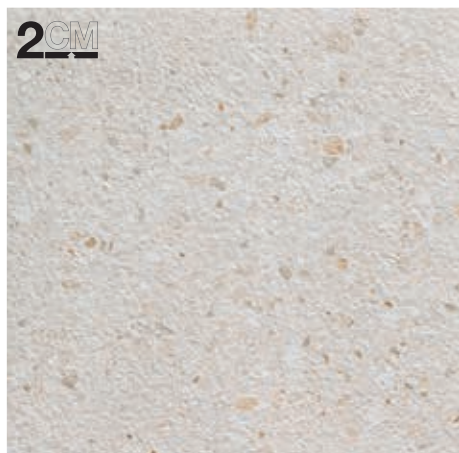

60x60 (24"x24")
8694665 rett. #20
93 ●

perla roc

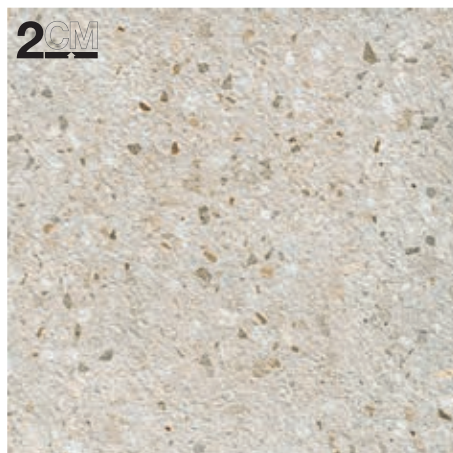

60x60 (24"x24")
8694685 rett. #20
93 ●

GM

V3



DIN 51130
R11



DIN 51097
A+B+C

taupe roc

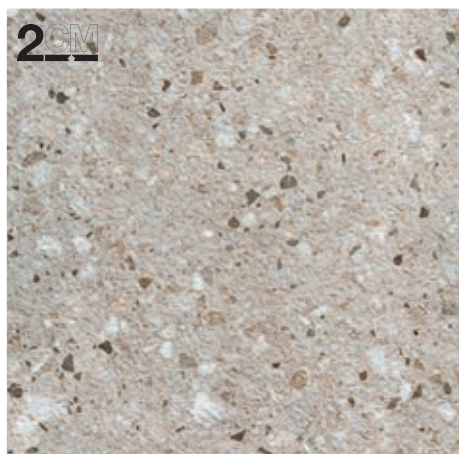

60x60 (24"x24")
8694695 rett. #20
93 ●

grigio roc

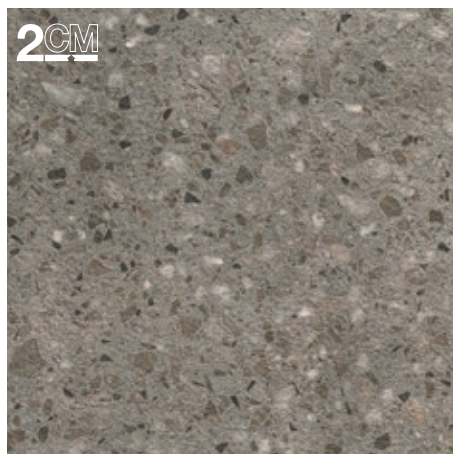

60x60 (24"x24")
8694675 rett. #20
93 ●

frammenta roc | 2CM

PEZZI SPECIALI trims - pieces speciales - formstücke - СОБЫЕЭЛЕМЕНТЫ

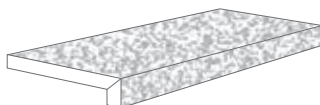

elemento elle rett.
30x60x4 (12"x24"x1,5")
8694666 bianco roc rett.
8694686 perla roc rett.
8694696 taupe roc rett.
8694676 grigio roc rett.
116 ▲ 2 ☐

IMBALLI packing - emballages - verpackung - УПАКОВКА

F.TO NOMINALE / NOMINAL SIZE	mm.	PCS / BOX	M2 / BOX	BOX / PLT	M2 / PLT	KG. / PLT
60x60 Rett.	20	2	0,72	32	23,04	1088



icon grip | 2CM

icon grip 2CM

almond grip



artic grip



DIN 51130
R11



DIN 51097
A+B+C

ash grip

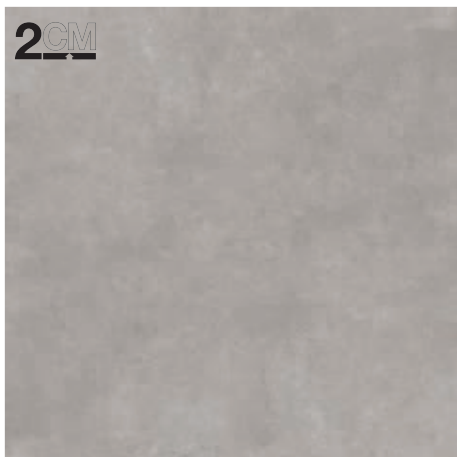

60x120 (24"x47")
7658575 almond rett.
7658555 artic rett.
7658565 ash rett.

104 ●



60x60 (24"x24")
8610015 almond rett.
8610025 artic rett.
8610035 ash rett.

93 ●

PEZZI SPECIALI trims - pieces speciales - formstücke - СОБЫЕЭЛЕМЕНТЫ

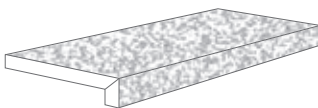

elemento elle rett.
30x60x4 (12"x24"x1,5")
7696006 almond rett.
7696026 ash rett.
7696026 artic rett.
116 ▲ 2 ☐

IMBALLI packing - emballages - verpackung - УПАКОВКА

F.TO NOMINALE / NOMINAL SIZE	mm.	PCS / BOX	M2 / BOX	BOX / PLT	M2 / PLT	KG. / PLT
60x120 Rett.	20	1	0,72	36	25,92	1224
60x60 Rett.	20	2	0,72	32	23,04	1088

neutra roc | 2CM

PAVIMENTI A SECCO PER ESTERNI
DRY-LAID FLOORING FOR OUTDOOR USE
DALLAGES A SEC POUR EXTERIEURS
TROCKENFUSSBÖDEN FÜR AUSSENRAÜME

saime

avorio 60x60 (24"x24")

neutra roc 2CM

avorio roc



60x60 (24"x24")
7685899 rett. ≠20
93 ●

beige roc



60x60 (24"x24")
7685909 rett. ≠20
93 ●

GM

V1



DIN 51130
R11



DIN 51097
A+B+C

piombo roc

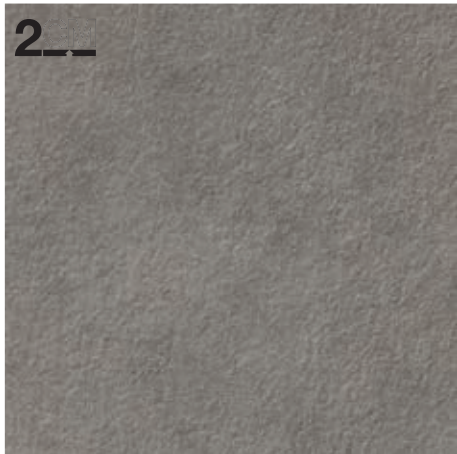

60x60 (24"x24")
7685919 rett. ≠20
93 ●

nero roc



60x60 (24"x24")
7685929 rett. ≠20
93 ●

neutra roc | 2CM

PEZZI SPECIALI trims - pieces speciales - formstücke - СОБЫЕЭЛЕМЕНТЫ

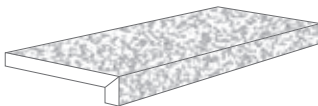

elemento elle rett.
30x60x4 (12"x24"x1,5")
7685896 avorio roc rett.
7685906 beige roc rett.
7685927 nero roc rett.
7685916 piombo roc rett.
116 ▲ 7 ◻

IMBALLI packing - emballages - verpackung - УПАКОВКА

F.TO NOMINALE / NOMINAL SIZE	mm.	PCS / BOX	M2 / BOX	BOX / PLT	M2 / PLT	KG. / PLT
60x60 Rett.	20	2	0,72	32	23,04	1088

titano grip | 2CM

titano grip 2CM

perla grip

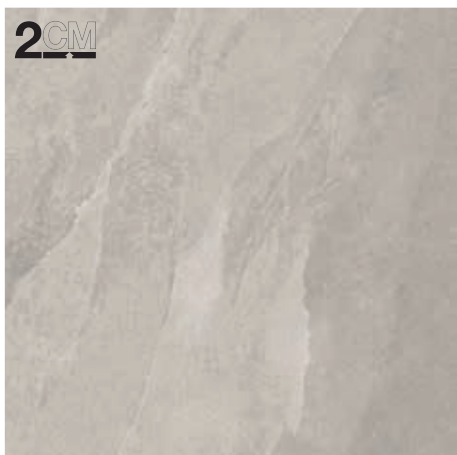

grigio grip

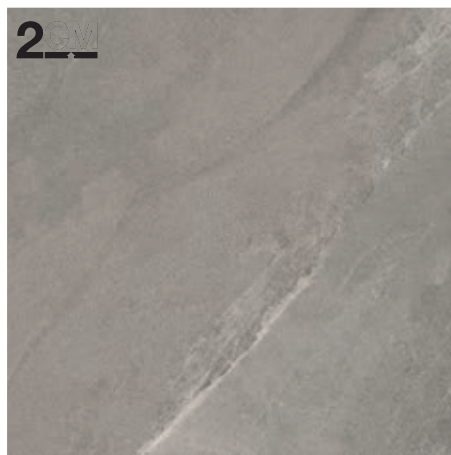

GM

V2



DIN 51130
R11



DIN 51097
A+B+C

beige grip

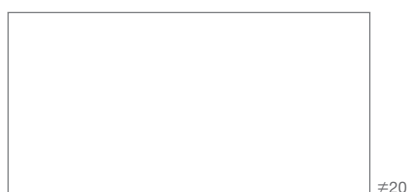

60x120 (24"x47")
8620030 perla rett.
8620020 grigio rett.
8620010 beige rett.

104 ●

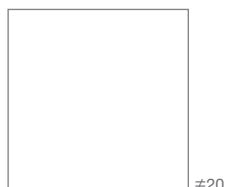

60x60 (24"x24")
8620029 perla rett.
8620019 grigio rett.
8620009 beige rett.

93 ●

PEZZI SPECIALI trims - pieces speciales - formstücke - СОБЫЕЭЛЕМЕНТЫ

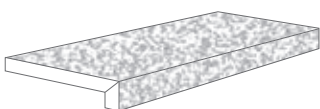

elemento elle rett.

30x60x4 (12"x24"x1,5")
8620031 perla rett.
8620021 grigio rett.
8620011 beige rett.

116 ▲ 2 ◻

IMBALLI packing - emballages - verpackung - УПАКОВКА

F.TO NOMINALE / NOMINAL SIZE	mm.	PCS / BOX	M2 / BOX	BOX / PLT	M2 / PLT	KG. / PLT
60x120 Rett.	20	1	0,72	36	25,92	1224
60x60 Rett.	20	2	0,72	32	23,04	1088

urbandeck grip | 2CM

PAVIMENTI A SECCO PER ESTERNI
DRY-LAID FLOORING FOR OUTDOOR USE
DALLAGES A SEC POUR EXTERIEURS
TROCKENFUSSBÖDEN FÜR AUSSENÄUME

saime

indoor: taupe 60x120 (24"x47") Rett.
outdoor: taupe grip 40x120 (16"x47")

urbandeck grip 2CM

silver grip

grey grip

taupe grip



GM

V3



DIN 51130
R11



DIN 51097
A+B+C

40x120 (16"x47")
8695039 rett. 102 ●

40x120 (16"x47")
8695049 rett. 102 ●

40x120 (16"x47")
8695059 rett. 102 ●

urbandeck grip | 2CM

PEZZI SPECIALI trims - pieces speciales - formstücke - СОБЫЕЭЛЕМЕНТЫ

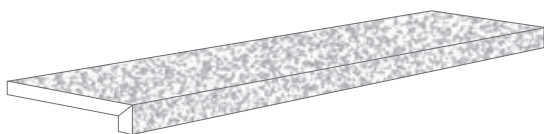

elemento elle rett.
40x120x4 (16"x47"x1,5")
8695038 silver rett.
8695048 grey rett.
8695058 taupe rett.

135 ▲ 2 ◻

IMBALLI packing - emballages - verpackung - УПАКОВКА

F.TO NOMINALE / NOMINAL SIZE	mm.	PCS / BOX	M2 / BOX	BOX / PLT	M2 / PLT	KG. / PLT
40x120 Rett.	20	2	0,96	32	30,72	1444

collections 2021

07

160x320
12 mm 

pietrasanta

forte

grafite

lasa

crystal white

onix ice

ferrocemento grigio

ceppo grigio

timber

basaltina

160x320 #12mm

saima

top: cave+ forte lucido rett. 12mm 160x320 (63"x126")
floor: global+ grey nat. rett. 120x120 (47"x47")

160x320 12mm

COLORI

colours - couleurs - farbe - ЦВЕТА

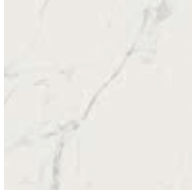

pietrasanta

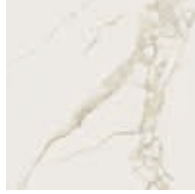

forte

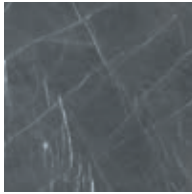

grafite



ceppo grigio



lasa



timber

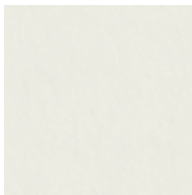

crystal white

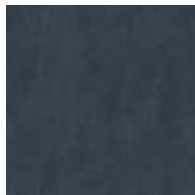

basaltina



ferrocemento
grigio

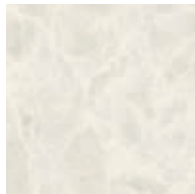

onix ice

FORMATI

sizes - formats - format - ФОРМАТЫ



160x320 (63"x126") NON RETT.

#12

2 FINITURE

finishes - surfaces

Oberfläche - ПОВЕРХНОСТИ

Matt

Naturale

Lucido

160x320 #12mm

pietrasanta bookmatch 160x320 #12

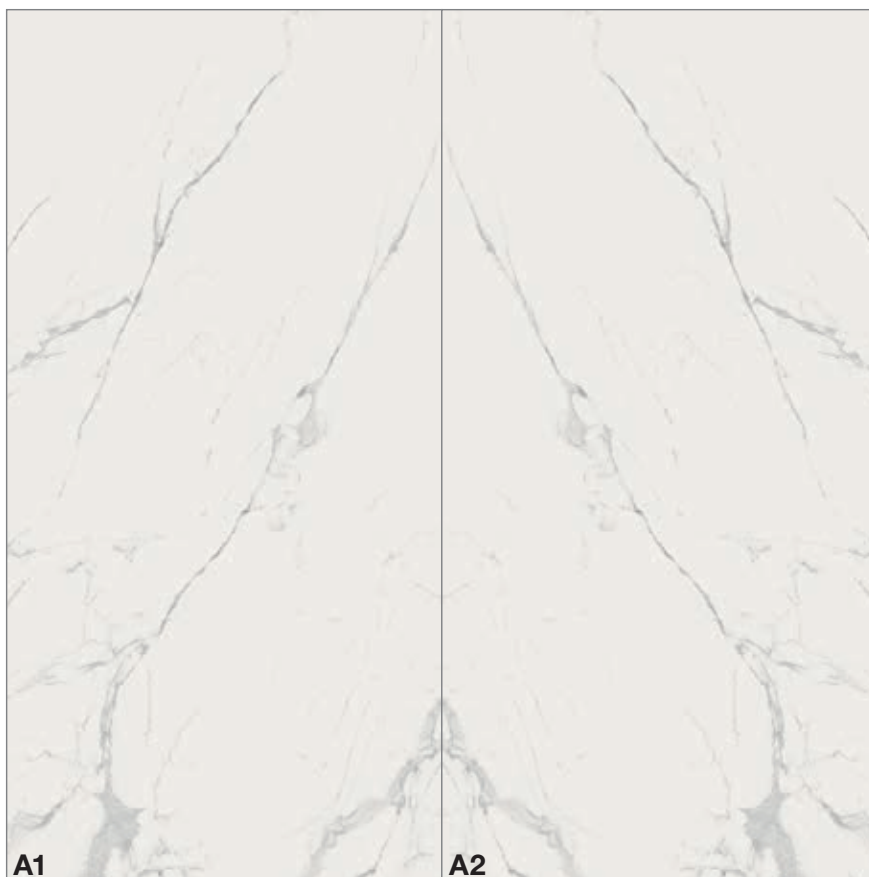

* 160x320 (63"x126")

matt non rett. 134 ●

T616185 A1 matt

T616186 A2 matt

lucido non rett. 137 ●

T616315 A1 lucido

T616316 A2 lucido

* Eventuali differenze grafiche fino a 1,5 cm tra una lastra e l'altra sono da considerarsi caratteristica del prodotto.

LE DUE FACCE A1 E A2 DI 160x320
DEVONO NECESSARIAMENTE
ESSERE ACQUISTATE INSIEME

* Su richiesta possono essere forniti
stuoaiati.

On demand these products are
available also with fiber glass backing.

160x320 #12mm

forte bookmatch 160x320 #12

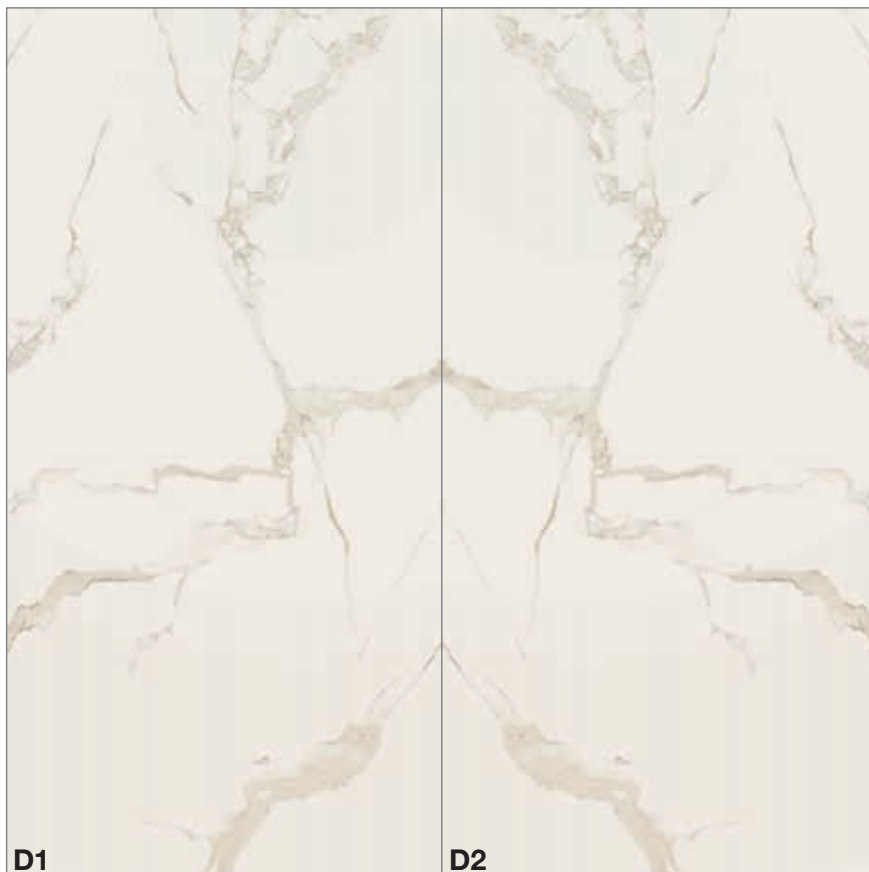

* 160x320 (63"x126")

matt non rett. 134 ●

T616215 D1 matt

T616667 D2 matt

lucido non rett. 137 ●

T616295 D1 lucido

T616666 D2 lucido

* Eventuali differenze grafiche fino a 1,5 cm tra una lastra e l'altra sono da considerarsi caratteristica del prodotto.

LE DUE FACCE A1 E A2 DI 160x320
DEVONO NECESSARIAMENTE
ESSERE ACQUISTATE INSIEME

* Su richiesta possono essere forniti
stuoaiati.

On demand these products are
available also with fiber glass backing.

basaltina



lasa



160x320 12mm

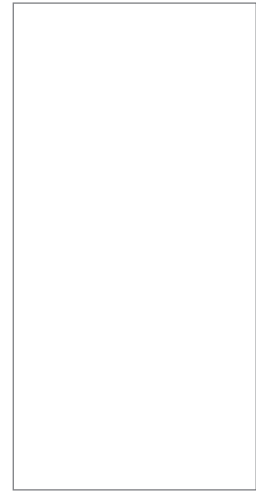

#12

* 160x320 (63"x126")

matt non rett. 134 ●

T616575 lasa

T901845 basaltina

lucido non rett. 137 ●

T616275 lasa

T616335 crystal white

T616355 onix ice

160x320 #12mm

crystal white

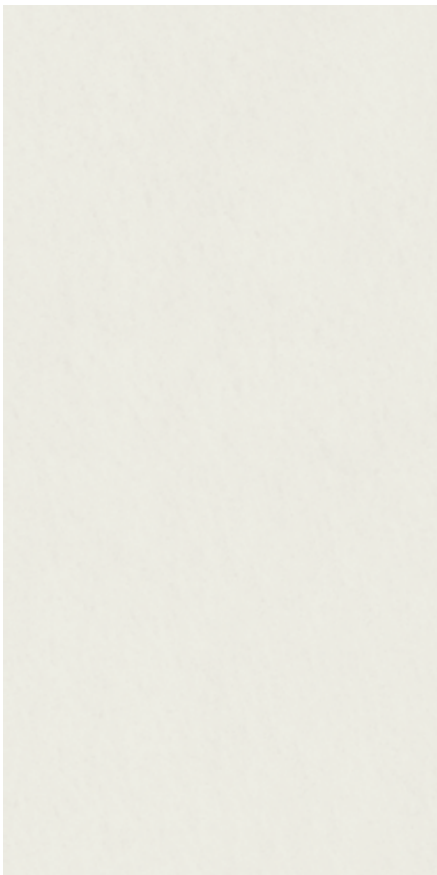

onix ice



* Su richiesta possono essere forniti stuoiati.
On demand these products are available also with fiber glass backing.

ferrocemento grigio



ceppo grigio



≠12

* 160x320 (63"x126")

matt non rett. 133 ●
 T616205 ferrocemento grigio
 T616375 ceppo grigio
 T616365 timber
 T616245 grafite

lucido non rett. 136 ●
 T616085 grafite

160x320 ≠12mm

timber



grafite



* Su richiesta possono essere forniti stuoiati.
 On demand these products are available also with fiber glass backing.

160x320 12mm



top: cave+ pietrasanta matt 12mm 160x320 (63"x126")

160x320 #12mm

IMBALLI packing - emballages - verpackung - УПАКОВКА

TILE+ F.TO NOMINALE / NOMINAL SIZE	mm.	TIPOLOGIA IMBALLO / PACKAGING		LASTRA / SLAB			CASSA - CAVALLETTI / CRATE - A-FRAME			
		ARTICOLO / ITEM	DIMENSIONE / SIZE	PCS	M2	KG	PCS	M2	KG VUOTO/EMPTY	KG TOT
160x320 N/rett.	12	1 cavalletto / A-frame 	75x330x194h	1	5,12	150	20	102,40	193	3193
	12	2 cassa / crate 	175x345x37h	1	5,12	150	9	46,08	163	1513

¹ I cavalletti vengono sempre addebitati al costo di € 250,00

A-frames are always charged at a cost of €250.00

Die Transportböcke werden zum Preis von € 250,00 berechnet.

Les chevalets sont toujours livrés à un coût de 250,00 €

За подставки всегда взимается плата в размере 250,00 €

² Nel caso di piccole forniture il materiale verrà consegnato in casse addebitate al costo di € 160,00

In the case of small orders the material will be shipped in crates charged at a cost of €160.00

Bei kleinen Lieferungen wird das Material in Kisten ausgeliefert, die zum Preis von € 160,00 berechnet werden.

En cas de petites fournitures, le matériel sera livré dans des caisses ayant un coût de 160,00 €

В случае маленьких поставок материал будет доставляться в ящиках стоимостью 160,00 €

08

technical section

sezione tecnica / section technique
Technischer abshnitt / Ктехнический раздел

grandi lastre - guida alla posa large format slabs: Storage – Handling – Installation	270	posa in opera laying pose verlegung colocación укладка	293
i vantaggi delle lastre “Modulo 90x270” advantages of ultra-thin ceramic tiles	271	stuccatura delle fughe joint sealing jointoiement verfugung der fugen estucado de las fugas заделка швов	294
movimentazione e carichi containers Handling Manipulation Handhabung	284	manutenzione e pulizia di pavimenti e rivestimenti maintenance and cleaning of floors and walls entretien et nettoyage des sols et revêtements instandhaltung und reinigung von fussböden und verkleidungen чистка и уход за напольной и облицовочной плиткой	294
gres porcellanato con colorazione in massa porcelained stoneware with mass colouring gres cerame avec pate coloree durchgefärbtes feinsteinzeug gres porcelánico con coloración en masa фарфоровый керамогранит, окрашенный по всей толщине	286	condizioni generali di vendita general sales conditions conditions générales de vente allgemeine verkaufsbedingungen condiciones generales de venta общие условия продажи	298
gres porcellanato smaltato glazed gres porcelain gres cerame emaille glasierte feinsteinzeug gres porcelánico esmaltado глазурованный фарфоровый керамогранит	288	2cm informazioni tecniche 2cm technical information 2cm informations techniques 2cm technische informationen 2cm información técnica 2cm техническая информация	302
nuove norme iso new iso standards nouvelles normes iso neue iso normen nuevas normas iso новые нормы iso	290	think green	306
caratteristiche tecniche di resistenza allo scivolamento anti-slip technical features caractéristiques techniques de résistance au glissement technische eigenschaften der rutschfestigkeit características técnicas de resistencia al deslizamiento технические характеристики сопротивления скольжению	291	leed	308
massetto di sottofondo e giunti foundation base and joints base en ciment et joints estrich und dehnungsfugen bloques de fondo y juntas подстилающая стяжка и швы	292		

GRANDI LASTRE

GUIDA ALLA POSA

Large format slabs: Storage - Handling - Installation

160x320

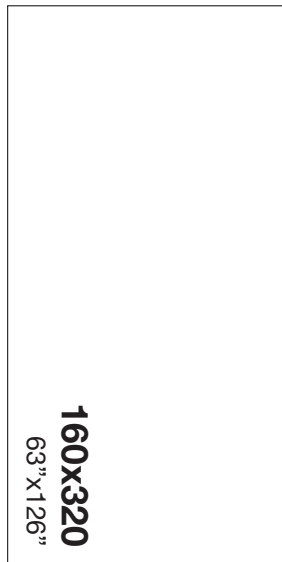

12 mm



technical section

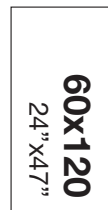
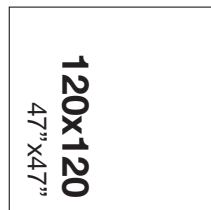
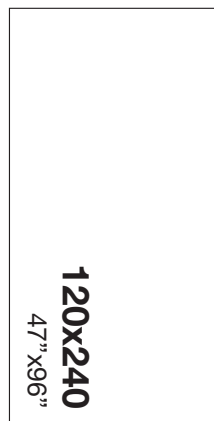
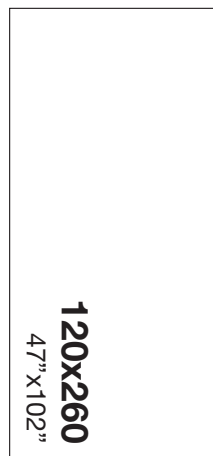

60x120
120x120
120x240
120x260

6,5 mm

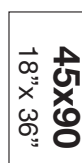
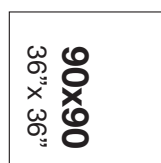

30x90
45x90
90x90
270x90
NEW SIZE

6 mm



NEW SIZE

I vantaggi delle lastre “modulo 90x270”

Advantages of ultra-thin ceramic tile

6 mm thick

(0,23")



- **facile da installare e da movimentare**
easy to install, easy to transport



- **posa a pavimento su massetto tradizionale e materiali preesistenti**
may be installed on existing floor

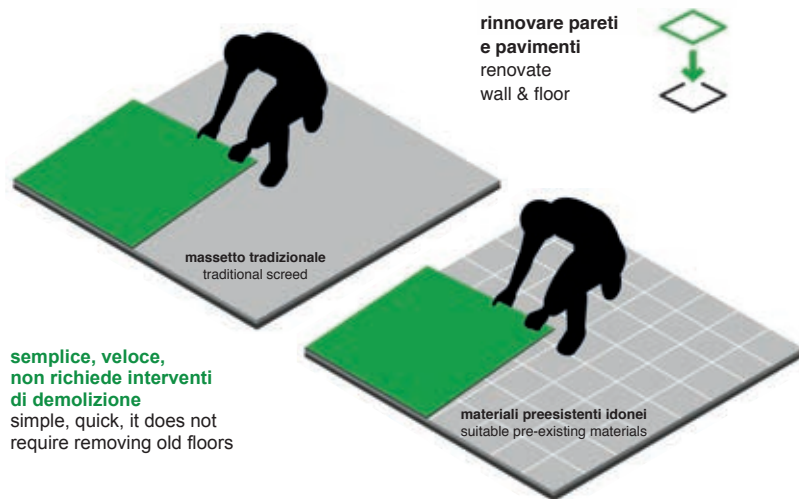

- **forte e resistente**
strong and durable

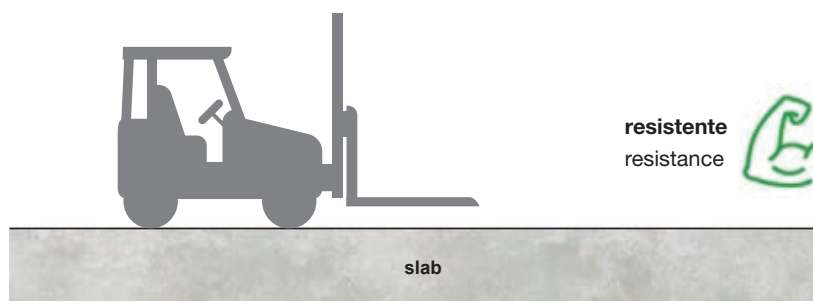

saime

technical section

I vantaggi delle lastre “modulo 90x270”

Advantages of ultra-thin ceramic tile

6 mm thick
(0,23")



4 formati modulari

4 modulated sizes

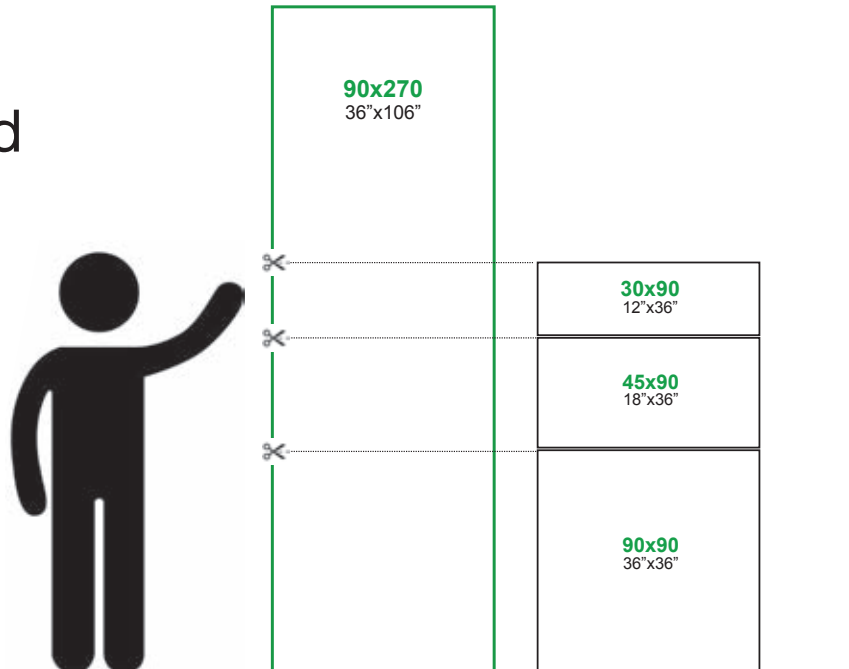

technical section

esempi di posa

laying suggestions

270 cm

90x270 (36"x106")
90x90 (36"x36")
45x90 (18"x36")
30x90 (12"x36")
6 mm thickness (0,23")

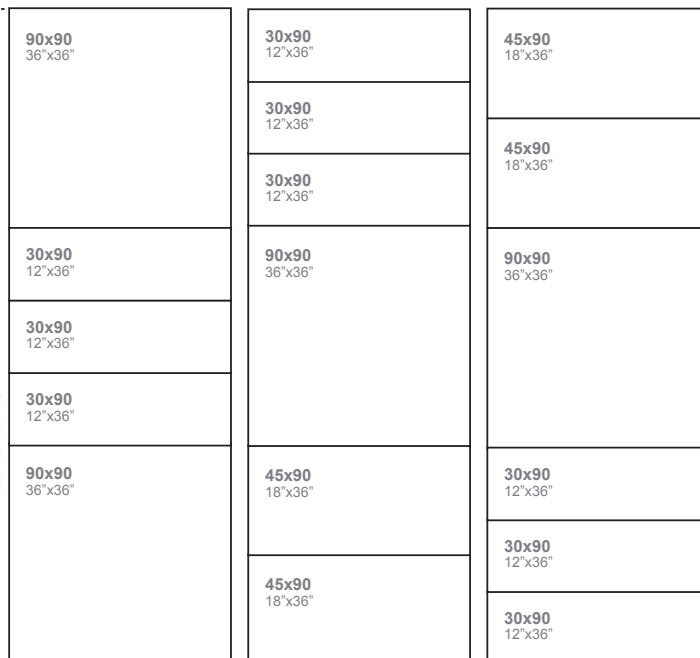

INTRODUZIONE / INTRODUCTION

Per *grande formato* si definiscono quelle lastre, quadrate o rettangolari, dove entrambi o solamente uno dei due lati risulta essere maggiore di 60 cm. / Large format refers to square or rectangular slabs where one or both of the dimensions is greater than 60 cm. (UNI 11493-1:2016).

1. **Lo stoccaggio a magazzino e l'imballo / Storage**
2. **La scelta dell'adesivo / Adhesive Selection**
3. **La movimentazione / Handling**
4. **La tecnica di posa / Installation Technique**
5. **Il taglio e la foratura / Cutting and Drilling**

1. MOVIMENTAZIONE E STOCCAGGIO DELLE LASTRE IMBALLATE STORAGE AND HANDLING THE PACKS

Le lastre in formato 90x90, 45x90, 30x90 cm sp.6 mm come le lastre 60x120, 120x120 cm sp.6,5 mm sono fornite disposte su pallet e protette da opportune sponde laterali / gabbie di protezione, che limitano urti accidentali. In fase di stoccaggio in magazzino, possono essere opportunamente sovrapposte per un massimo di 3 o 4 palette, a seconda del formato.

Le lastre in formato 90x270 cm sp. 6 mm e quelle 120x240 e 120x260 cm sp. 6,5 mm sono fornite in imballi costituiti da casse di legno, che possono essere opportunamente sovrapposte in fase di stoccaggio per un massimo di 5 casse.

La movimentazione delle lastre imballate deve sempre avvenire per mezzo di carrelli elevatori di idonea portata.

Sia i pallet che le casse di legno, devono sempre essere movimentati singolarmente e la lunghezza delle forche deve essere commisurata alle dimensioni dell'imballo (ad esempio, forche lunghe 1,5 m, se il materiale viene movimentato dal lato lungo, oppure 2,5 m, se le movimentate dal lato corto).

Le stesse forche devono poi essere predisposte in posizione di massima apertura, al fine di migliorare la stabilità dell'imballo durante la movimentazione.

90x90, 45x90, 30x90, 60x120, 120x120 cm formats → shipped on pallets with side collars/protective cages. Store in stacks up to a maximum of 3 or 4 pallets, depending on format.

Slabs in 90x270, 120x240, 120x260 cm format are packed in wooden crates. Store in stacks up to a maximum of 5 crates.

Handle using suitable capacity forklift trucks.

Move single packs: using fork depth suited to the size of the pack (e.g. 2.5 m for crates).

Use maximum fork width when moving → better pack stability.

2. SCELTA DELL'ADESIVO ADHESIVE SELECTION

La corretta scelta e prescrizione del collante è di fondamentale importanza nella posa di grandi formati. Più specificatamente, la migliore tipologia di adesivo deve essere scelta in funzione di:

- **Destinazione d'uso**
- **Condizioni di esercizio**
- **Tipologia di supporto**
- **Dimensione della lastra ceramica**

Di seguito alcuni accorgimenti generali che possono aiutare per selezionare il corretto adesivo:

- in generale, per la posa dei grandi formati su supporti "tradizionali" (ad esempio massetti cementizi) è consigliabile l'utilizzo di un adesivo di classe C2 caratterizzato da alta deformabilità (classe S2).
- per la posa in ambienti con climi freddi o umidi, o durante il periodo invernale quando la temperatura può abbassarsi sotto i 0°C, è consigliabile l'utilizzo di un adesivo a presa rapida (classe F) per facilitare la stagionatura dello strato di allettamento;
- per la posa in ambienti con climi caldi e secchi o con frequente ed abbondante ventilazione, o durante il periodo estivo quando la temperatura può raggiungere valori elevati, è consigliabile l'utilizzo di un adesivo a tempo aperto prolungato (classe E) per evitare che il collante crei la pellicola superficiale, inibendo del tutto il potere adesivo dello stesso. Importante: qualora si crei questa pellicola, è opportuno sottolineare che il collante perde ogni potere d'adesione e non può in nessun caso essere utilizzato;

- in virtù del tempo necessario per poter stendere il collante, specialmente per i formati più grandi quali il 90x90, 90x270, 120x120, 120x240 e 120x260cm, è normalmente consigliabile prescrivere un adesivo a tempo prolungato sia sul retro della lastra che sul supporto di posa.
- per la posa su supporti scarsamente porosi (ad esempio, pavimentazioni in grès preesistenti) o con umidità elevata (ma sempre al di sotto dei requisiti dettati dalla normativa UNI 11493-1:2016) è consigliabile l'utilizzo di un adesivo a presa rapida (classe F) per facilitare la stagionatura dello strato di allettamento.
- nel caso di posa su supporti in gesso, massetti in anidrite o solfato di calcio, è sempre consigliabile prevedere la stesura di un opportuno *primer* precedentemente le operazioni di posa.
- nel caso di posa a parete in esterno, ove le lastre in ceramica sono sottoposte a sensibili movimenti di contrazione-dilatazione per effetto dei gradienti termici diurni e stagionali, si rende necessario l'utilizzo di un adesivo altamente deformabile, capace di assecondare i naturali movimenti del rivestimento, ammortizzando così le tensioni generate sul sottostante supporto e producendo un rilassamento dello sforzo che evita il distacco del rivestimento ceramico dal supporto.

A titolo indicativo, si riporta di seguito una tabella ove sono indicati i requisiti minimi consigliati per la posa di lastre di grande formato, a seconda dell'ambiente e del tipo di supporto.

Choose adhesive on the basis of:

- **End use**
- **Installation conditions**
- **Support type**
- **Dimensions of ceramic slab**

Indications for adhesive selection

- Traditional supports (cementitious screed) → highly flexible Class C2 adhesives (Class S2)
- Installation in cold, humid climates, during winter → quick setting adhesive (Class F)
- Installation in hot, dry climates with good ventilation, or during summer → adhesive with extended open time (Class E). Installation must be fully complete before the adhesive forms a skin (causing it to lose all adhesive power).
- Installation on low-porosity supports (pre-existing ceramic tile) or under high humidity → fast-setting adhesives (Class F), for more rapid curing;
- Installation on plaster, anhydrite or calcium sulphate screeds → primer prior to installation
- Installation on external walls → Class S2 highly deformable adhesives, for absorption of cladding movement.

Tipologia di supporto Support type	Posa in interno Interior installation		Posa in esterno Exterior installation	
	pavimento floor	parete wall	pavimento floor	parete wall
Massetti cementizi senza sistema di climatizzazione radiante Cementitious screed without radiant heating/cooling	C2 E S1		C2 E S2	
Massetti cementizi con sistema di climatizzazione radiante Cementitious screed with radiant heating/cooling	C2 E S2			
Massetti in anidrite o solfato di calcio, con o senza sistema di climatizzazione radiante Anhydrite or calcium sulphate screed, with or without radiant heating/cooling	C2 E S2		C2 E S2	
Pavimentazioni preesistenti in ceramica o pietra Pre-existing flooring in ceramic tile or stone	C2 F E S2		C2 F E S2	
Parete in calcestruzzo Cement wall		C2 T E S2		C2 T E S2
Intonaco cementizio Cementitious plaster		C2 T E S2		C2 T E S2
Pannelli o superfici in metallo, pannelli e compositi di legno, gomma, resilienti Metal panels or surfaces, wood panels and composites, rubber, resilient materials	R2 T ¹	R2 T ¹	R2 T ¹	R2 T ¹

¹ indicazione di massima. Vista la varietà e le peculiarità di tali supporti, è sempre necessario consultare, prima della scelta, il produttore dell'adesivo.

3. MOVIMENTAZIONE DELLE LASTRE NELLE FASI PRECEDENTI LA POSA / HANDLING

Una volta estratto dall'imballo il cartone e, da esso, la lastra, movimentarla con cura prestando particolare attenzione agli angoli per evitare sbeccature o rotture, seguendo i consigli che di seguito sono meglio esplicitati.

Il numero di operatori addetti alla movimentazione varia in funzione del formato delle lastre stesse. In qualsiasi caso, tutti gli addetti alla movimentazione devono essere sempre muniti di idonei dispositivi di sicurezza e protezione individuali.

Per i formati 90x90 occorre un operatore, due operatori per i formati 120x120. Si segnala che esistono opportune mono o bi-ventose, che facilitano il sollevamento, la movimentazione (e dunque la posa nella fase successiva). Prima di applicare le ventose, è consigliabile utilizzare una spugna bagnata od uno straccio inumidito sia sulla superficie della lastra che sulla ventosa stessa, al fine di eliminare polvere o residui che ne diminuiscono sensibilmente il potere adesivo. L'utilizzo di mono o bi-ventose di tipo Vacuum (ossia a vuoto controllato) è normalmente da preferirsi perché, oltre a consentire una maggiore azione di presa sulla superficie (anche strutturata), consentono in continuo di verificarne l'entità per mezzo del manometro installato.

Infine, quattro operatori sono normalmente consigliati per la movimentazione di lastre in formato, 90x270, 120x240 e 120x260 cm. In questo ultimo caso, i quattro operatori possono spostare la lastra mediante opportuni telai / profili modulabili (in base al formato della lastra, vedi immagini sottostanti) dotati di ventose. L'utilizzo di ventose tipo Vacuum (a vuoto controllato) è da preferirsi in luogo alle normali bi-ventose in commercio.

Con una spugna bagnata od uno straccio inumidito, eliminare polvere o residui che possono essere presenti sulla lastra ed inumidire tanto la superficie quanto la gomma delle ventose stesse.

Una volta sollevata la lastra, essa deve essere posizionata in maniera stabile su di un supporto che ne consenta la movimentazione in posizione verticale e la successiva spalmatura del collante.

A tale scopo, si segnala che in commercio esistono diverse tipologie di telai verticali mobili, o carrelli, nei quali è possibile incastrare saldamente i profili di sollevamento sopra menzionati. Durante la fase del trasporto della lastra, evitare il più possibile brusche oscillazioni o vibrazioni del materiale. **(1,2)**

Remove boxes from the pack, handling them with care. Be careful of the edges to avoid chips and breakage.

Number of personnel recommended for handling:

- 90x90 → one worker
- 120x120 → two workers
- 90x270, 120x240, 120x260 → preferably four workers (at least two) using suction cup handling devices

Position the slab in a stable manner on supports, allowing movement into vertical position and subsequent application of adhesive (movable vertical racks). Use of suction cup devices with pressure gauge is recommended → for continuous monitoring of suction grip.

Avoid sudden oscillations and vibration of the material when transporting the slab. **(1,2)**



1



2

technical section

4. PRESCRIZIONI GENERALI RIGUARDANTI LA TECNICA DI POSA DEI GRANDI FORMATI INSTALLATION TECHNIQUE

Fatta salva l'idoneità del supporto su cui le lastre saranno installate, una corretta tecnica di posa rappresenta un caposaldo fondamentale da seguire fedelmente al fine di ottenere le migliori performances tecniche da una pavimentazione/rivestimento.

Sia a pavimento che a rivestimento, il requisito fondamentale per una posa a regola d'arte è il raggiungimento del letto pieno d'adesione, vale a dire la condizione in cui lo strato di adesivo tra il retro della lastra ed il supporto di posa è il più possibile continuo, compatto e privo di vuoti. **(3)**

A pavimento, questa condizione permette alla piastrellatura ceramica di resistere alle sollecitazioni meccaniche per le quali è stata progettata. A rivestimento, la condizione di letto pieno assicura una sicura adesione tra ceramica e muratura che eviti distacchi, ribaltamenti, ecc.

La fuga a giunto unito è in generale da sconsigliarsi per ragioni tecniche, prediligendo in ogni caso la posa a giunto aperto **(4)**, particolarmente indicata nel caso di lastre di grande formato o esposte a livelli di sollecitazione meccanica e igrotermica elevati. Questo tipo di posa permette di ridurre sensibilmente il modulo di elasticità della piastrellatura, e quindi la sua rigidità, impedendo in misura relativamente efficace i rischi di sollevamento, distacco o fessurazione delle lastre stesse.

L'interposizione di opportune giunture tecniche (giunti di deformazioni, perimetrali, frazionamento) nelle quali le fughe sono inscritte permette alla pavimentazione di sopportare meglio le sollecitazioni meccaniche e termo-igrometriche a cui la piastrellatura dovrà resistere.

I giunti perimetrali sono posti lungo il confine dell'ambiente da rivestire, ed in corrispondenza di tutti gli elementi della costruzione (pilastri, colonne, tubi).

I giunti di frazionamento a pavimento devono suddividere le piastrellature di grandi dimensioni in campiture di forma approssimativamente quadrata. Interessano tutto lo spessore della piastrellatura (lastra ed adesivo) e parte del supporto, per circa 1/3 del suo spessore.

È consigliabile mantenere un'area massima delle campiture dei giunti di frazionamento pari a 24 / 25 m² in ambienti interni e 9 / 10 m² in ambienti esterni. Il rapporto tra il maggiore ed il minore dei lati della campitura non deve essere maggiore di 1,5. I giunti di dilatazione interessano esclusivamente lo spessore della piastrellatura (ceramica + adesivo) e devono integrare ed includere la campitura dei giunti di frazionamento per suddividere ulteriormente, laddove ve ne sia bisogno in forza di sollecitazioni meccaniche o termo-igrometriche severe, la piastrellatura in riquadri dilatanti più fitti.

Per dimensionamento della larghezza dei giunti (i cui valori oscillano normalmente tra 5 e 12 mm) si tiene conto delle sollecitazioni meccaniche e termo-igrometriche d'esercizio della piastrellatura e delle capacità elastiche del materiale che costituisce il giunto (in ogni caso, nella realizzazione di tali giunti, è opportuno seguire le indicazioni di fabbricazione fornite dal produttore). **(5, 6, 7)**



3



4



5

Full-bed adhesion: the adhesive layer between slab rear and support is as continuous, compact and free of voids as possible. **(3)** This is achieved by double spreading.

Open-joint installation: always recommended, and especially in locations with high levels of mechanical or hygrothermic stresses **(4)**. Reduces the elastic modulus of the tiling, lessening risks of raising, detachment and cracking in the finished tiling.

Technical joints: the tile edges are inserted in the joints → gaining better support against mechanical and hygrothermic stresses.

Perimeter joints, around the edges of the area to be tiled and against intervening structural elements

Subdivision joints, inserted through the thickness of the slab + adhesive + 1/3 of screed

Expansion joints, inserted only through slab + adhesive

Sizing subdivision joints – area:

- 24 - 25 m² for interior installations
- 9 - 10 m² for exterior installations
- length/width ratio: < 1.5.

Sizing subdivision joints – joint width: on the basis of mechanical and hygrothermic stresses of the tiling installation and elastic capacities of the joint materials. **(5, 6, 7)**



6



7

technical section

4.1 POSA DELLE LASTRE A PAVIMENTO / FLOOR INSTALLATION STEPS

Per effettuare una posa a pavimento a regola d'arte, consigliamo questi passaggi:

- Stendere il collante sul supporto di posa, avendo cura di aver precedentemente verificato che possieda tutti i requisiti di qualità necessari per la posa di lastre in grande formato. L'adesivo deve essere steso con una spatola dentata (possibilmente a rebbi inclinati) da 10 mm lungo una sola direzione, preferibilmente quella parallela al lato corto in caso di piastrella rettangolare. Questo accorgimento facilita l'espulsione dell'aria durante la fase di vibrazione e contribuisce ad ottenere il letto pieno d'adesione.
- Stendere il collante sul retro della lastra, con una spatola dentata da 3 mm, nella medesima direzione utilizzata per spalmare il collante sul supporto di posa.
- Movimentare la lastra provvista di strato di adesivo e posizionarla sul supporto di posa ove è stato precedentemente steso il collante.
- Nel caso di posa dei formati 90x270, 120x120, 120x240 e 120x260 cm è consigliabile l'utilizzo dei predetti carrelli che consentono un trasporto in tutta sicurezza ed aiutano gli operatori a posizionare la lastra in orizzontale. **(8)** In caso di



8

altri formati, la movimentazione ed il posizionamento delle lastre può avvenire tramite mono o bi-ventose e senza l'ausilio di telai preposti. **(9)**

Una volta posizionata, muovere delicatamente la lastra, facendo compiere piccoli spostamenti in tutte e quattro le direzioni del piano.

- Nell'effettuare il posizionamento delle lastre adiacenti, rispettare le distanze per le fughe imposte dai distanziatori. A tal proposito, nel caso di lastre di grande formato si consigliano opportuni livellatori che facilitano il processo di allineamento delle fughe ed al contempo aiutano nell'evitare dislivelli tra una lastra e l'altra.

Infine, segnaliamo che vi sono opportuni attrezzi, detti "accosta-lastre" che permettono di effettuare movimenti di precisione per ottenere un corretto posizionamento. **(10)**

Effettuare una opportuna vibrazione utilizzando frattazzi antirimbalzo manuali o vibratori elettrici, partendo dal centro della lastra verso i lati della stessa, su tutta la superficie in maniera continua ed uniforme. **(11)** Questa operazione è necessaria in quanto consente di eliminare i vuoti all'interno dello strato di collante ed aiuta il raggiungimento della condizione di letto pieno d'adesione. Per questa operazione, si consiglia di non utilizzare martelli ancorché gommati.

- Attendere la stagionatura del collante, secondo le indicazioni fornite dal produttore, prima di camminare sopra la superficie della pavimentazione. Per tutto il tempo della stagionatura, la pavimentazione deve risultare protetta da carichi accidentali. Le fughe non stuccate, devono essere protette da polvere e residui.



9



10

Spread the adhesive on the installation surface using a 10mm-toothed trowel, working in one direction only (parallel to short side for rectangular slabs).

Spread the adhesive on the rear of the slab using a 3mm-toothed trowel, working in matching direction.

Carefully move the slab into position, placing adhesive against the support surface.

Move the slab delicately, making small movements in all four surface directions.

Use slab-handling tools for precise movement into correct position.

(8, 9,10)

Vibrate using a manual anti-bouncing tile beater or electric tile vibrator, from slab centre to sides, continuously and uniformly over the entire surface. **(11)**

Wait for adhesive to set according to the manufacturer's instructions before walking on tiled surfaces. Avoid accidental loading of the surface. Protect joints prior to grouting: prevent accumulation of dust and dirt in open joints.



11

4.2 POSA DELLE LASTRE A RIVESTIMENTO / TIPS FOR WALL INSTALLATION

Per effettuare una posa a rivestimento a regola d'arte, seguire i passaggi già menzionati al capitolo precedente

- Stendere il collante sul supporto di posa, avendo cura di aver precedentemente verificato che possieda tutti requisiti di qualità necessari per la posa di lastre in grande formato. L'adesivo deve essere steso con una spatola dentata (possibilmente a rebbi inclinati) da 10 mm lungo una sola direzione, preferibilmente quella parallela al lato corto della lastra (onde facilitare l'espulsione dell'aria durante la fase di vibrazione ed assicurare il letto pieno d'adesione). Se il rivestimento prevede sistemi di aggancio di sicurezza "a vista", tipo Cp-Kerclip, prima della stesura del collante occorre ancorare i ganci al supporto con opportuni fissaggi di tipo meccanico (tasselli, sparachiodi, etc.) la cui estremità di testa possa essere "annegata" nello strato di adesivo steso **(12)**
- Stendere il collante sul retro della lastra, con una spatola dentata da 3 mm, nella medesima direzione utilizzata per spalmare il collante sul supporto di posa. Se il rivestimento prevede sistemi di aggancio di sicurezza "a scomparsa", tipo Cp-Kerfix, prima della stesura del collante è necessario eseguire l'incisione sul retro della lastra ove sarà alloggiato l'ancoraggio di sicurezza (nel caso in cui tale incisione non sia stata precedentemente effettuata in fabbrica). **(13)**
Nel caso di incisione in cantiere, la distanza reciproca tra le incisioni dovrà essere non inferiore a 40 cm l'una dall'altra e dovrà essere effettuata con opportuni utensili che sono stati appositamente studiati. Dopo l'incisione, e comunque sempre prima della stesura dell'adesivo, occorre incastrare il gancio di sicurezza Cp-Kerfix all'interno della fresatura.
- Movimentare la lastra provvista di strato di adesivo e posizionarla sul supporto di posa ove è stato precedentemente steso il collante. Nel caso di posa dei formati 90x270, 120x120, 120x240 e 120x260 cm è consigliabile l'utilizzo dei predetti carrelli che consentono un trasporto in tutta sicurezza ed aiutano gli operatori a posizionare la lastra in orizzontale. In caso di altri formati, la movimentazione ed il posizionamento delle lastre può avvenire tramite mono o bi-ventose e senza l'ausilio di telai preposti.
- Una volta posizionata, muovere delicatamente la lastra, per mezzo del telaio a ventosa, facendo compiere piccoli spostamenti in tutte e quattro le direzioni.

Nell'effettuare il posizionamento delle lastre adiacenti, rispettare le distanze per le fughe. L'utilizzo dei sistemi livellatori è possibile e consigliabile anche nel caso di posa a rivestimento verticale.

- Effettuare una opportuna vibrazione utilizzando frattazzi antirimbazzo "manuali" o vibratorii elettrici, partendo dal centro della lastra verso i lati della stessa, su tutta la superficie in maniera continua ed uniforme. Questa operazione è necessaria in quanto consente di eliminare ogni tipo di vuoto all'interno del letto pieno d'adesione.
- Correggere eventuali difetti di planarità avvalendosi dei sistemi di livellamento in corrispondenza dei distanziali delle fughe.

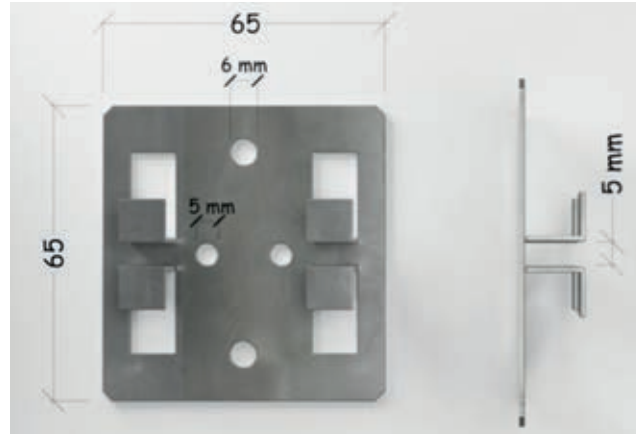

12



13

- Ancorare i ganci del sistema Cp-Kerfix al supporto di posa con opportuni fissaggi meccanici (tasselli, sparachiodi, etc.) la cui estremità di testa possa essere "annegata" nello strato di adesivo steso.
- Attendere la stagionatura del collante, secondo le indicazioni fornite dal produttore, prima di effettuare qualsiasi operazione sul rivestimento (fori, incisioni, etc.) o applicare carichi alla piastrellatura.

If installing wall cladding using (Cp-Kerclip) visible safety systems, anchor the clips to the support prior to spreading the adhesive (using anchors, nailgun, etc.) **(12)**

- If installing wall cladding using (Cp-Kerfix) invisible safety systems, cut the back of the slab prior to spreading the adhesive. If the slab cuts are carried out at the worksite, the distance between cuts must be > 40 cm.
- Carefully move the slab into position, placing the adhesive layer against the support surface. Anchor the Cp-Kerfix clips to the support surface. **(13)**
Wait for adhesive to set according to the manufacturer's instructions before carrying out any cladding operations (holes, cuts, etc.), and before applying any loads to the tiling.

4.3 TAGLIO DELLE LASTRE / CUTTING AND DRILLING

Per il taglio di lastre di grande formato occorre premunirsi di una opportuna attrezzatura che permetta di effettuare tali operazioni in tutta sicurezza, sia per l'incolumità dell'operatore sia per preservare l'integrità della lastra stessa.

L'utilizzo di taglierine professionali ad acqua è da preferirsi per ottenere una migliore qualità del taglio (14,15)



14

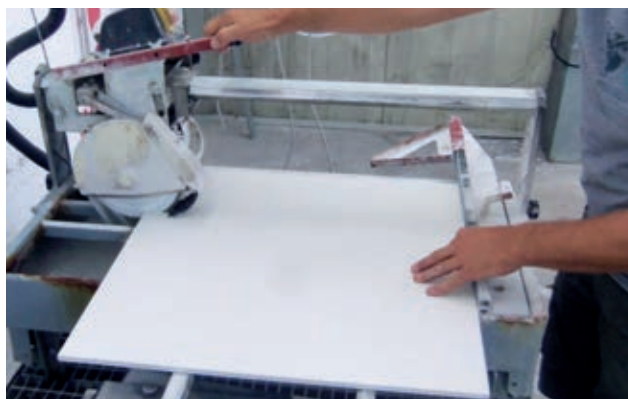

15

Water cutting, using professional equipment for higher quality cuts. (14,15)

Nel caso di taglio a secco, a seconda della tipologia di taglio e del formato della lastra, possono essere impiegati diverse varietà di utensili:



16



17



18

- Segnaliamo che in commercio esistono taglierine di dimensioni idonee per tagliare lastre di formato fino al 60x120 cm (16)

- Lastre di dimensioni maggiori (ad esempio 90x90, 90x270, 120x120, 120x240 e 120x260cm) devono essere posizionate su di un piano rigido e stabile, che possa assorbire eventuali vibrazioni indotte dagli utensili di taglio, il quale può essere effettuato mediante idonee guide già equipaggiate di rotelle diamantate. Le guide devono essere ben ancorate alla lastra. (17, 18, 19)

- Qualsiasi sia l'utensile prescelto per effettuare un'operazione di questo genere, al fine di ottenere una linea di taglio ben definita e senza sbavature, si consiglia di controllare preventivamente lo stato di usura della rotellina di incisione e sostituirla, nel caso di usura evidente, con una nuova al widia/titanio o lega di carbonio. L'incisione deve essere progressiva ed uniforme, senza esercitare una eccessiva pressione in alcuni punti, mantenendo una velocità ed una forza costante lungo tutta la linea di incisione.

La fase troncatura, nel caso di tagli su lastre adagiate su di un piano di lavoro, deve essere effettuata mediante opportune pinze che agiscono, in contemporanea, sulle estremità delle linee di taglio ed una in mezzzeria, in modo da effettuare una pressione di troncatura quanto più continua lungo tutta l'incisione. (20, 21, 22)

- Per effettuare tagli a scasso o riseghe, si può usare una comune smerigliatrice angolare munita di disco diamantato idoneo allo spessore della lastra. Per i formati più grandi, segnaliamo che alcune guide di taglio sono già predisposte per alloggiare la smerigliatrice angolare

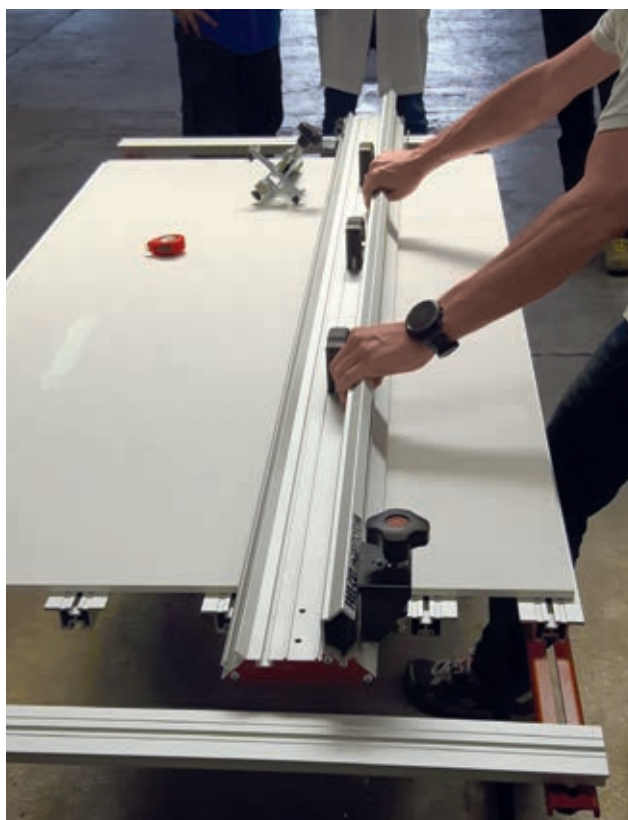

19

su di esse, in modo da guidare l'operatore durante la fase di incisione/taglio in maniera precisa e lineare. **(23, 24)**

- In tutti i casi, si consiglia di dosare la velocità di avanzamento del disco diamantato proporzionalmente alla durezza del materiale: imprimere una velocità eccessiva potrebbe causare il danneggiamento della macchina, la deformazione del disco diamantato e la rottura della piastrella.

Dry cutting - select tools depending on the type of cut and slab format:

- Linear cutters for formats up to 60x120 cm. **(16)**
- 90x90, 90x270, 120x120, 120x240 and 120x260 cm formats → cut using a diamond blade with guide on a stable, rigid worktable, capable of absorbing vibrations from cutting tools. **(17, 18, 19)**
- Position the slabs on a solid, stable and rigid surface, capable of absorbing vibrations from cutting tools.
- Anchor the cutting guide to the slab. Most guides come with diamond cutters.

Cut with uniform pressure, maintaining constant movement and force along the entire line of the cut. **(20, 21, 22)**

- Break using purpose-made pliers, acting simultaneously at the two extremities and at the centre of the cut line.
- Angle grinder with diamond disc for straight-line cuts on medium-large formats **(23, 24)**
- Angle grinder mounted on cutting guide
- Recommendation: advance the diamond disc at speeds suited to the hardness of the material. Going too fast can damage the grinder, deform the diamond disc, and/or break the slab.

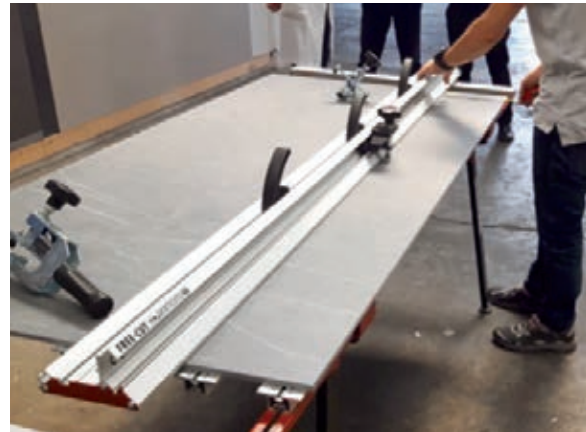

20



21



22

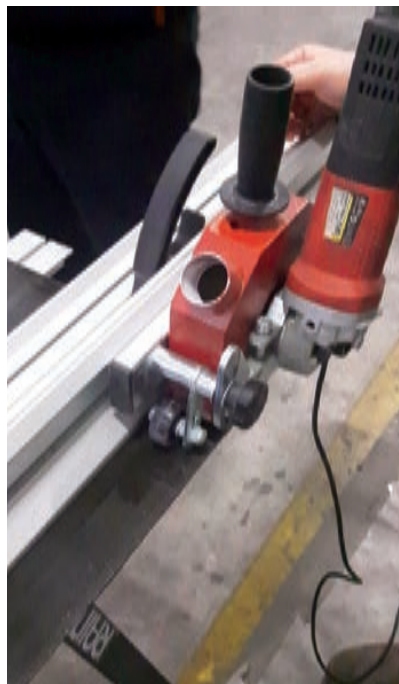

23



24

5. FORATURA DELLE LASTRE /

LINEAR CUTS / POCKET CUT ON WORKTABLE / CIRCULAR HOLES / POCKET CUTS

Di seguito segnaliamo alcuni accorgimenti che permettono di realizzare sulle lastre in grès porcellanato fori e aperture (quadrate o rettangolari) in modo agevole e superando le situazioni più difficili, operando in sicurezza e con professionalità. In tutti i casi, l'operazione deve essere condotta su una superficie piana, stabile, adagiando la piastrella possibilmente su un foglio di polistirolo o di gomma morbida, per attenuare le vibrazioni e rendere più sicuro il lavoro **(25)**. A tal fine, si segnala che in commercio esistono idonei banchi che fungono da supporto durante le operazioni di taglio e foratura, che permettono di effettuare tali operazioni garantendo sicurezza per l'operatore e integrità per la lastra.

La soluzione più rapida per praticare fori circolari su piastrelle in grès porcellanato è quella di ricorrere a frese diamantate professionali applicabili ai comuni flessibili per dischi intercambiabili (disponibili in vari diametri da 6 mm a 75 mm), in grado di realizzare un foro in pochi minuti e lasciando la superficie della piastrella integra e priva di scheggiature sul contorno dell'apertura.

E' importante realizzare il foro facendo oscillare la fresa con movimento rotatorio, senza esercitare eccessiva pressione sul punto d'attacco, avendo l'accortezza di nebulizzare costantemente con acqua il punto esatto ove si vuole realizzare il foro. **(26)**

La nebulizzazione produce il duplice beneficio di allungare la vita utile della fresa e ridurre l'attrito fresa/ceramica, principale responsabile di eventuali sbeccature e micro-cricche che potrebbero formarsi. Prima di incidere con fresa diamantata, è inoltre consigliabile verificarne lo stato di usura del diamante: frese eccessivamente usurate possono portare a risultati non ottimali. È consigliabile realizzare il foro in più riprese, nebulizzando/bagnando costantemente l'area di incisione

Nel caso di aperture rettangolari o quadrate, la tecnica dell'incisione e taglio con solo disco montato su flessibile (spesso non idoneo al grès porcellanato) risulta oltremodo difficoltosa e dall'esito incerto: lo stress provocato dal taglio e le vibrazioni trasmesse al materiale, in condizioni di lavoro assai precarie come si riscontrano spesso nei cantieri, può provocare fessurazioni e rotture anche dopo l'incollaggio del pezzo.

Nella maggior parte dei casi, il tutto è risolvibile procedendo nel seguente modo:

- seguendo la procedura sopra descritta per la realizzazione dei fori ed utilizzando frese diamantate professionali, realizzare 4 fori del diametro di circa 5-7 mm in corrispondenza dei vertici che delimitano l'apertura, con l'utilizzo di un trapano non a percussione
- incidere delicatamente e progressivamente la piastrella da foro a foro con flessibile e disco diamantato professionale idoneo per grès porcellanato.

Di importanza fondamentale in questa delicata fase di taglio è la qualità e la struttura del disco diamantato che, operando a velocità molto elevata, deve mantenere integre le proprie caratteristiche di rigidezza e taglio **(27, 28, 29, 30)**



25



26



27

Support the slab on a flat, stable surface (worktable, polystyrene or soft rubber sheet) **(25)**

Use professional-quality diamond bits (for use with angle-grinders), 6 to 75 mm diameter.

Rock the cutter bit in a rotating motion, avoiding excessive pressure; apply a constant spray of water. **(26)**

Complete the cutting in steps, spraying/bathing the area of the hole constantly.

Cut 4 holes of about 5-7 mm diameter, corresponding to the borders of the pocket corners. If necessary, cut more holes along the borders of the pocket opening. Cut the slab delicately and continuously from one hole to the next, using angle grinder and professional-quality diamond disc for porcelain tiles **(27, 28, 29, 30)**



28

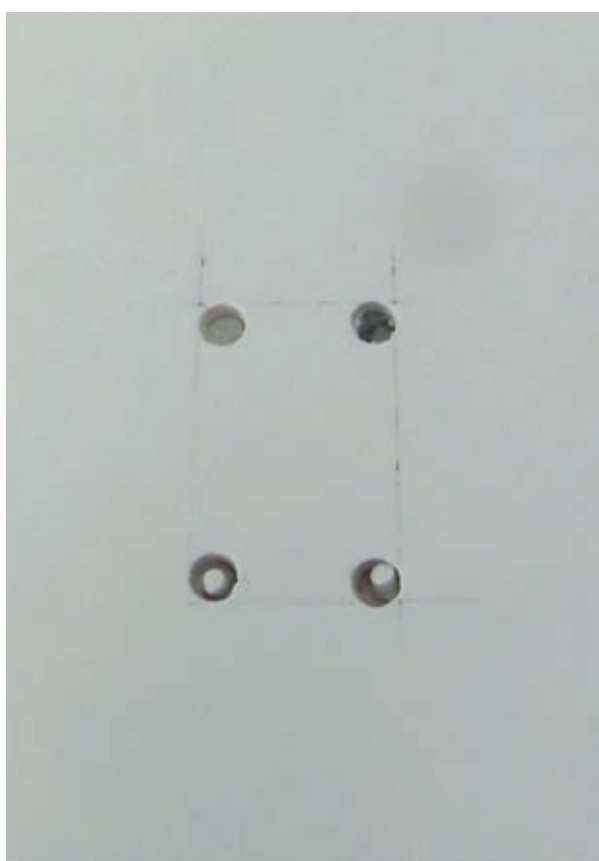

29



30

Movimentazione

Handling/Manipulation/Handhabung

technical section

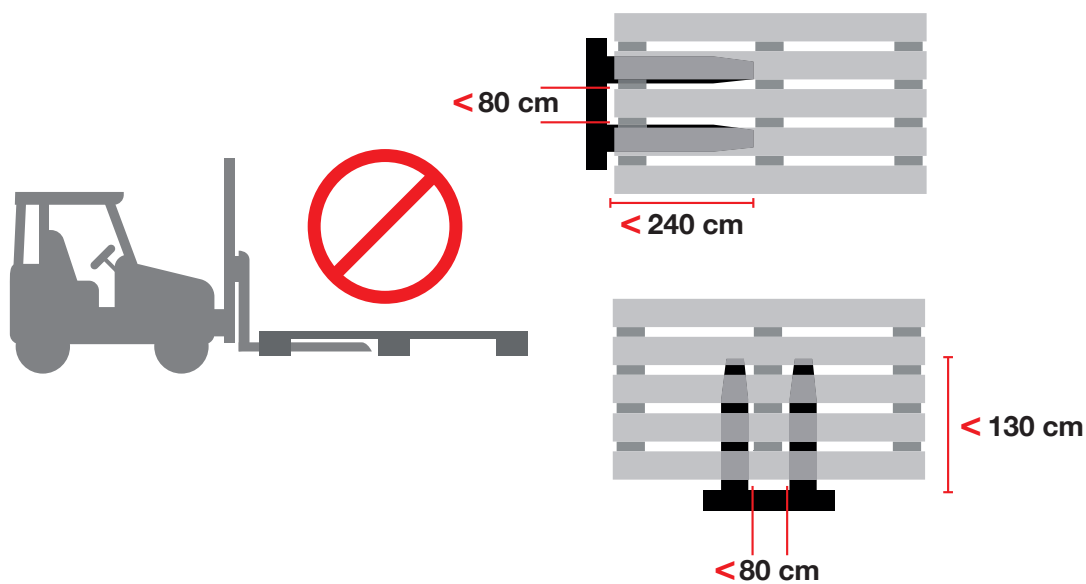
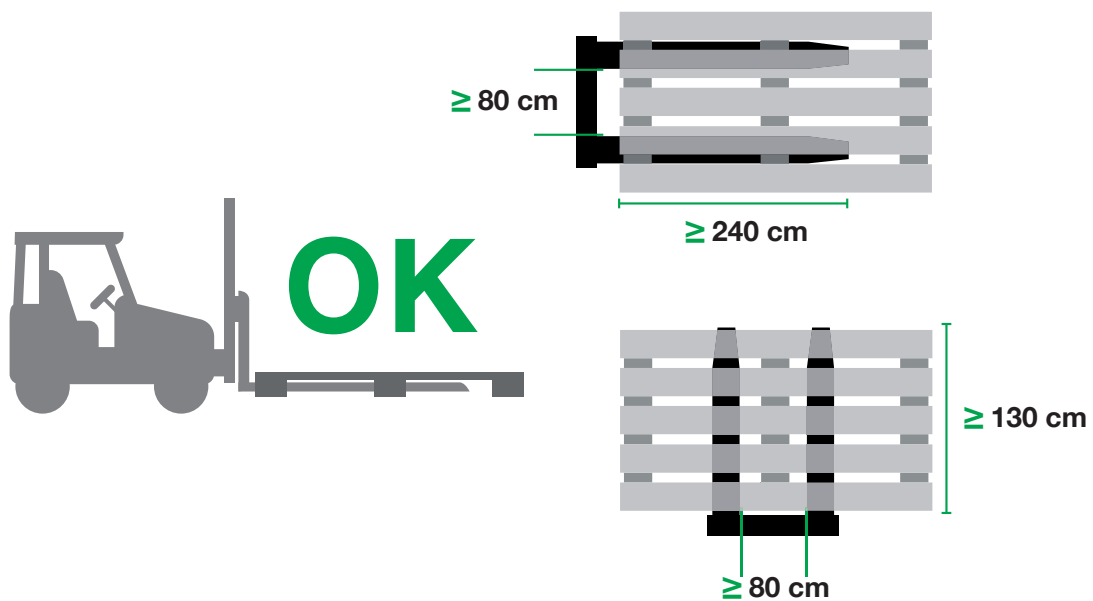



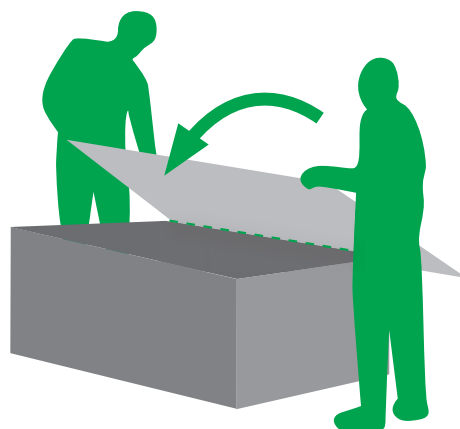
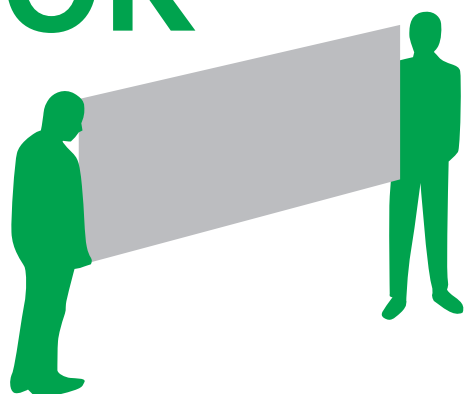



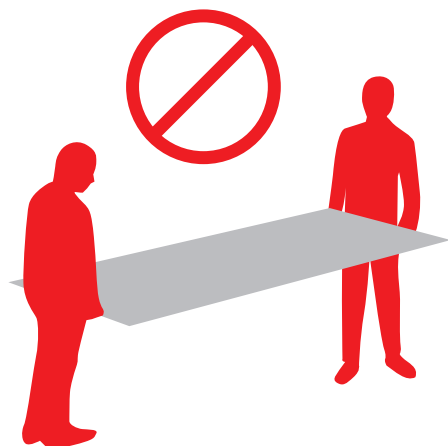







OK



technical section



	GRES PORCELLANATO CON COLORAZIONE IN MASSA		GRUPPO DI APPARTENENZA SECONDO ISO 13006		
	PORCELAINED STONEWARE WITH MASS COLOURING GRES CERAME AVEC PATE COLOREE DURCHGEFÄRBTES FEINSTEINZEUG GRES PORCELÁNICO CON COLORACIÓN EN MASA ФАРФОРОВЫЙ КЕРАМОГРАНИТ, ОКРАШЕННЫЙ ПО ВСЕЙ ТОЛЩИНЕ		CLASS GROUPE D'APPARTENANCE ZUGEHÖRIGKEITSGRUPPE GRUPO DE PERTENENCIA ГРУППА ПРИНАДЛЕЖНОСТИ		
Simbologia Symbolics Symboles Symbole Simbologias Символы	Caratteristiche Features Caracteristiques Eigenschaften Caracteristicas Характеристика	Unità di misura Unit of measurement Unité de mesure Masseinheit Unidad de medida Единица измерения	Valore medio Saime Saime mean value Valeur moyenne Saime Durchschnittswert-Saime Valor medio Saime Среднее значение Saime	Valore prescritto Fixed value Valeur prescrite Vorgeschriebener Wert Valor prescrito Требуемое значение	Metodo di prova Test method Méthode d'essai Prüfmethode Método de ensayo Метод испытания
	Rettilinearità dei lati Side straightness Rectitude des arêtes Geradlinigkeit der Kanten Rectilíneidad de los lados Прямолинейность сторон	%	+/- 0,4	+/- 0,5 max	UNI EN ISO 10545-2
	Ortogonalità degli spigoli Corner squariness Angularité Rechtwinkligkeit der Kanten Ortogonalidad de las esquinas Ортогональность кромок	%	+/- 0,4	+/- 0,6 max	UNI EN ISO 10545-2
	Planarità Flatness Planéité Ebenfächigkeit Planeidad Плоскостность	%	+/- 0,4	+/- 0,5 max	UNI EN ISO 10545-2
	Spessore Thickness Epaisseur Dicke Grosor Толщина	%	+/- 5,0	+/- 5,0 max	UNI EN ISO 10545-2
	Assorbimento d'acqua Water absorption Absorption d'eau Wasseraufnahme Absorción de agua Водопоглощение	%	< 0,2	≤ 0,5	UNI EN ISO 10545-3
	Sforzo di rottura Breaking strenght Contrainte de rupture Bruchkraft Esfuerzo de rotura Разрушающее усилие	N	> 1600	≥ 1300 se Spess. ≥ 7,5 ≥ 700 se Spess. ≤ 7,5	UNI EN ISO 10545-4
	Modulo di rottura Modulus of rupture Coefficient de rupture Bruchmodul Módulo de rotura Модуль разрыва	N/mm ²	> 40	≥ 35	UNI EN ISO 10545-4
	Dilatazione termica lineare Coeff. of linear thermal expansion Coeff. d'extension thermique linéaire Linearer Wärmeausdehnungs-Koeffizient Coeficiente de dilatación térmica lineal Линейное тепловое расширение	°MK (-1)	7,0	metodo disponibile available method méthode disponible verfügbare methode método disponible требуемое значение	UNI EN ISO 10545-8
	Resistenza agli sbalzi termici Thermal shock resistyance Résistance aux chocs termiques Temperaturwechsel Beständigkeit Resistencia a choque térmico Стойкость к перепадам температуры	-	resiste resist résiste widerstandsfähig resiste стойкий	metodo disponibile available method méthode disponible verfügbare methode método disponible требуемое значение	UNI EN ISO 10545-9
	Resistenza alle macchie Stain resistance Résistance au tâches Flecken Beständigkeit Resistencia a las manchas Стойкость к образованию пятен	-	≥ 3	3 MIN	UNI EN ISO 10545-14
	Resistenza ai prodotti chimici di uso domestico Resistance to chemical products Résistance aux produits chimiques Beständigkeit gegen Chemikalien Resistencia a los productos químicos Стойкость к бытовым химикатам	-	conforme conform conforme gleichmässig conforme соответствует	MIN GB	UNI EN ISO 10545-13
	Resistenza agli acidi e alle basi a bassa concentrazione Resistant to acids and low concentration bases Résistance aux acides et aux bases à faible concentration Widerstandsfähig gegenüber niedrig konzentrierten Säuren und Laugen Resistencia a los ácidos y las bases de baja concentración Стойкость к низким концентрациям кислот и щелочей	-	MIN GLB	secondo classificazione prodotto according to product classification selon classification produit Gemäß Produktklassifizierung СОГЛАСНО КЛАССИФИКАЦИИ ПРОДУКЦИИ	UNI EN ISO 10545-13
	Resistenza al gelo Frost resistance Résistance au gel Frostbeständigkeit Resistencia al hielo Морозостойкость	-	resiste resist résiste widerstandsfähig resiste стойкий	richiesta request demande anfrage solicitud требуемое значение	UNI EN ISO 10545-12
	Stabilità dei colori Colour stability Stabilité des coloris Lichtechtheit der Färbung Estabilidad de los colores Цветостойкость	-	stabile stable stable stabil estable стойкий	metodo disponibile available method méthode disponible verfügbare methode método disponible требуемое значение	DIN 51094

gres porcellanato **GM**

con colorazione in massa

Il gres porcellanato è un prodotto tecnico realizzato con argille speciali e materie prime selezionate cotto ad alta temperatura. Molto compatto, altamente sinterizzato, raggiunge per questo, un bassissimo grado di assorbimento e offre ai vari test i più elevati valori tecnologici. L'impasto a tutta massa, può essere miscelato a variegati polveri e ossidi per ottenere superfici venate, rustiche o ad effetti speciali. In questo caso si parla di Gres Porcellanato con colorazione in massa. Per apprezzare le differenze tra superficie naturale e lappato fare riferimento ai campioni reali.

PORCELAINED STONEWARE WITH MASS COLOURING

The porcelained stoneware is a technical product manufactured using kaolin and selected raw materials, fired at a high temperature. It is a very compact, highly sinterized product which for this reason has a very low level of absorption and responds with high technological values to various tests. The massive mixture can be mixed with coloured micro-granules to obtain the Vitrified Massive Stoneware, or it can be blended with various powders and oxides to obtain veined and rustic surfaces or surfaces with special effects. In this case it is called porcelained stoneware with mass colouring. Please refer to the actual samples to appreciate the differences between the natural and the semi-polished surface finish.

GRES CERAME AVEC PATE COLOREE

Le grès cérame est un produit technique réalisé avec des kaolins et des matières premières sélectionnés, cuit à haute température. Très compact, hautement synthétisé, il atteint pour cette raison un très faible taux d'absorption et présente, lors des différents tests, les valeurs technologiques les plus élevées. La pâte à toute épaisseur, peut être mélangée à des micro-granulés colorés pour obtenir des surfaces veinées, rustiques ou à effets spéciaux. Dans ce cas, on parle de Grès Cérame avec pate coloree. Afin d'apprécier les différences entre surface naturelle et lappato veuillez vous référer aux échantillons réels.

















DURCHGEFÄRBTES FEINSTEINZEUG

Das Feinsteinzeug ist ein technisches Produkt, das aus Kaolinen und ausgewählten Rohstoffen produziert und das bei hoher Temperatur gebrannt wird. Es ist sehr kompakt und durchgesintert und erreicht daher einen sehr niedrigen Absorptionsgrad und bietet bei den verschiedenen Tests die höchsten technischen Werte. Das Vollstärkengemisch kann zur Erzielung von porphyrisiertem Vollstärkenfeinsteinzeug mit farbigem Mikrogranulat oder zur Erzielung von geäderten, rustikalen Oberflächen oder besonderen Effekten mit Pulvern und Oxyden gemischt werden. In diesem Fall spricht man von durchgefärbtem Feinsteinzeug. Um die Unterschiede zwischen Naturale und Lappato Oberfläche zu erkennen, nehmen Sie bitte Bezug auf die realen Muster.

ФАРФОРОВЫЙ КЕРАМОГРАНИТ ОКРАШЕННЫЙ ПО ВСЕЙ ТОЛЩИНЕ

Фарфоровый керамогранит - это технический материал, изготовленный из специальной глины и отобранного сырья, обожженный при высокой температуре. Он является очень компактным материалом с высокой степенью спекания, поэтому обладает очень низким уровнем поглощения и показывает самые высокие технологические результаты при проведении различных испытаний. Однородную по всей толщине смесь можно смешивать с различными порошками и оксидами в целях получения поверхности с прожилками, специальными эффектами и негладкие поверхности. В таком случае речь идет о фарфоровом керамограните, окрашенном по всей толщине. Для оценки различий между натуральной и притертой поверхностью необходимо сравнить образцы продукции.



GS	GRES PORCELLANATO SMALTATO		GRUPPO DI APPARTENENZA SECONDO ISO 13006		 Bla GL
	Simbologia Symbolics Symboles Symbole Simbologias Символы	Caratteristiche Features Caracteristiques Eigenschaften Caracteristicas Характеристика	Unità di misura Unit of measurement Unité de mesure Masseinheit Unidad de medida Единица измерения	Valore medio Saime Saime mean value Valeur moyenne Saime Durchschnittswert-Saime Valor medio Saime Среднее значение Saime	
	Rettilinearità dei lati Side straightness Rectitude des arêtes Geradlinigkeit der Kanten Rectilíneidad de los lados Прямолинейность сторон	%	+/- 0,4	+/- 0,5 max	UNI EN ISO 10545-2
	Ortogonalità degli spigoli Corner squareness Angularité Rechtwinkligkeit der Kanten Ortogonalidad de las esquinas Ортогональность кромок	%	+/- 0,4	+/- 0,6 max	UNI EN ISO 10545-2
	Planarità Flatness - Planéité Ebenföchigkeit - Planeidad Плоскостность	%	+/- 0,4	+/- 0,5 max	UNI EN ISO 10545-2
	Spessore Thickness - Epaissieur Dicke - Grosor Толщина	%	+/- 5,0	+/- 5,0 max	UNI EN ISO 10545-2
	Assorbimento d'acqua Water absorption - Absorption d'eau Wasseraufnahme - Absorción de agua Водопоглощение	%	< 0,4	≤ 0,5	UNI EN ISO 10545-3
	Sforzo di rottura Breaking strenght Contrainte de rupture Bruchkraft Esfuerzo de rotura Разрушающее усилие	N	> 1500	≥ 1300 se Spess. ≥ 7,5 ≥ 700 se Spess. ≤ 7,5	UNI EN ISO 10545-4
	Modulo di rottura Modulus of rupture Coefficient de rupture Bruchmodul Módulo de rotura Модуль разрыва	N/mm ²	> 38	≥ 35	UNI EN ISO 10545-4
	Resistenza all'abrasione Resistance to abrasion Résistance à l'abrasion Beständigkeit gegen Oberflächenverschleiss Resistencia a la abrasión Спротивление истиранию	-	secondo la serie	Classe 1-5	UNI EN ISO 10545-7
	Dilatazione termica lineare Coeff. of linear thermal expansion Coeff. d'extension thermique linéaire Linearer Wärmeausdehnungs-Koeffizient Coeficiente de dilatación térmica lineal Линейное тепловое расширение	°МК (-1)	7,0	metodo disponibile available method méthode disponible verfügbare methode método disponible требуемое значение	UNI EN ISO 10545-8
	Resistenza agli sbalzi termici Thermal shock resistyance Résistance aux chocs thermiques Temperaturwechsel Beständigkeit Resistencia a choque térmico Стойкость к перепадам температуры	-	resiste resist résiste widerstandsfähig resiste стойкий	metodo disponibile available method méthode disponible verfügbare methode método disponible требуемое значение	UNI EN ISO 10545-9
	Resistenza alle macchie Stain resistance - Résistance au tâches Flecken Beständigkeit - Resistencia a las manchas Стойкость к образованию пятен	-	≥ 3	3 MIN	UNI EN ISO 10545-14
	Resistenza ai prodotti chimici di uso domestico Resistance to chemical products Résistance aux produits chimiques Beständigkeit gegen Chemikalien Resistencia a los productos químicos Стойкость к бытовым химикатам	-	conforme conform gleichmässig conforme соответствует	MIN GB	UNI EN ISO 10545-13
	Resistenza agli acidi e alle basi a bassa concentrazione Resistant to acids and low concentration bases Résistance aux acides et aux bases à faible concentration Widerstandsfähig gegenüber niedrig konzentrierten Säuren und Laugen Resistencia a los ácidos y las bases de baja concentración Стойкость к низким концентрациям кислот и щелочей	-	MIN GLB	secondo classificazione prodotto according to product classification selon classification produit Gemäß Produktklassifizierung СООГЛАСНО КЛАССИФИКАЦИИ ПРОДУКЦИИ	UNI EN ISO 10545-13
	Resistenza al gelo Frost resistance Résistance au gel Frostbeständigkeit Resistencia al hielo Морозостойкость	-	resiste resist résiste widerstandsfähig resiste стойкий	richiesta request demande anfrage solicitud требуемое значение	UNI EN ISO 10545-12
	Stabilità dei colori Colour stability Stabilité des coloris Lichtechtheit der Färbung Estabilidad de los colores Цветостойкость	-	stabile stable stable stabil estable стойкий	metodo disponibile available method méthode disponible verfügbare methode método disponible требуемое значение	DIN 51094

gres porcellanato **GS**

smaltato

Tutte le caratteristiche tecniche del gres porcellanato smaltato si associano in questa tipologia, ad una profonda ricerca estetica, che ha sviluppato e realizzato una varietà innumerevole di articoli. Il ciclo produttivo ha raggiunto livelli così sofisticati tali da garantire sia dal punto di vista fisico-chimico che cromatico, la perfetta qualità del prodotto commercializzato.

GLAZED GRES PORCELAIN

All the technical features of the glazed porcelain gres are coupled, in this type of products, with careful aesthetic research, which has led to the development and creation of a wide range of items. The production cycle has reached so refined levels that the final product, both physically-chemically and chromatically, has a perfect quality.

GRES-CERAME EMAILLE

Toutes les caractéristiques techniques du grès cérame émaillé sont associées, dans cette typologie, à une recherche esthétique profonde, qui a permis de développer et de réaliser une grande variété d'articles. Le cycle de la production a atteint des niveaux si élevés qu'il est à même de garantir, aussi bien d'un point de vue physico-chimique et chromatique, la parfaite qualité du produit sur le marché.

GLASIERTES FEINSTEINZEUG

Alle technischen Eigenschaften des zu dieser Typologie gehörenden glasiertes Feinsteinzeuges stützen auf einer aufwendigen, optischen Forschungsarbeit, durch die eine Vielzahl an Artikeln realisiert wurde. Der Produktionszyklus hat derart raffinierte Erzeugnisse ermöglicht, daß sowohl physikalisch-chemisch, als auf farblich, die perfekte Qualität des für den Handel bestimmten Produktes erreicht wurden.

ГЛАЗУРОВАННЫЙ ФАРФОРОВЫЙ КЕРАМОГРАНИТ

Все технические характеристики глазурованного фарфорового керамогранита в данной линии сочетаются с глубокими эстетическими исследованиями, благодаря которым были разработаны и созданы многочисленные изделия. Производственный цикл достиг такого уровня совершенства, который гарантирует, как с физико-химической, так и с цветовой точки зрения, отличное качество поступающей в продажу продукции.



nuove norme ISO

new ISO standards - nouvelles normes ISO - neue ISO normen - nuevas normas ISO - Новые нормы ISO

technical section





DEFINIZIONE E CLASSIFICAZIONE DEFINITION AND CLASSIFICATION - DEFINITION ET CLASSIFICATION DEFINITION UND KLASSIFIZIERUNG - DEFINICIÓN Y CLASIFICACIÓN ОПРЕДЕЛЕНИЕ И КЛАССИФИКАЦИЯ	Tabella 1a Table - Tab. Table - Tabla
CARATTERISTICHE E REQUISITI (specifica tecnica)	GRUPPO - GROUP - GROUPE - GRUPPE - GRUPO - ГРУППА Bla - Blb - Blla - Bllb - Blll ISO 13006
CHARACTERISTICS AND REQUISITES (technical specifications)	Campionamento e criteri di accettazione Sampling and basis for acceptance - Echantillonnage et critères d'acceptation Musterentnahme und Kriterien für die Annahme - Muestreo y criterios de aceptación Отбор образцов и приемочные критерии ISO 10545.1
CARACTERISTIQUES ET QUALITES REQUISES (Spécification technique)	Determinazione delle caratteristiche dimensionali e della qualità della superficie Determination of dimensions and surface quality Détermination des caractéristiques dimensionnelles et de la qualité de la surface Bestimmung der Abmessungseigenschaften und der Qualität der Oberfläche Determinación de las características dimensionales y de la calidad de la superficie Определение размерных характеристик и качества поверхности ISO 10545.2
EIGENSCHAFTEN UND VORAUSSETZUNGEN (technische Beschreibung)	Determinazione dell'assorbimento d'acqua, della porosità apparente della densità relativa apparente e della densità apparente Determination of water absorption, apparent porosity, apparent relative density and bulk density Détermination de l'absorption d'eau, de la porosité apparente, de la densité relative apparente et de la densité apparente Bestimmung der Wasseraufnahme, der scheinbare Porosität, der scheinbaren relativen Dichte und der scheinbaren Dichte Determinación de la absorción de agua, de la porosidad aparente, de la densidad relativa aparente y de la densidad aparente Определение водопоглощения, кажущейся пористости, удельной кажущейся плотности и кажущейся плотности ISO 10545.3
CARACTERÍSTICAS Y REQUISITOS (especificaciones técnicas)	Determinazione della resistenza a flessione e della forza di rottura Determination of modulus of rupture and breaking strength - Détermination de la résistance à la flexion et de la force de rupture Bestimmung der Flexionsfestigkeit und der Bruchkraft - Determinación de la resistencia a la flexión y de la fuerza de rotura. Определение прочности при изгибе и разрушающего усилия ISO 10545.4
ХАРАКТЕРИСТИКИ И ТРЕБОВАНИЯ (технические условия)	Determinazione della resistenza all'urto mediante misurazione del coefficiente di restituzione Determination of impact resistance by measurement of coefficient of restitution Détermination de la résistance au choc à travers la mesure du coefficient de restitution Bestimmung der Stoßfestigkeit durch Messung des Restitutionsfaktors Determinación de la resistencia a los golpes mediante medición del coeficiente de restitución Определение ударпрочности путем измерения коэффициента восстановления ISO 10545.5
METODI DI PROVA TESTING METHODS METHODES D'ESSAI PRÜFMETHODEN MÉTODOS DE PRUEBA МЕТОДЫ ИСПЫТАНИЯ	Determinazione della resistenza all'abrasione profonda per piastrelle non smaltate Determination of resistance to deep abrasion for unglazed tiles Détermination de la résistance à l'abrasion profonde pour carreaux non émaillés Bestimmung der Tiefenabriebfestigkeit bei nicht glasierten Fliesen Determinación de la resistencia a la abrasión profunda para azulejos no esmaltados Определение сопротивления глубокому истиранию неглазурованной плитки ISO 10545.6
* In sede di ISO/TC189 si è deciso di eliminare il metodo di determinazione della durezza superficiale secondo la scala Mohs, previsto dalla norma EN101 e di sostituirlo con un nuovo metodo.	Determinazione della resistenza all'abrasione superficiale per piastrelle smaltate Determination of resistance to surface abrasion for glazed tiles Détermination de la résistance à l'abrasion superficielle pour carreaux émaillés Bestimmung der Oberflächenabriebfestigkeit bei glasierten Fliesen Determinación de la resistencia a la abrasión superficial para azulejos esmaltados Определение сопротивления глазурованной плитки поверхностному истиранию ISO 10545.7
* According to ISO/TC189 the Mohs scale method of determining surface hardness, prescribed by the EN 101 standard, has been eliminated and substituted with a new method.	Determinazione della dilatazione termica lineare Determination of linear thermal expansion - Détermination de la dilatation thermique linéaire Bestimmung der linearen thermischen Dilatation - Determinación de la dilatación térmica lineal. Определение линейного теплового расширения ISO 10545.8
* On a décidé, pour la ISO/TC189, d'éliminer la méthode déterminant la dureté de surface selon l'échelle de Mohs, prévue par la norme EN 101, et de la remplacer par une nouvelle méthode.	Determinazione della resistenza agli sbalzi termici Determination of resistance to thermal shock - Détermination de la résistance aux écarts thermiques Bestimmung der Thermoschockfestigkeit - Determinación de la resistencia a los cambios de temperatura. Определение стойкости к перепадам температуры ISO 10545.9
* Bei der ISO/TC189 wurde beschlossen, die Bestimmungsmethode der Oberflächenhärte auf der Mohsskala gemäss EN 101 abzuschaffen und durch eine andere Methode zu ersetzen.	Determinazione della dilatazione dovuta all'umidità Determination of moisture expansion - Détermination de la dilatation due à l'humidité Bestimmung der Dilatation durch Feuchtigkeit - Determinación de la dilatación debida a la humedad. Определение расширения, вызванного влажностью ISO 10545.10
* En sede de ISO/TC189 se ha decidido eliminar el método de determinación de la dureza superficial según la escala Mohs, previsto por la norma EN 101, y sustituirlo con un nuevo método.	Determinazione della resistenza al cavillo per piastrelle smaltate Determination of crazing resistance for glazed tiles - Détermination de la résistance à la craquelure pour carreaux émaillés Bestimmung der Haarrissfestigkeit bei glasierten Fliesen - Determinación de la resistencia al cuarteado para azulejos esmaltados Определение стойкости глазурованной плитки к образованию кракелюра ISO 10545.11
* При составлении нормы ISO/TC189 было решено устранить метод определения поверхностной твердости по шкале Мооса, предусмотренный стандартом EN101, и заменить его новым методом.	Determinazione della resistenza al gelo Determination of frost resistance - Détermination de la résistance au gel Bestimmung der Frostfestigkeit - Determinación de la resistencia a las heladas Определение морозостойкости ISO 10545.12
Fonte: Assopiastrelle Formedil / Source : Assopiastrelle Formedil / Source : Assopiastrelle Formedil / Quelle: Assopiastrelle Formedil / Fuente: Assopiastrelle Formedil / Источник: итальянская ассоциация производителей керамической плитки Assopiastrelle	Determinazione della resistenza chimica Determination of chemical resistance - Détermination de la résistance chimique Bestimmung der Chemikalienfestigkeit - Determinación de la resistencia química Определение химической стойкости ISO 10545.13
	Determinazione della resistenza alle macchie Determination of resistance to stains - Détermination de la résistance aux taches Bestimmung der Fleckenfestigkeit - Determinación de la resistencia a las manchas Определение стойкости к образованию пятен ISO 10545.14
	Determinazione del piombo e del cadmio ceduto dalle piastrelle smaltate Determination of lead and cadmium given off by glazed tiles Détermination du plomb et du cadmium émanant des carreaux émaillés Bestimmung des von glasierten Fliesen freigesetzten Bleis und Kadmiums Determinación del plomo y del cadmio cedido por los azulejos esmaltados Определение свинца и кадмия, выделяемого глазурованной плиткой ISO 10545.15
	Determinazione delle differenze di colore Determination of colour differences - Détermination de la différence de couleur Bestimmung der Farbunterschiede - Determinación de las diferencias de color Определение цветовых разниц ISO 10545.16
	Determinazione del coefficiente di attrito Determination of coefficient of friction - Détermination du coefficient de frottement Bestimmung des Reibungskoeffizienten - Determinación del coeficiente de rozamiento Определение коэффициента трения ISO 10545.17

caratteristiche tecniche di resistenza allo scivolamento

anti-slip technical features - caractéristiques techniques de résistance au glissement

technische eigenschaften der rutschfestigkeit - características técnicas de resistencia al deslizamiento

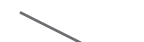
технические характеристики сопротивления скольжению

NORMATIVA TEDESCA DIN 51130 - 51097 GERMAN STANDARD - NORMES ALLEMANDES - DEUTSCHE NORMEN - NORMAS ALEMANAS - НЕМЕЦКИЙ СТАНДАРТ		
DIN 51130	CATEGORIE DI RESISTENZA ALLO SCIVOLAMENTO CON PIEDI CALZATI SLIP RESISTANCE GROUPS WITH FOOTWEAR - CATEGORIES DE RESISTANCE AU GLISSEMENT LES PIEDS CHAUSSÉS RUTSCHHEMMUNGSKATEGORIEN MIT SCHUHWERK - CATEGORIE DI RESISTENZA ALLO SCIVOLAMENTO CON PIEDI CALZATI КАТЕГОРИИ СОПРОТИВЛЕНИЯ СКОЛЬЖЕНИЮ ПРИ ХОЖДЕНИИ В ОБУВИ	
Coefficiente di Attrito Coefficient of friction Coefficient de Friction Reibungskoeffizient Coeficiente de agarre Коэффициент трения	Angoli di Inclinazione Angle Angle d'Inclinaison Neigungswinkel Ángulos de inclinación Углы наклона	Campi di Applicazione Field of application Domaines d'Utilisation Anwendungsbereich Campos de aplicación Сфера применения
R9	 6° ± 10°	Ambienti residenziali, scuole, studi medici, ecc. Residential environments, schools, surgeries, etc. Milieux résidentiels, écoles, cabinets de médecins, etc. Wohnbereich, Schulen, Arztpraxen usw. Ambientes residenciales, escuelas, estudios médicos, etc. Жилые помещения, школы, медицинские амбулатории и т.д.
R10	 10° ± 19°	Toilettes, magazzini, garages cucine di locali pubblici, ecc. Bathrooms, warehouses, garages, kitchens of restaurants, etc. Toilettes, magasins, garages, cuisines d'établissements publics, etc. Toiletten, Lagerhallen, Garagen, Großküchen usw. Baños, almacenes, garajes, cocinas de locales públicos, etc. Туалеты, склады, кухни общественных заведений и т.д.
R11	 20° ± 27°	Lavorazione formaggi, celle frigorifere, lavanderie, ecc. Dairies, cold rooms, laundries, etc. Travail du fromage, chambres frigorifiques, blanchisseries, etc. Käserei, Wäscherei, Kühlräume usw. Elaboración quesos, salas frigoríficas, lavanderías, etc. Сыроваренные цеха, холодильные камеры, прачечные и т.п.
R12	 28° ± 35°	Lavorazione carni, cucine industriali, zuccherifici, ecc. Meat processing, industrial kitchens, sugar production, etc. Travail de la viande, cuisines industrielles, sucreries, etc. Fleischverarbeitungstätten, Industrieküchen, Zuckerfabriken usw. Tratamiento de carnes, cocinas industriales, azucareras, etc. Мясоперерабатывающие цеха, промышленные кухни, сахарные заводы и т.д.
DIN 51097	CATEGORIE DI DESTINAZIONE D'USO PER SUPERFICI CALPESTABILI CON PRESENZA DI ACQUA A PIEDI NUDI SLIP RESISTANCE GROUPS: BAREFOOT ON WET SURFACE - CATEGORIES DE DESTINATION D'UTILISATION POUR SURFACES PIETINABLES EN PRESENCE D'EAU LES PIEDS NUS - BEANSPRUCHUNGSKATEGORIEN FÜR BARFUß BEGEBBARE OBERFLÄCHEN BEI NÄßE CATEGORÍAS DE DESTINO DE USO PARA SUPERFICIES PISABLES CON PRESENCIA DE AGUA CON PIES DESCALZOS КАТЕГОРИИ НАЗНАЧЕНИЯ ПОВЕРХНОСТЕЙ ПРИ НАЛИЧИИ ВОДЫ И ХОЖДЕНИИ БОСИКОМ	
Gruppi di valutazione Evaluation groups Groupes d'estimation Bewertungsgruppen Grupos de valoración Группы оценки	Angoli di Inclinazione Angle Angle d'Inclinaison Neigungswinkel Ángulos de inclinación Углы наклона	Campi di Applicazione Field of application Domaines d'Utilisation Anwendungsbereich Campos de aplicación Сфера применения
A	> = 12%	Spogliatoi, zone di passaggio a piedi nudi, ecc. Dressing rooms, areas likely to be walked on barefoot, etc. Vestiaires, zones de passage les pieds nus, etc. Umkleideräume, Barfuß-Durchgangsbereiche usw. Vestuarios, zonas de paso con pies descalzos, etc. Раздевалки, зоны хождения босиком и т.д.
B	> = 18%	Docce, bordi piscine, ecc. Shower enclosures, swimming pool decks, etc. Douches, bords des piscines, etc. Duschen, Schwimmbadränder usw. Duchas, bordes de piscina, etc. Души, борта бассейнов и т.д.
C	> = 24%	Bordi di piscine in pendenza, scale immerse, ecc. Sloping swimming pool decks, submerged stairs, etc. Bords des piscines en pente, escaliers plongées, etc. Schwimmbadränder mit Gefälle, sich im Wasser befindliche Treppen usw. Bordes de piscina con pendiente, escaleras sumergidas, etc. Наклонные борта бассейнов, погруженные в воду лестницы и т.д.

technical section

massetto di sottofondo e giunti

foundation base and joints - base en ciment et joints - estrich und dehnungsfugen
bloques de fondo y juntas - Подстилающая стяжка и швы

Per superfici da pavimentare molto estese, consigliamo di prestare attenzione alla progettazione delle strutture di sottofondo. Infatti sono da tener conto le seguenti problematiche:

- 1) la dilatazione termica;
- 2) la deformazione o fessurazione dovute al ritiro e asciugamento dei materiali;
- 3) l'assessamento della struttura.

Sottofondi posati in opera su strati comprimibili, esempio isolanti termici, vermiculite o argilla espansa, devono essere armati con rete elettrosaldata. I massetti possono essere eseguiti in due modi: galleggianti o aderenti. Nel primo caso occorre predisporre una barriera al vapore (foglio polietilico) quindi polistirolo di 1 cm lungo i muri perimetrali e lungo qualsiasi altro elemento che attraversa la pavimentazione. I giunti di frazionamento sono consigliati ogni 5x5 m. Nel caso di massetti aderenti occorre pulire la superficie cementizia, quindi applicare una boiaccia di adesione realizzata con cemento, acqua e idonei lattici. Quando quest'ultima è ancora fresca occorre gettare il nuovo massetto aderente. Le informazioni contenute in questo paragrafo sono puramente indicative. Per notizie più approfondite rimandiamo a documentazione specializzata.

For very large floor surfaces we recommend additional care in the design of the foundation structure.

The following factors should be kept in mind:

- 1) Thermal expansion.
- 2) Deformation or cracking caused by shrinkage and drying of the materials.
- 3) The settling of the structure.

Foundations laid on compressible layers, like thermal insulation, vermiculite, or expanded clay must be reinforced with arc-welded meshwork. The base can be made in one of two ways: floating or fixed. In the first case a vapour barrier must be provided (polyethylene sheet) and then polystyrene of 1 cm along the perimeter walls and along any other element that runs across the floor. Sectional joints are recommended every 5x5 m. In the case of fixed bases, clean the cement surface and apply a fixing grout made from cement, water and suitable latex. When this is still fresh, cast the new fixed laying base. The information contained in this paragraph is purely indicative. For more-in-depth information, we refer you to the special documentation.

Si vous devez carreler des surfaces très étendues, nous vous conseillons de faire très attention au projet des structures de la base en ciment.

Il existe, en effet, des problèmes dont vous devez tenir compte:

- 1) la dilatation thermique;
- 2) la déformation ou les fissures provoquées par le retrait et le séchage des matériaux;
- 3) le tassement de la structure.

Les bases qui sont posées sur des couches compressibles comme, par exemple, des couches d'isolement thermique, de la vermiculite ou de l'argile expansée, doivent être armées de filets soudés électriquement. Les bases de ciment peuvent être effectuées de deux façons: ou bien mobiles ou bien adhérentes. Dans le premier cas, vous devez préparer une barrière à la vapeur (feuille de polythène) et, par conséquent, appliquez du polystyrène d'1 cm le long des murs périmétraux et le long de n'importe quel élément qui traverse le carrelage. Les joints de fractionnement sont conseillés tous les 5x5 m. Dans le cas de bases de ciment adhérentes, vous devez nettoyer la surface en ciment, puis appliquer une bouillie d'adhérence réalisée à base de ciment, d'eau et de latex appropriés. Quand celle-ci est encore fraîche, vous devez jeter dessus la nouvelle base adhérente en ciment. Les informations que contient ce paragraphe sont purement indicatives. Pour des renseignements plus approfondis, consultez la documentation spécialisée.

Bei sehr großen Bodenflächen empfehlen wir, in besonderer Weise auf die Vorbereitung des Untergrunds zu achten.

Dabei muss auf folgendes geachtet werden:

- 1) die thermische Dehnung;
- 2) die Verformung und Rissbildung aufgrund von Schwund und Austrocknung der Materialien;
- 3) die Setzung des Untergrunds.

Untergründe, die auf komprimierbaren Schichten wie Wärmedämmungen, Vermiculit oder Leichtton ausgeführt worden sind, müssen durch Stahlmatten verstärkt werden. Der Estrich kann auf zwei verschiedene Weisen verlegt werden: schwimmend oder aufliegend. Im ersten Fall muss eine Dampfsperre (Polyäthylenfolie) verlegt werden; dann 1 cm Styropor die Wände entlang sowie an allen Baukörpern, die den Boden unterbrechen. Zu allen 5x5 m werden Dehnungsfugen empfohlen. Bei aufliegendem Estrich die Zementoberfläche reinigen, dann eine Haftschrämme aus Zement, Wasser und Latex auftragen. Den neuen Estrich ausführen, wenn die Haftschrämme noch frisch ist. Die in diesem Abschnitt enthaltenen Informationen sind vollkommen unverbindlich. Für weitergehende Informationen verweisen wir auf die entsprechende Dokumentation.

Para superficies muy amplias, que se deben pavimentar, aconsejamos prestar atención al proyecto de las estructuras de base.

De hecho se deben tener en cuenta las siguientes problemáticas:

- 1) la dilatación térmica;
- 2) la deformación o fisuración debidas al retiro y secado de los materiales;
- 3) el asentamiento de la estructura.

Las bases colocadas sobre estratos comprimibles, por ejemplo aislantes térmicos, vermiculita, arcilla expandida, deben ser armadas con red electrosoldada. Los bloques de fondo pueden ser realizados de dos maneras: flotantes o adherentes. En el primer caso es necesario disponer una barrera al vapor (folio de polietileno) a continuación colocar el poliestireno de 1 cm a lo largo de las paredes perimetrales y a lo largo de cualquier otro elemento que atraviese el pavimento. Las juntas de fraccionamiento son aconsejables cada 5x5 m. En caso de bloques de fondo adherentes es necesario limpiar la superficie de cemento, después aplicar una lechada de adhesión realizada con cemento, agua y látex idóneo. Cuando ésta última está todavía fresca es necesario echar el nuevo bloque de fondo adherente. Las informaciones contenidas en este párrafo son puramente indicativas. Para informaciones más detalladas ver documentación especializada.

В случае настила больших поверхностей рекомендуем тщательно спроектировать подстилающие слои.

Необходимо учитывать следующие аспекты:

- 1) тепловое расширение;
- 2) искажение или растрескивание, вызванное усадкой и высыханием материалов;
- 3) оседание конструкции.

Подстилающие слои, уложенные на сжимаемые материалы, например теплоизоляционные материалы, вермикулит или керамзит, необходимо армировать электросваренной сеткой. Стяжки бывают двух типов - плавающие или прилегающие. В первом случае необходимо уложить паронепроницаемый барьер (полиэтиленовую пленку), затем 1 см полистирола вдоль периметра стен и вдоль любого другого элемента, проходящего через пол. Рекомендуется выполнить делительные швы через каждые 5 x 5 м. В случае прилегающей стяжки необходимо сначала очистить бетонную поверхность, затем нанести прилипающий раствор, выполненный из цемента, воды и подходящих лактесов. Пока раствор еще не схватился, следует залить прилегающую стяжку. Информация, приведенная в данном разделе, носит лишь ориентировочный характер. Для более подробных сведений смотри специализированную документацию.

posa in opera

laying - pose - verlegung - colocación - Укладка

La posa di un pavimento può avvenire in due sistemi: il primo con una posa a cemento tradizionale, il secondo con l'uso di collanti.

Per il primo caso consigliamo di adottare i seguenti accorgimenti:

- non si deve immergere il materiale in acqua prima della posa;
- spolvero in cemento nella quantità a rifiuto;
- battere il pavimento con l'apposita macchina fino alla fuoriuscita della boiaccia.

Nel secondo caso consigliamo di:

- procedere con l'uso di adesivi;
- preparazione del piano di posa rendendolo sufficientemente planare senza fessurazioni e ben pulito;
- preparazione dell'adesivo attenendosi alle istruzioni del produttore;
- applicazione del collante e posa: applicare con la spatola dentata, coprendo la parte che a mano a mano si va posando.

Le piastrelle andranno appoggiate, con una pressione leggera sulla superficie.

Rimuovere di tanto in tanto per controllare che l'adesivo abbia bagnato sufficientemente il suo rovescio.

Consigliamo sempre una posa con fuga adeguata al tipo di materiale.

Le informazioni contenute in questo paragrafo sono puramente indicative. Per notizie più approfondite rimandiamo a documentazione specializzata.

There are two systems for laying floor tiles: the first with traditional cement, and the second using glue.

In the first case we recommend proceeding as follows:

- do not submerge the material in water before laying,
- sprinkle abundantly with cement,
- pound the floor with an appropriate machine until the grout begins to extrude.

In the case of adhesives we recommend:

- preparing the laying bed so that it is sufficiently flat, free of cracks and very clean,
- prepare the adhesive according to the manufacturer's instructions,
- glue application and laying: apply the glue with a toothed spatula, covering each section as laying proceeds.

The tiles are set in position with a light surface pressure.

We always strongly recommend installation with joints suitable for material being used.

Occasionally remove one to check that the adhesive has sufficiently covered the back of the tile.

The information contained in this paragraph is purely indicative. For more-in-depth information, we refer you to the special documentation.

La pose d'un carrelage peut se faire de deux façons: la première est la pose traditionnelle sur du ciment, la seconde est celle effectuée à l'aide de colles.

Dans le premier cas, nous vous conseillons de faire bien attention aux points suivants:

- vous ne devez pas plonger les carreaux dans de l'eau avant de les poser;
- saupoudrez la bouillie de ciment jusqu'à saturation;
- battez les carreaux à l'aide de la machine conçue à cet effet jusqu'à ce que la bouillie arrive à la surface des carreaux.

Dans le deuxième cas, nous vous donnons les conseils suivants:

- procédez dans l'utilisation des colles;
- préparez la surface sur laquelle les carreaux seront posés: elle doit être suffisamment plate, sans fissures et parfaitement propre;
- préparez la colle en suivant le mode d'emploi du producteur;
- appliquez la colle et posez les carreaux de la façon suivante: à l'aide d'une brosse dentée, appliquez la colle sur la partie de la surface que vous allez recouvrir au fur et à mesure de carreaux.

Posez les carreaux et appliquez une légère pression sur leur surface.

Enlevez un carreau de temps en temps pour vérifier que l'adhésif l'a suffisamment mouillé dessous.

Nous conseillons toujours une pose avec joint adapté au type de matériel.

Les informations que contient ce paragraphe sont purement indicatives. Pour des renseignements plus approfondis, consultez la documentation spécialisée.

Die Verlegung eines Bodenbelags kann mit zwei Systemen erfolgen: das erste ist die herkömmliche Verlegung mit Zementmoertel, das zweite die Verlegung mit Kleber.

Im ersten Fall empfehlen wir die Anwendung der folgenden Maßnahmen:

- Das Material darf vor der Verlegung nicht in Wasser eingetaucht werden.
- Den Untergrund mit reichlich Zement abstreuen.
- Den Bodenbelag mit der entsprechenden Maschine abrütteln, bis die Schlämme austritt.

Im zweiten Fall empfehlen wir:

- Kleber zu verwenden;
- Vorbereitung des Verlegeuntergrunds, der ausreichend eben, frei von Rissen und sauber sein muss;
- Vorbereitung des Klebers unter Beachtung der Angaben des Herstellers;
- Auftragen des Klebers und Verlegung; mit der Zahnspatel auftragen und nach und nach den Bereich abdecken, der verlegt wird.

Die Fliesen werden mit einem leichten Druck auf die Oberfläche aufgesetzt.

Ab und zu eine Fliese abheben, um zu kontrollieren, ob der Kleber die Rückseite in ausreichender Weise angefeuchtet hat.

Es wird empfohlen eine zum Materialtyp passende Fuge zu verwenden.

Die in diesem Abschnitt enthaltenen Informationen sind vollkommen unverbindlich. Für weitergehende Informationen verweisen wir auf die entsprechende Dokumentation.

La colocación de un pavimento puede realizarse con dos sistemas: el primero con una colocación con cemento tradicional, el segundo con el uso de colas.

Para el primero aconsejamos adoptar las siguientes medidas:

- no se debe sumergir el material en agua antes de la colocación;
- esparcir cemento en polvo hasta la saturación;
- batir el pavimento con la máquina especial hasta que salga la lechada.

En el segundo caso aconsejamos:

- proceder con el uso de adhesivos;
- preparación de la base sobre la que se deben colocar los azulejos, rindiéndola suficientemente plana sin fisuraciones y bien limpia;
- preparación del adhesivo ateniéndose a las instrucciones del productor;
- aplicación de la cola y colocación; aplicar con la espátula dentada, cubriendo la parte que poco a poco se va colocando.

Los azulejos se deberán apoyar, con una presión ligera sobre la superficie.

Levantar de vez en cuando un azulejo para controlar que el adhesivo haya mojado suficientemente la parte de atrás.

Las informaciones contenidas en este párrafo son puramente indicativas. Para informaciones más detalladas ver documentación especializada.

Укладка пола может выполняться двумя способами: традиционным образом, с применением цемента, или же с использованием клеящих составов.

При укладке при помощи цемента рекомендуем придерживаться следующих указаний:

- не погружать материал в воду перед укладкой;
- обильно посыпать пол цементом;
- утрамбовать пол специальной машиной вплоть до вытекания цементного молока.

При использовании клеящих составов рекомендуем выполнить следующее:

- использовать клеящие средства;
- подготовить поверхность укладки, обеспечивая ее плоскостность, отсутствие щелей и грязи;
- подготовить клеящий состав с соблюдением инструкции его изготовителя;
- нанесение клея и укладка: нанести средство зубчатым шпателем, укладывая плитку по мере нанесения клея.

Плитку следует укладывать, оказывая небольшое давление на ее поверхность.

Время от времени снимайте плитку и проверяйте, что клей намочил в достаточной степени тыльную сторону плитки.

Рекомендуем всегда укладку со швом, соответствующим типу материала.

Информация, приведенная в данном разделе, носит лишь ориентировочный характер. Для более подробных сведений смотри специализированную документацию.

stuccatura delle fughe

joint sealing - jointoiment - verfugung der fugen - estucado de las fugas - Заделка швов

La stuccatura del pavimento posato dovrà avvenire il giorno seguente la posa "a colla". Le fughe dovranno essere perfettamente pulite in tutto il loro spessore; si deve successivamente inumidire con la spugna il bordo delle piastrelle. La fuga può essere eseguita con stucchi cementizi o epossidici preconfezionati. La stuccatura delle fughe viene effettuata con le apposite spatole di gomma, facendo penetrare con particolare cura lo stucco in profondità evitando i vuoti d'aria che possono crearsi. Si lascia asciugare il tutto e quando il sigillante incomincia a far presa, si procede ad asportare l'eccesso con una spugna umida. Per gli epossidici attenersi alle istruzioni del produttore. Nel caso di gres porcellanato levigato è consigliato per la stuccatura sporcare tutta la superficie della piastrella e non utilizzare una colorazione in contrasto con il colore della piastrella. Le informazioni contenute in questo paragrafo sono puramente indicative. Per notizie più approfondite rimandiamo a documentazione specializzata.

The sealing of the laid floor joints should take place the day after laying with glue. The joints must be perfectly clean right across their width. The edges of the tiles should be dampened with a sponge. Joints can be filled with ready-made cement or epoxy filler. The joints are filled using a special rubber spatula, taking great care to ensure the full penetration of the filler and avoiding the formation of air gaps. Leave to dry, and when the filler begins to set, remove the excess with a damp sponge. With epoxy fillers, follow the manufacturer's instructions. When laying polished porcelain stoneware it is advisable to dirty the entire surface of the tile with the filler and not to use a colour that contrasts with the colour of the tiles. The information contained in this paragraph is purely indicative. For more-in-depth information, we refer you to the special documentation.

Le jointoiment du carrelage posé doit se faire le lendemain de la pose "à la colle". Vous devez d'abord nettoyer parfaitement les joints sur toute leur épaisseur et ensuite humidifier le bord des carreaux à l'aide d'une éponge. Le jointoiment peut être effectué avec des stucs en ciment ou avec des stucs oxycarbonés qui se trouvent dans le commerce déjà préparés. Pour effectuer le jointoiment, vous devez utiliser des brosses spéciales en caoutchouc : faites pénétrer le stuc en profondeur en faisant attention à ce qu'il ne se crée pas de vides d'air. Laissez sécher le tout et, quand le scellant commence à prendre, éliminez le stuc excédant à l'aide d'une éponge humide. Pour les oxycarbonés, conformez-vous au mode d'emploi du producteur. Si le carrelage que vous posez est en grès cérame poli, nous vous conseillons d'enduire toute la surface du carreau quand vous effectuez le jointoiment et de pas utiliser une couleur en contraste avec celle des carreaux. Les informations que contient ce paragraphe sont purement indicatives. Pour des renseignements plus approfondis, consultez la documentation spécialisée.

Das Verfugen des verlegten Bodenbelags muss gleich am ersten Tag der Verlegung erfolgen. Die Fugen müssen in der gesamten Breite vollkommen sauber sein und anschließend muss der Rand der Fliese mit einem Schwamm angefeuchtet werden. Die Fuge kann mit Zementstuck oder gebrauchsfertigem Epoxystuck ausgeführt werden. Das Verfugen der Fugen erfolgt mit entsprechenden Gummispachteln, wobei besonders darauf zu achten ist, dass die Masse in die Tiefe eindringt und dass Hohlräume vermieden werden. Alles antrocknen lassen und die überflüssige Masse mit einem feuchten Schwamm entfernen, wenn sie abzubinden beginnt. Bei Epoxymassen die Anweisungen des Herstellers beachten. Bei geschliffenem Feinsteinzeug wird empfohlen, die gesamte Oberfläche der Fliese zu verschmutzen und zum Verfugen eine Farbe zu verwenden, die nicht im Kontrast zur Fliesenfarbe steht. Die in diesem Abschnitt enthaltenen Informationen sind vollkommen unverbindlich. Für weitergehende Informationen verweisen wir auf die entsprechende Dokumentation.

El estucado del pavimento colocado deberá realizarse al día siguiente de la colocación "pegado". Las fugas deberán estar perfectamente limpias en todo su espesor: sucesivamente se debe humedecer con una esponja el borde de los azulejos. La fuga puede realizarse con estucos de cemento o epoxídicos ya preparados. El estucado de las fugas se efectúa con las espátulas especiales de goma, haciendo, con particular cuidado, que el estuco penetre en profundidad evitando los vacíos de aire que puedan crearse. Se deja secar y cuando la masilla impermeable empieza a agarrar, se procede a retirar el exceso con una esponja húmeda. Para los epoxídicos, atenderse a las instrucciones del productor. En caso de gres porcelánico pulido es aconsejable para el estucado, ensuciar toda la superficie del azulejo y no utilizar una coloración en contraste con el color del mismo. Las informaciones contenidas en este párrafo son puramente indicativas. Para informaciones más detalladas ver documentación especializada.

Заделка уложенного при помощи клея пола должна выполняться на следующий день после укладки. Швы необходимо тщательно очистить по всей толщине, после чего необходимо увлажнить губкой кромку плитки. Шов можно выполнить при помощи уже готовых цементных или эпоксидных затирок. Заделку швов необходимо выполнять при помощи специальных резиновых шпателей, очень тщательно обеспечивая проникновение затирки и не допуская образования воздушных пустот. Выдержать материал и, когда клей начнет схватываться, удалить излишки при помощи влажной губки. При применении эпоксидных материалов придерживайтесь инструкций их изготовителя. Если речь идет о полированном фарфоровом керамограните, то для заделки швов рекомендуется намазать всю поверхность плитки, при чем не следует использовать цветную затирку, цвет которой контрастирует с цветом плитки. Информация, приведенная в данном разделе, носит лишь ориентировочный характер. Для более подробных сведений смотри специализированную документацию.

manutenzione e pulizia di pavimenti e rivestimenti

maintenance and cleaning of floors and walls - entretien et nettoyage des sols et revêtements

instandhaltung und reinigung von fussböden und verkleidungen

чистка и уход за напольной и облицовочной плиткой

- Un pavimento o rivestimento murale Saime Ceramiche sia nella versione naturale che satinata che lappata o lucida, è sinonimo di bellezza, durata e resistenza nel tempo.

La sua manutenzione non richiede particolari cure se non l'attenersi alle seguenti norme di Pulizia.

Prima pulizia

Si esegue normalmente una sola volta prima dell'utilizzo del pavimento/rivestimento e deve essere obbligatoriamente eseguita dopo la posa in opera e prima dell'uso del pavimento/rivestimento. Ha lo scopo di eliminare ogni traccia di cemento o stucco conseguente alla chiusura dei giunti.

Fughe con stucco cementizio - Lavare il pavimento/rivestimento con un detergente specifico a base acida per ceramica (per i rivestimenti usare un detergente specifico acido in gel).

Fughe con stucco epossidico - È necessario non lasciare residui di prodotti a fine lavoro asportando tutto il materiale, anche se disperso in acqua e asciugando la superficie del manufatto. È consigliabile effettuare un lavaggio con appositi detergenti entro 24 ore circa dalla stuccatura e, comunque a stucco indurito all'interno della fuga.

Ovviamente più tempo passa tra la stuccatura già indurita e l'inizio del lavaggio e **più difficoltosa sarà la pulizia.**

Per entrambi i tipi di stucco si procede come di seguito:

1. Spazzare il pavimento/rivestimento raccogliendo lo sporco grossolano.
2. Inumidire con acqua la superficie affinché le fughe vengano impregnate e pertanto protette dall'azione dell'acido del detergente; evitare che il detergente venga a contatto con componenti di acciaio, alluminio e marmo naturale adiacenti al pavimento/rivestimento.
3. Attenersi alla concentrazione del prodotto detergente (rapporto di miscelazione con l'acqua) indicata dal produttore, applicandolo con una spazzola e stenderlo.
4. Durante il tempo d'azione che deve essere stabilito in relazione allo stato del pavimento strofinare lo sporco più ostinato (ad es. residui di malta, stucco, etc...).
5. Sciacquare il pavimento/rivestimento con acqua e raccogliere subito l'acqua sporca (manualmente o con un apparecchio lavasciuga).

L'operazione di prima pulizia, se ritenuto necessario, può essere ripetuta.

Se la prima pulizia viene eseguita dopo che il pavimento/rivestimento è stato usato, sarà bene, prima dell'applicazione del prodotto acido, togliere con appositi detersivi alcalini (**sgrassanti**) eventuali presenze di sostanze grasse o simili (vedi Pulizia ordinaria).

Pulizia ordinaria

Per la pulizia quotidiana è sufficiente lavare il pavimento/rivestimento con acqua e aggiunta di normali prodotti detergenti adatti a pulire superfici ceramiche (per i rivestimenti utilizzare detergenti in gel)

La superficie dei prodotti Saime Ceramiche essendo praticamente inassorbente, non richiede l'applicazione di cere e/o prodotti siliconici di protezione che, al contrario, non devono mai essere usati (possono creare un film superficiale modificando le caratteristiche naturali del grès porcellanato).

Il pavimento deve essere considerato pulito quando riacquista il suo aspetto originario.

Tuttavia in presenza di macchie persistenti e difficili da togliere con la pulizia ordinaria, intervenire con impiego di detersivi più concentrati lasciando agire lo stesso per un adeguato intervallo di tempo e, successivamente, strofinare con più intensità fino a ricondurre le piastrelle all'aspetto originario. Al riguardo è opportuno segnalare che il grès è resistente a qualsiasi sostanza chimica, eccezion fatta per l'acido fluoridrico che attacca tutti i prodotti ceramici e che, quindi, non deve essere utilizzato. Per la pulizia di pavimenti in aree pubbliche si consiglia di intervenire dopo la chiusura dei locali, affinché il pavimento, alla riapertura, sia asciutto; in alternativa isolare il pavimento pulito fino alla sua completa asciugatura.

Superficie lucida e lappata

Com'è noto tutte le superfici lucide subiscono con l'uso un processo di opacizzazione. Nel caso dei prodotti Saime Ceramiche, grazie alle peculiari caratteristiche tecniche, questo processo di opacizzazione è più lento rispetto a qualsiasi altro materiale naturale (marmo, granito, pietre...). Per conservare tuttavia il più a lungo possibile la lucentezza originale del pavimento è bene proteggere l'ingresso del locale pavimentato, specie se questo è in diretta comunicazione con ambienti esterni, con uno zerbino o altri strumenti idonei al fine di trattenerne il più possibile polveri o altre sostanze abrasive al di fuori della pavimentazione.

Una leggera diminuzione della lucentezza, a seguito del primo lavaggio acido del pavimento, deve essere considerata normale, perché dovuta alla eliminazione dei residui degli abrasivi utilizzati nella lavorazione della superficie.

- A Saime Ceramiche floor or wall covering, in the natural, honed, semi-polished or polished version, is synonymous with beauty, durability and resistance over time.

Its maintenance does not require special treatments except for the compliance with the following cleaning rules.

Initial cleaning

This is normally carried out once before the wall/floor tiling is put into use; it must be performed after laying and before using the floor/wall. It aims to remove all traces of concrete or grout following the filling of the joints.

Joints with concrete grout - Wash the floor/wall with a specific acid-based detergent for ceramics (for wall tiles use a specific gel acid detergent).

Joints with epoxy grout - Since no residues must remain after the work, remove all material, even if dispersed in water, and dry the surface of the product. It is advisable to wash with special cleaning agents within 24 hours of grouting and anyway when the grout has hardened in the joint.

Obviously the more time that elapses between the already-hardened grouting and the beginning of the wash, the more the cleaning will be difficult.

For both types of grout proceed as follows:

1. Sweep the wall/floor to collect the coarse debris.
2. Moisten the surface with water so that the joints are impregnated and protected from the action of the acid contained in the detergent; prevent the detergent from coming into contact with steel, aluminium and natural marble components next to the floor/wall.
3. Respect the detergent concentration (mixing ratio with water) indicated by the manufacturer, spreading it with a brush.
4. During the exposure time, which must be determined in relation to the state of the floor, scrub the most stubborn dirt (i.e. mortar and grout residues, etc.).
5. Rinse the floor/wall with water and immediately collect the dirty water (manually or with a washer-dryer).

The first cleaning operation, if deemed necessary, can be repeated.

If the first cleaning is performed after the floor/wall has been used, it is a good idea, before applying the acid product, to remove with alkali detergents (degreasing agents) any greasy substances or similar (see Ordinary cleaning).

Ordinary cleaning

For daily cleaning it is sufficient to wash the floor/wall with water adding normal detergents suitable for cleaning ceramic surfaces (use gel detergents for walls).

The surfaces of Saime Ceramiche products, being practically non-absorbent, do not require the application of waxes and/or silicone products which, on the contrary, must never be used (they can create a surface film, changing the natural characteristics of porcelain tiles).

The floor must be considered clean when it regains its original appearance.

However if there are stains which are persistent and difficult to remove with normal cleaning, intervene by using more concentrated detergent, leaving it on for an adequate time interval and then scrub it more vigorously to bring the tiles back to their original appearance. In this respect it should be noted that stoneware is resistant to any chemical substance with the exception of hydrofluoric acid that attacks all ceramic products and that must therefore never be used.

In order to clean floors in public areas it is advisable to intervene after the closure of the premises, so that the floor is dry at reopening; alternatively close off the clean floor until it is completely dry.

Honed and semi-polished surface

As we know, all glossy surfaces undergo a process of dulling with use. In the case of Saime Ceramiche products, thanks to their special technical characteristics, this dulling process is slower than in any other natural material (marble, granite, stones, etc.). However, to preserve the original gloss of the floor for as long as possible it is a good idea to protect the entrance to the tiled room, especially if it communicates directly with external environments, with a mat or other appropriate means in order to keep dust or other abrasive substances off the floor as much as possible.

- A slight decrease in gloss, following the first acid washing of the floor, must be regarded as normal, because it is due to the removal of abrasive residues used in the processing of the surface.

Un revêtement de sol ou mural Saime Ceramiche en version naturelle, satinato, lappato ou lucido se caractérise par son esthétique, sa longévité et sa résistance dans le temps. Son entretien ne requiert pas de soins particuliers, si ce n'est le respect des règles suivantes en matière de nettoyage.

Nettoyage initial

Il est généralement effectué une seule fois avant l'utilisation du revêtement de sol/mural, et doit obligatoirement être réalisé après la pose et avant l'utilisation du revêtement de sol/mural.

Son but est d'éliminer toute trace de ciment ou tout résidu suite au remplissage des joints.

Jointes ciment - Nettoyer le revêtement de sol/mural avec un produit nettoyant à base acide pour céramique (pour les revêtements muraux, utiliser un gel nettoyant acide spécifique).

Jointes époxy - Aucun résidu de produit ne doit être laissé à l'issue de la pose. Tout résidu, même couvert d'eau, doit être retiré et la surface du revêtement posé doit être séchée. Il est recommandé d'effectuer un nettoyage avec des produits spécifiques dans les 24 heures environ suivant le remplissage des joints, une fois que ceux-ci ont durci.

Bien sûr, plus le temps passe entre le durcissement des joints et le début du nettoyage, plus le nettoyage sera difficile.

Procéder comme indiqué ci-après pour les deux types de joints :

1. Balayer le revêtement de sol/mural en évacuant les saletés les plus grossières.
2. Humidifier la surface avec de l'eau pour imprégner les joints et les protéger de l'action de l'acide du produit nettoyant ; éviter que le produit nettoyant n'entre en contact avec des composants en acier, en aluminium et en marbre naturel adjacents au revêtement de sol/mural.
3. Respecter la quantité de produit nettoyant (rapport de mélange avec l'eau) indiquée par le fabricant et l'appliquer en l'étalant à l'aide d'une brosse.
4. Pendant le temps d'action, à définir en fonction de l'état du sol, frotter les résidus (de mortier, joint, etc.) les plus tenaces.
5. Rincer le revêtement de sol/mural à l'eau et recueillir immédiatement l'eau sale (manuellement ou avec une laveuse-sécheuse de sol).

Si nécessaire, le nettoyage initial peut être répété.

Si le nettoyage initial est effectué alors que le revêtement de sol/mural a déjà été utilisé, il est préférable avant d'appliquer le produit acide d'éliminer les éventuelles substances grasses ou similaires présentes (voir Nettoyage ordinaire) avec des nettoyeurs alcalins (dégraissants) spécifiques.

Nettoyage ordinaire

Pour le nettoyage quotidien, il suffit de nettoyer le revêtement de sol/mural à l'eau, en y ajoutant des produits nettoyants normaux pour surface céramique (pour les revêtements muraux, utiliser des gels nettoyants).

La surface des produits Saime Ceramiche n'étant quasiment pas absorbante, il n'est pas nécessaire d'appliquer des cires et/ou produits silicones de protection ; au contraire, ceux-ci ne doivent jamais être utilisés (car ils peuvent créer une pellicule superficielle et modifier les caractéristiques naturelles du grès cérame).

Le sol est propre lorsqu'il a retrouvé son aspect d'origine.

En présence de taches persistantes et difficiles à éliminer par un nettoyage ordinaire, utiliser des produits nettoyants plus concentrés en les laissant agir pendant un temps adapté, puis frotter avec plus d'intensité jusqu'à ce que les carreaux aient retrouvé leur aspect d'origine. Signalons à ce sujet que le grès est résistant à toute substance chimique, à l'exception de l'acide fluorhydrique qui attaque tous les produits céramiques et ne doit donc pas être utilisé.

Pour le nettoyage des sols des lieux publics, il est conseillé d'intervenir après la fermeture pour que le sol soit sec au moment de la réouverture ; le cas échéant, isoler le sol nettoyé jusqu'à son séchage complet.

Surface lucida et lappata

Comme on le sait, toutes les surfaces brillantes s'opacifient avec le temps. Grâce aux caractéristiques techniques spécifiques des produits Saime Ceramiche, ce processus d'opacification est plus lent par rapport aux autres matériaux naturels (marbre, granit, pierre, etc.). Pour conserver le plus longtemps possible l'éclat du sol, l'entrée du lieu où il a été posé, en particulier s'il communique directement avec l'extérieur, doit être protégée avec un paillason ou d'autres accessoires permettant de retenir un maximum de poussières ou d'autres substances abrasives.

Une légère diminution de l'éclat du sol après le premier nettoyage acide est normale. Elle est due à l'élimination des résidus des abrasifs utilisés pour le traitement de surface.

- Ein Fußboden oder eine Wandverkleidung von Saime Ceramiche ist sowohl in der Matt als auch in der Satinato, Halbpoliert oder Lucido Version Synonym für unvergängliche Schönheit, Dauer und Resistenz. Die Instandhaltung erfordert keine besondere Pflege, die über die folgenden Reinigungsvorschriften hinausgeht.

Erstreinigung

Sie wird normalerweise nur einmal vor dem Gebrauch des Fußbodens/der Verkleidung vorgenommen und muss auf jeden Fall nach der Verlegung und vor dem Gebrauch des Fußbodens/der Verkleidung erfolgen.

Sie dient zur Beseitigung aller durch das Schließen der Fugen entstandenen Zement- und Stuckspuren.

Fugen mit Zementstuck - Den Fußboden/die Verkleidung mit einem speziellen Reinigungsmittel für Keramik auf saurer Basis reinigen (für die Verkleidungen ein spezielles saures Reinigungsgel verwenden).

Fugen mit Epoxystuck - Nach beendeter Arbeit dürfen keine Rückstände des Produkts zurückbleiben und das gesamte Material muss, auch mit Hilfe von Wasser und durch Trocknen der entsprechenden Fläche, entfernt werden.

Es empfiehlt sich innerhalb von circa 24 Stunden nach der Spachtelung eine Reinigung mit den geeigneten Reinigungsmitteln vorzunehmen, jedoch auf jeden Fall erst wenn der Stuck im Innern der Fuge verhärtet ist.

Je mehr Zeit zwischen der schon verhärteten Spachtelung und dem Beginn der Reinigung vergeht umso schwieriger wird die Reinigung.

Bei beiden Stuckarten wird folgenderweise verfahren:

1. Den Fußboden/die Verkleidung säubern und den groben Schmutz entfernen.
2. Die Oberfläche mit Wasser befeuchten, damit die Fugen imprägniert und somit vor der Wirkung des Reinigungsmittels geschützt werden; es muss vermieden werden, dass das Reinigungsmittel mit Stahl-, Aluminiumkomponenten und natürlichem Marmor in der Nähe des Fußbodens/der Verkleidung in Berührung kommt.
3. Die vom Hersteller angegebene Konzentration der Reinigungsprodukts beachten (Mischungsverhältnis mit Wasser) und mit einer Bürste auftragen und verteilen.
4. In der Einwirkungszeit, die auf Grund des Zustand des Fußbodens festzulegen ist, den hartnäckigsten Schmutz aufwischen (z. B. Rückstände von Mörtel, Stuck etc...).
5. Den Fußboden/die Verkleidung mit Wasser nachspülen und das schmutzige Wasser sofort (bei Hand oder mit einem Bodenreiniger und -trockner) entfernen.

Der erste Reinigungsvorgang kann bei Erfordernis wiederholt werden.

Wenn die Erstreinigung nach Benützen des Fußbodens/der Verkleidung erfolgt, ist es sinnvoll vor dem Auftragen des sauren Produkts mit geeigneten alkalischen (entfettenden) Reinigungsmitteln eventuelle Spuren von Fett oder ähnlichem zu entfernen (siehe normale Reinigung).

Normale Reinigung

Für die tägliche Reinigung ist es ausreichend, wenn der Fußboden/die Verkleidung mit Wasser und einem Zusatz von normalen Reinigungsmitteln für Keramikflächen gereinigt wird (für die Verkleidungen Reinigungsgel verwenden).

Die Oberfläche der Produkte von **Saime Ceramiche** ist nicht absorbierend, sie erfordert kein Auftragen von Wachs und/oder schützenden Silikonprodukten, die sogar niemals verwendet werden dürfen (sie können einen Oberflächenfilm erzeugen und so die natürlichen Charakteristiken des Feinsteinzeugs verändern).

Der Fußboden gilt als sauber, wenn er wieder sein ursprüngliches Aussehen hat.

Allerdings ist bei hartnäckigen Flecken, die mit der normalen Reinigung schwer zu entfernen sind, der Gebrauch von stärker konzentrierten Reinigungsmitteln sinnvoll. Man lässt sie ausreichend lang einwirken und wischt anschließend kräftig darüber, bis die Fliesen wieder ihr ursprüngliches Aussehen erhalten. Diesbezüglich muss darauf hingewiesen werden, dass das Steinzeug resistent gegen alle chemischen Substanzen ist, mit Ausnahme von Fluorwasserstoffsäure, die alle Keramikprodukte angreift und deshalb nicht verwendet werden darf.

Für die Reinigung von Fußböden in öffentlichen Bereichen empfiehlt es sich nach Schließen des Lokals zu reinigen, damit er Fußboden bei der nächsten Öffnung trocken ist. Als Alternative kann der saubere Fußboden isoliert werden, bis er vollständig trocken ist.

Lucido und Halbpoliert Flächen

Es ist bekannt, dass bei Gebrauch alle blanken Flächen glanzlos werden. Im Vergleich zu anderen natürlichen Materialien (Marmor, Granit, Stein) wird bei den Produkten **Saime Ceramiche** dieser Prozess verzögert, dank der besonderen technischen Charakteristiken. Um den ursprünglichen Glanz des Fußbodens allerdings so lange wie möglich zu erhalten, besonders wenn er direkt mit Außenbereichen verbunden ist, sollte der Eingang zum Fußboden des Lokals mit einer Fußmatte oder anderen zweckmäßigen Vorrichtungen geschützt werden, um Staub und sonstiges scheuerndes Material nicht auf den Fußboden zu bringen.

Eine leichte Verminderung des Glanzes nach der ersten sauren Reinigung des Fußbodens ist normal, weil sie auf die Beseitigung der Rückstände der bei der Bearbeitung der Oberfläche verwendeten Schleifmittel zurückführbar ist.

- Напольная или облицовочная плитка **Saime Ceramiche**, как в натуральной, так и в сатирированной, шлифованной или полированной версии, является синонимом красоты, долговечности и прочности. Уход за ней не требует выполнения особых действий, кроме соблюдения следующих правил чистки.

Первая чистка

Как правило, она выполняется один лишь раз, до начала использования пола или облицовки, и должна обязательно выполняться после укладки и до начала использования напольной или облицовочной плитки. Ее целью является удаление всех следов цемента или затирки, которые могут остаться после заделки швов.

Швы с цементной затиркой - Промойте пол или облицовку специальным моющим средством на кислотной основе для керамики (для облицовочной плитки используйте специальный кислотный моющий гель).

Швы с эпоксидной затиркой - Необходимо не оставлять остатков продукта после окончания работ, удаляя весь материал, даже если он растворен в воде, вытирая поверхность насухо.

Рекомендуется промывать специальными моющими средствами **в течение приблизительно 24 часов** после затирки, в любом случае, после отвердевания затирки в шве.

Естественно, чем больше времени пройдет между отвердеванием затирки и началом промывки, тем **сложнее будет выполнять чистку**.

Для обоих типов затирки необходимо действовать следующим образом:

1. Подмести пол или очистить щеткой стены, чтобы собрать крупную грязь.
2. Смочить водой поверхность, чтобы пропитались швы, что защитит их от действия кислоты мощного средства. Не допускайте, чтобы моющее средство попадало на элементы из стали, алюминия и натурального мрамора, которые могут находиться рядом с полом или облицовкой.
3. Соблюдайте указанную производителем концентрацию моющего средства (пропорция смешивания с водой), наносите его щеткой и растирайте.
4. В течение времени действия продукта, которое должно быть установлено в зависимости от состояния пола, потрите наиболее стойкую грязь (напр., остатки раствора, затирки и т.д.).
5. Промойте пол или облицовку водой и сразу же соберите грязную воду (вручную или же пылесосом, собирающим жидкости).

В случае необходимости операции первой чистки можно повторить.

Если же первая чистка выполняется после того, как пол или облицовка уже были использованы, то перед нанесением кислотного продукта рекомендуется удалить специальными щелочными моющими средствами (**обезжиривателями**) возможно присутствующие жирные или схожие вещества (см. Обычную чистку).

Обычная чистка

Для выполнения повседневной чистки достаточно промывать пол или облицовку водой, добавляя в нее обычные моющие средства для чистки керамических поверхностей (для чистки облицовочной плитки используйте чистящие гели).

Поверхность продукции **Saime Ceramiche** практически не впитывает воду, поэтому, она **не требует нанесения воска и/или силиконовых защитных продуктов, которые, наоборот, никогда не следует использовать (они могут образовывать пленку на поверхности, изменяя естественные характеристики керамогранита).**

Пол должен считаться чистым, когда он приобретает свой первоначальный вид.

Тем не менее, при наличии стойких и трудновыводимых во время обычной чистки пятен действуйте, используя более концентрированные моющие средства, оставляя их на необходимое время, после чего интенсивно потрите, чтобы вернуть плитке первоначальный вид. В этом плане необходимо указать, что керамогранит является стойким к любому химическому веществу, **кроме фтористоводородной кислоты, которая разрушает все керамические изделия, следовательно, ее нельзя использовать.**

Для чистки полов в общественных местах рекомендуется действовать после закрытия заведения, чтобы в момент открытия пол был сухим. В противном случае пол следует оградить до его полного высыхания.

Полированная и шлифованная поверхность

Как известно, все полированные поверхности, по мере их использования, становятся матовыми. В случае с продукцией **Saime Ceramiche**, благодаря ее особым техническим характеристикам, матовость образуется медленнее, чем на любом другом натуральном материале (мрамор, гранит, камень). Тем не менее, чтобы как можно дольше сохранить первоначальный блеск пола, рекомендуется защитить вход в помещение, в особенности, если оно выходит непосредственно на улицу, ковриком или другими подходящими средствами, чтобы максимально задерживать пыль или другие абразивные вещества и не допускать их попадания на пол.

Легкое уменьшение блеска после первой промывки пола кислотными средствами должно считаться нормальным, потому что это обусловлено удалением остатков абразивных средств, использованных во время обработки поверхности.

condizioni generali di vendita

general sales conditions - conditions générales de vente - allgemeine verkaufsbedingungen

condiciones generales de venta - Общие условия продажи

1. Premessa

Le presenti condizioni generali, salvo eventuali modificazioni o deroghe concordate per iscritto, disciplinano tutti i contratti di vendita fra noi e l'acquirente. Le variazioni delle condizioni generali di vendita, le transazioni e gli abbuoni, anche se effettuati su iniziativa dei nostri agenti, saranno impegnative per noi solo dopo nostra eventuale conferma scritta e comunque limitate ai contratti a cui si riferiscono.

2. Oggetto della fornitura

La fornitura comprende solamente le prestazioni, i materiali ed i quantitativi specificati nella nostra conferma d'ordine o in altre comunicazioni scritte provenienti da noi. Il testo della nostra conferma d'ordine prevarrà, in ogni caso, sul testo difforme dell'eventuale offerta o della ordinazione.

3. Conferma d'ordine

Qualora nella nostra conferma d'ordine esistano differenze nei singoli elementi che la compongono rispetto alle intese od alle ordinazioni, il compratore che non abbia contestato con lettera raccomandata spedita entro dieci giorni dalla ricezione della conferma tali differenze, è tenuto ad accettarla così come è stata redatta.

4. Consegna

La merce, anche se venduta "franco arrivo", o franco domicilio del compratore, viaggia a rischio e pericolo di quest'ultimo ed ogni nostra responsabilità cessa con la consegna al vettore, nei confronti del quale il compratore - effettuate le opportune verifiche - dovrà sporgere eventuali reclami. L'onere dello scarico della merce dai mezzi di trasporto grava sul compratore. Le spedizioni, via mare o via terra, concernenti forniture sull'estero, vengono effettuate in base alle condizioni scelte di volta in volta, riportate negli "INCOTERMS" approvati dalla Camera di Commercio Internazionale nel 1953 e nei successivi.

5. Termini di consegna

Il termine stabilito per la consegna della merce deve intendersi a favore di entrambi i contraenti.

Salvo l'inserimento di particolari clausole, esso deve di norma considerarsi puramente indicativo e non essenziale. Quando siano intervenute modificazioni al contratto, il termine resta prorogato per un periodo uguale a quello inizialmente stabilito. Ogni evento di forza maggiore sospende la decorrenza del termine per tutta la sua durata. Il ritardo nella consegna della merce, dovuto a cause documentate, anche se non espressamente previste, non dà alcun diritto al compratore di chiedere la risoluzione del contratto, indennizzi o risarcimenti.

6. Pagamenti

Il luogo di pagamento è fissato presso la nostra Sede anche nel caso di emissioni di tratte o ricevute bancarie, ovvero di rilascio di effetti cambiari. Il ritardo, anche parziale, del pagamento delle nostre fatture oltre la pattuita scadenza, darà luogo all'immediata decorrenza degli interessi di mora nella misura dei tassi passivi praticati dagli istituti bancari. Inoltre il mancato o ritardato pagamento delle fatture - per qualsivoglia ragione - ci darà diritto, impregiudicata ogni altra iniziativa, di pretendere il pagamento anticipato delle restanti forniture, oppure di ritenere temporaneamente sospeso o definitivamente risolto il contratto e di annullare l'evasione di eventuali altri ordini in corso, senza che il compratore possa avanzare pretese di compensi, indennizzi od altro. Nessuna eccezione, salvo quella di nullità, annullabilità e rescissione del contratto, può essere opposta dall'acquirente, al fine di ritardare od evitare il pagamento.

7. Riserva di Proprietà

Nel caso in cui il pagamento, per accordi contrattuali, debba essere effettuato - in tutto o in parte - dopo la consegna, i prodotti consegnati restano di nostra proprietà fino all'integrale pagamento del prezzo.

8. Garanzia

La nostra garanzia è limitata ai materiali di 1a scelta, con la tolleranza del 5% (cinqueper cento) circa. Qualsiasi garanzia per vizi rimane quindi espressamente esclusa per i materiali di 2a e di 3a scelta o di stock che, come le partite occasionali, si intendono sempre vendute come "viste" e "piaciute".

Le differenze di tonalità non possono essere denunciate come vizio di materiale. Eventuali reclami e contestazioni dovranno essere notificati, a pena di decadenza, a mezzo lettera raccomandata, unicamente presso la nostra Sede, prima della posa in opera del materiale e comunque nei termini di legge. La posa in opera del materiale determina la decadenza dall'azione per vizi tanto palesi che occulti, importando rinuncia implicita alla garanzia di cui all'art. 1490 c.c. In ogni caso la nostra garanzia comprende unicamente la sostituzione del materiale riscontrato difettoso con esclusione di ogni ulteriore e diversa obbligazione.

Non ci assumiamo nessuna responsabilità sull'idoneità del materiale all'uso cui il compratore lo intende destinare e ciò neppure nell'ipotesi che, da parte nostra, vengano forniti suggerimenti o indicazioni circa l'installazione e l'impiego dello stesso.

9. Marchi commerciali

Il distributore deve utilizzare i nomi ed i marchi commerciali, i logos, ed i domini di cui è titolare esclusiva e fa uso la Nuova Riwal Ceramiche S.r.l. al solo fine di pubblicizzare e vendere i prodotti contrattuali. Tanto il nome Riwal Ceramiche quanto ogni altro nome o marchio commerciale, logos e dominio adottati da Nuova Riwal Ceramiche S.r.l. non dovranno comparire nella ditta, nella ragione sociale o denominazione sociale o nell'oggetto sociale del distributore anche in combinazione di parole. Il distributore non depositerà o farà depositare né userà in alcun modo marchi, nomi, o altri segni distintivi che assomiglino graficamente, foneticamente o in qualsiasi altro modo ai marchi e nomi commerciali che fanno capo alla Nuova Riwal Ceramiche S.r.l. e si asterrà da qualsiasi comportamento che possa comunque arrecare pregiudizio alla Nuova Riwal Ceramiche S.r.l.

10. Foro competente

Per qualsiasi controversia, comunque relativa alla fornitura, tanto da parte del venditore come da parte del compratore, viene attribuita competenza, con applicazione della legge italiana, al tribunale di Modena.

11. Clausola arbitrale

Per le forniture all'estero, tutte le controversie eventualmente derivanti dal contratto, saranno risolte in via definitiva secondo il regolamento di conciliazione e di arbitrato della Camera di Commercio Internazionale da uno o più arbitri, in conformità a detto regolamento. Ferme le condizioni generali che precedono, il diritto sostanziale applicabile sarà quello esclusivamente italiano.

1. Premise

These general conditions, unless modified or extended and then expressly agreed upon in writing, shall govern all the sales agreements between Gruppo RI.WAL Ceramiche and the purchasers. All transactions, variations to the general sales conditions, as well as discounts, even if such offers are made by our agents, shall be binding for RI.WAL only after its written confirmation and, in any case, shall be limited by the agreements they refer to.

2. Supply

The supply includes the services, the materials and the quantities stipulated in our order acknowledgement or in other means of written communication provided by RI.WAL. However, the text of our order confirmation will supersede any different text contained in the previous offer or order.

3. Order confirmation

If there are any differences between the elements in the order confirmation and those in the order or those agreed beforehand and the purchaser does not object to them within 10 days by means of a recorded delivery letter, this latter shall be obliged to accept the order confirmation as it stands.

4. Delivery

The goods, even if sold "free at destination" i.e. with carriage to the purchaser paid, shall travel at this latter's risk and all our responsibilities towards the purchaser cease when the goods are handed over to the carrier, to whom the purchaser, after carrying out the necessary checks, should make any claims. It is the purchaser's duty to unload the goods from the means of transport. Any deliveries made, either by sea or by land, to purchasers abroad are made under the conditions chosen on each occasion, indicated by the 'Incoterms' and subsequent amendments as approved by the International Chamber of Commerce in 1953.

5. Delivery terms

The terms established for the delivery of the goods must be considered beneficial to both parties. Unless extra clauses are provided for, it is standard to consider the terms as simply indicative and not binding. When the agreement is modified, the term is extended by the same amount of time as originally set. In any events of circumstances beyond our control, the delivery term will be suspended for the entire duration of such events. Delays in delivery whose causes can be proved by documentation, even though not expressly provided for, do not result in the purchaser's right to terminate the contract, or to apply for indemnities or damages.

6. Payments

The place of payment is fixed as our head office, even if bank drafts or receipts or bills of exchange are issued. Delays, even partial, in the payment of our invoices (as per the expiry terms agreed upon) shall result in the immediate application of arrears interest, which shall be calculated according to the current bank overdraft rates. Furthermore, failure to pay or delays in payment of the invoices - for any reason - shall give us the right, with no prejudice to further actions, to claim advanced payment for the rest of the supply, or to consider the agreement suspended temporarily or terminated definitively and to annul all orders being processed at that time, without the purchaser being entitled to compensation, indemnities or suchlike. No exceptions, except the rights to nullity and to terminate and withdraw from the agreement, can be opposed by the purchaser in order to delay or avoid payment.

7. Property conditions

If, through contractual agreements, the payment must be made, either in part or in full, after delivery, the products delivered, remain our property until the payment has been made in full.

8. Guarantee

Our guarantee is limited to the 1st choice materials, with a tolerance of approximately 5% (five percent). Any guarantee for defects is therefore expressly excluded for 2nd and 3rd choice materials or discounted stock which, as occasionally happens, are always sold as 'seen and approved'. Tonal differences cannot be disputed as material defects.

Any claims or complaints must be made in writing, at the risk of forfeiture, and they must be sent via recorded delivery mail to our head offices only. This must be done before the material is laid, within the terms set by law. The laying of the material represents the forfeiture of the right to claim for defects, both clearly visible ones and hidden ones, resulting in the implicit waiving of the guarantee as per article 1490 of the Italian Civil Code. In any case, our guarantee only extends to the replacement of the materials found to be faulty, with the exclusion of any further or different obligation.

We cannot accept any responsibility regarding the suitability of the material for the use to which the purchaser puts it, not even if we supply the material with indications or suggestions concerning the installation and use of the material itself.

9. Competent authority

For any disputes, relating to the supply, either from the seller or the buyer, shall be dealt with by the court of Modena and the case shall be governed by the Italian law.

10. Arbitration clause

For foreign supplies, any disputes which may arise from the agreement shall be resolved definitively according to the regulations of conciliation and arbitration of the International Chamber of Commerce, by one or more arbitrators, in compliance with the said regulations. The aforementioned general conditions accepted, the Italian law shall govern this agreement.

11. Commercial Trademarks

The distributor must only use the names, the commercial trademarks, the logos, and the dominion of Nuova Riwal Ceramiche S.r.l., who has the exclusive rights with regards to their use, for the publicising and sale of its contractual products. Both the name Riwal Ceramiche as well as every other name, commercial trademark, logo, dominion or mixture of these words adopted by Nuova Riwal Ceramiche S.r.l. must not appear in the company style, the corporate or in the social name or in the company aim of the distributor. The distributor will not use, deposit or allow the filing of the trademarks, names, or other distinctive signs that resemble graphically, phonetically or in any other way the trademarks and commercial names which are owned by Nuova Riwal Ceramiche S.r.l. and he will forgo any behaviour that may cause harm to Nuova Riwal Ceramiche S.r.l.

condizioni generali di vendita

general sales conditions - conditions générales de vente - allgemeine verkaufsbedingungen

condiciones generales de venta - Общие условия продажи

1. Avant-propos

Les présentes conditions générales de vente disciplinent tous les contrats de vente entre l'acheteur et nous, sauf éventuelles modifications ou dérogations fixées par écrit. Les changements de ces conditions de vente, les transactions et les rabais, même s'ils sont effectués par initiative de nos agents, ne nous engagent qu'après une confirmation écrite de notre part et sont en tout cas limités aux contrats auxquels ils se réfèrent.

2. Objet de la fourniture

La fourniture comprend uniquement les services, les matériaux et les quantités qui sont spécifiés dans notre confirmation de commande ou dans d'autres communications écrites venant de nous. Le texte de notre confirmation de commande prévaudra, de toute façon, sur le texte éventuellement différent de l'offre ou de la commande.

3. Confirmation de commande

Si dans notre confirmation de commande il existe des différences dans les parties qui la composent par rapport aux accords ou aux commandes, l'acheteur qui n'a pas contesté ces différences par lettre recommandée dans les dix jours à compter de la date de réception de la confirmation est tenu à l'accepter telle qu'elle a été écrite.

4. Livraison

La marchandise voyage aux risques et périls de l'acheteur, même si elle est vendue "franco arrivée" ou "franco domicile de l'acheteur" et notre responsabilité cesse à partir du moment où nous remettons la marchandise au transporteur. C'est à ce dernier que l'acheteur devra faire d'éventuelles réclamations après avoir effectué les vérifications appropriées. Les frais de déchargement de la marchandise des moyens de transport sont à la charge de l'acheteur. Les expéditions par mer ou par terre des fournitures vers l'étranger sont effectuées sur la base des conditions choisies à chaque fois parmi celles indiquées dans les "INCOTERMS" approuvées par la Chambre de Commerce Internationale en 1963 et dans les suivantes.

5. Délais de livraison

Le délai établi pour la livraison de la marchandise doit s'entendre en faveur des deux contractants. A part l'introduction de clauses particulières, il doit être considéré normalement comme purement indicatif et non essentiel. Si le contrat a subi des modifications, le délai est prorogé d'une période égale à celle établie initialement. Tout événement de force majeure suspend le point de départ du délai pour toute sa durée. Tout retard dans la livraison de la marchandise dû à des causes documentées, même si elles n'ont pas été expressément prévues, ne donne aucun droit à l'acheteur de demander la résiliation du contrat, des indemnisations ou des dédommagements.

6. Paiements

Le lieu de paiement est le siège de notre société, même en cas d'émission de traites ou de récépissés sur banque, c'est-à-dire de remise de lettres de change. Le retard, même partiel, du paiement de nos factures par rapport au délai convenu, donnera lieu à l'immédiat démarrage du calcul des intérêts moratoires dans la mesure des taux passifs pratiqués par les établissements bancaires. En outre, le non-paiement ou le retard dans le paiement des factures - quelle qu'en soit la raison - nous donnera le droit, toute autre initiative étant en suspens, de prétendre le paiement anticipé des autres fournitures, ou bien de considérer temporairement suspendu ou définitivement résilié le contrat et d'annuler l'expédition des autres commandes éventuellement en cours, sans que l'acheteur puisse avancer des prétentions de dédommagements, d'indemnisations ou autres. Aucune exception, sauf celle de nullité, d'annulation et de résiliation du contrat, ne peut être opposée par l'acheteur pour retarder ou éviter le paiement.

7. Réserve de propriété

Si, suite à des accords contractuels, le paiement doit être effectué - totalement ou partiellement après la livraison, nous restons propriétaires des produits livrés jusqu'au paiement intégral du prix.

8. Garantie

Notre garantie est limitée aux matériaux de 1er choix, avec une tolérance de 5% (cinq pour cent) environ. Toute garantie pour des défauts reste donc expressément exclue pour des matériaux de 2e et de 3e choix ou pour des stocks qui, comme les lots occasionnels, s'entendent toujours vendus tels quels. Les différences de nuances ne peuvent être considérées comme défauts du matériau. Les réclamations et contestations éventuelles doivent être notifiées, sous peine de déchéance, par lettre recommandée, envoyée à l'adresse de notre société, avant que le matériau ne soit posé et en tout cas dans les termes de la loi. La pose du matériau implique la déchéance de l'action pour défauts, aussi bien visibles que cachés, et comporte le renoncement implicite à la garantie visée par l'art. 1490 du code civil italien.

Quoi qu'il en soit, notre garantie ne comprend que le remplacement du matériau défectueux et n'inclut aucune autre obligation. Nous déclinons toute responsabilité sur l'adaptabilité du matériau à l'usage que l'acheteur veut en faire, même dans le cas où nous aurions nous-mêmes donné des conseils ou des indications sur l'installation et l'emploi du matériau.

9. Tribunal compétent

Pour tout différend relatif à la fourniture, aussi bien de la part du vendeur que de la part de l'acheteur, c'est au tribunal de Modène qu'est attribuée la compétence en conformité avec la loi italienne.

10. Clauses d'arbitrage

Pour les fournitures à l'étranger, tous les différends dérivant éventuellement du contrat seront résolus d'une manière définitive suivant le règlement de conciliation et d'arbitrage de la Chambre de Commerce Internationale par un ou plusieurs arbitres, en conformité avec ledit règlement. Les conditions générales qui précèdent restant entendues, le droit substantiel applicable sera exclusivement le droit italien.

11. Marques commerciales

Le distributeur doit utiliser les noms et les marques commerciales, les logos et les domaines dont la société Nuova Riwal Ceramiche S.r.l. est propriétaire et qu'elle emploie, uniquement dans le but de publier et de vendre les produits contractuels. Le nom de Riwal Ceramiche ainsi que tout autre nom ou marque commerciale, logos et domaine adoptés par Nuova Riwal Ceramiche S.r.l. ne devront comparaître dans le nom de la firme, la raison sociale, la dénomination sociale ou dans l'objet social du distributeur, même dans une combinaison de mots. Le distributeur ne pourra déposer, faire déposer ou utiliser de quelque manière que ce soit des marques, noms ou autres signes distinctifs qui ressemblent graphiquement, phonétiquement ou de toute autre façon aux marques et noms commerciaux appartenant à Nuova Riwal Ceramiche S.r.l. Il s'abstiendra en outre de tout comportement pouvant porter préjudice de quelque façon que ce soit à Nuova Riwal Ceramiche S.r.l.

1. Vorbemerkung

Die vorliegenden Allgemeinen Bedingungen regeln vorbehaltlich schriftlich vereinbarter Änderungen oder Abweichungen alle Verkaufsverträge zwischen uns und dem Käufer. Die Änderungen der Allgemeinen Verkaufsbedingungen, die Transaktionen und die Gutschriften sind - auch falls sie auf Veranlassung unserer Handelsvertreter vorgenommen werden - nur dann für uns verbindlich, falls sie von uns schriftlich bestätigt worden sind, und sind in jedem Fall ausschließlich auf die Verträge beschränkt, auf die sie sich beziehen.

2. Gegenstand der Lieferung

Die Lieferung umfasst nur die auf unserer Auftragsbestätigung oder sonstigen schriftlichen Mitteilungen von uns aufgeführten Leistungen, Materialien und Mengen. Der Text unserer Auftragsbestätigung hat in jedem Fall Vorrang vor dem gegebenenfalls abweichenden Text des Auftrags oder der Bestellung.

3. Auftragsbestätigung

Falls unsere Auftragsbestätigung bei einzelnen Positionen, aus denen sie sich zusammensetzt, Abweichungen von den Vereinbarungen oder den Bestellungen aufweist, so ist der Käufer, der diese nicht innerhalb von zehn Tagen per Einschreiben bestatet, gehalten, diese so, wie sie aufgesetzt worden sind, zu akzeptieren.

4. Lieferung

Die Ware reist auf Risiko und Gefahr des Käufers, auch falls sie "frei Bestimmung" oder "frei Haus des Käufers" verkauft wird und unsere Haftung endet mit der Auslieferung an den Transportunternehmer, bei dem der Käufer - nach Durchführung der entsprechenden Überprüfungen - eventuelle Beanstandungen geltend machen muss. Das Abladen der Ware von den Transportfahrzeugen geht zu Lasten des Käufers. Die Lieferungen ins Ausland auf dem See- oder Landweg werden auf Grundlage von von Mal zu Mal ausgewählten Bedingungen ausgeführt, die in den von der Internationalen Handelskammer 1953ff. anerkannten "INCOTERMS" angegeben werden.

5. Lieferfristen

Die Frist, die für die Lieferung der Ware vereinbart wird, ist zu Gunsten beider Vertragspartner auszulegen. Vorbehaltlich der Aufnahme besonderer Klauseln ist sie als unverbindlich und nicht wesentlich anzusehen. Bei Änderungen des Vertrages wird die Frist um einen Zeitraum verlängert, der dem ursprünglich vereinbarten entspricht. Bei Fällen von höherer Gewalt wird die Frist für deren gesamte Dauer ausgesetzt. Diese verspätete Lieferung der Ware, die auf dokumentierten, auch nicht ausdrücklich vorgesehenen Ursachen beruht, berechtigt den Käufer nicht zur Auflösung des Vertrages oder zu Entschädigungsforderungen.

6. Bezahlung

Der Ort der Bezahlung wird auf unseren Firmensitz festgelegt, auch im Falle der Ausstellung von Tratten, Bankquittungen oder Wechslen. Bei - auch partieller - Verspätung der Bezahlung unserer Rechnungen über die vereinbarte Fälligkeit hinaus werden mit unmittelbarer Wirkung Säumniszinsen in Höhe des von den Bankinstituten angewendeten Passivzinssatzes fällig. Außerdem berechtigt uns die unterlassene oder verspätete Bezahlung der Rechnungen - aus jedem beliebigen Grund - und unbeachtet aller weiteren Schritte, die Vorauszahlung der verbleibenden Lieferungen zu fordern oder den Vertrag für vorübergehend oder endgültig ausgesetzt zu betrachten und die Ausführung eventueller sonstiger laufender Bestellungen zu annullieren, ohne dass in diesem Fall Schadensforderungen oder sonstige Forderungen geltend gemacht werden können. Vorbehaltlich der Nichtigkeit, der Annullierbarkeit und des Rücktritts vom Vertrag können vom Käufer keine Ausnahmen für die Verspätung oder Unterlassung der Bezahlung vorgebracht werden.

7. Eigentumsvorbehalt

Falls die Bezahlung den vertraglichen Vereinbarungen gemäß - ganz oder teilweise - nach der Lieferung zu erfolgen hat, so bleiben die gelieferten Produkte unser Eigentum bis zur vollständigen Bezahlung des Preises.

8. Garantie

Unsere Garantie ist auf die Materialien 1. Wahl beschränkt, mit einer Toleranz von ca. 5% (fünf Prozent). Bei Materialien 2. und 3. Wahl sowie bei Lagerbeständen, die wie gelegentliche Partien stets als "gesehen" und "gefallen" verkauft werden, ist jede Garantieleistung für Mängel ausgeschlossen. Tonabweichungen können nicht als Mängel geltend gemacht werden. Eventuelle Reklamationen und Beanstandungen müssen vor der Verlegung des Materials und vor Ablauf der gesetzlichen Frist per Einschreiben einzig und allein an unseren Firmensitz gemeldet werden, andernfalls verfällt der Gewährleistungsanspruch. Die Verlegung des Materials führt zum Verfall des Gewährleistungsanspruches für offensichtliche und versteckte Mängel und führt gemäß § 1490 des ital. Bürgerlichen Gesetzbuches zu einem impliziten Verzicht auf den Garantieleistungsanspruch. In jedem Fall umfasst unsere Garantie ausschließlich die Ersetzung des mangelhaften Materials und alle weiteren Verpflichtungen sind ausgeschlossen. Wir übernehmen keinerlei Haftung für Eignung des Materials für die vom Käufer vorgesehene Verwendungsweise, auch dann nicht, wenn unsererseits Empfehlungen oder Angaben zur Verwendung desselben gemacht werden.

9. Gerichtsstand

Sämtliche Rechtssachen zwischen dem Verkäufer und dem Käufer, die sich auf die Lieferung beziehen, unterliegen der italienischen Rechtsprechung; Gerichtsstand ist Modena.

10. Schiedsklausel

Bei Lieferungen ins Ausland werden sämtliche Rechtssachen, die aus dem Vertrag entstehen, in definitiver Weise auf Grundlage der Schlichtungsbestimmungen der Internationalen Handelskammer von einem oder mehreren Schlichtern entschieden. Unter Beibehaltung der vorausgehenden Allgemeinen Bedingungen ist im wesentlichen das italienische Recht anwendbar.

11. Handelsmarken

Der Händler darf die Namen, Handelsmarken, Logos sowie Domänen, deren ausschließlicher Inhaber und Benützer Nuova Riwal Ceramiche S.r.l. ist, ausschließlich für die Werbung sowie für den Verkauf der Vertragsprodukte verwenden. Sowohl der Name Riwal Ceramiche, als auch alle anderen von Nuova Riwal Ceramiche S.r.l. verwendeten Namen, Handelsmarken, Logos und Domänen dürfen nicht im Namen, der Geschäftsbezeichnung oder im Geschäftszweck des Händlers erscheinen, auch nicht in Wortkombinationen. Der Händler hinterlegt keine Marken, Namen oder sonstige Kennzeichnungen, die den Handelsnamen und -marken von Nuova Riwal Ceramiche S.r.l. auf grafische, phonetische oder sonstige Weise ähnlich sind und er vermeidet sämtliche Verhaltensweisen, die Nuova Riwal Ceramiche S.r.l. schädigen könnten.

condizioni generali di vendita

general sales conditions - condiciones générales de vente - allgemeine verkaufsbedingungen

condiciones generales de venta - Общие условия продажи

1. Premisa

Las presentes condiciones generales, salvo eventuales modificaciones o derogas acordadas por escrito, reglamentan todos los contratos de venta entre el comprador y Riwal (vendedor). Las variaciones de las condiciones generales de venta, las transacciones y los descuentos, deberá presentar eventuales reclamaciones. El coste de la descarga de la mercancía de los medios de transporte corre a cargo del comprador. Los envíos, por mar o por tierra, concernientes a suministros al extranjero, se efectúan en base a las condiciones elegidas cada vez, citadas en los "INCOTERMS", aprobados por la Cámara de Comercio Internacional en 1953 y en los sucesivos.

2. Objeto del suministro

El suministro incluye solamente las prestaciones, los materiales y las cantidades especificadas en nuestra confirmación de pedido o en otras comunicaciones escritas por nosotros. El texto de nuestra confirmación de pedido prevalecerá, en todo caso, sobre el texto diferente de la eventual oferta o del pedido.

3. Confirmación del pedido

En caso de que en nuestra confirmación de pedido existan diferencias en los elementos individuales que la componen respecto a los acuerdos o a los pedidos, el comprador que no haya notificado con carta certificada enviada antes de diez días a partir de la recepción de la confirmación dichas diferencias, deberá aceptarla tal y como ha sido redactada.

4. Entrega

La mercancía, también si se ha vendido "franco llegada", o franco domicilio del comprador, viaja bajo la responsabilidad de éste último y toda responsabilidad nuestra cesa en el momento de la entrega al transportista, frente al cual, el comprador, efectuadas las oportunas verificaciones, deberá presentar eventuales reclamaciones. El coste de la descarga de la mercancía de los medios de transporte corre a cargo del comprador. Los envíos, por mar o por tierra, concernientes a suministros al extranjero, se efectúan en base a las condiciones elegidas cada vez, citadas en los "INCOTERMS", aprobados por la Cámara de Comercio Internacional en 1953 y en los sucesivos.

5. Plazos de entrega

El plazo establecido para la entrega de la mercancía debe considerarse a favor de ambos contratantes. Salvo la introducción de cláusulas particulares, esto debe considerarse por norma puramente indicativo y no esencial. Cuando se hayan realizado modificaciones en el contrato, el plazo resta prorrogado por un periodo igual al establecido inicialmente. Cualquiera situación de fuerza mayor suspende el inicio del plazo durante toda la duración de la misma. El retraso en la entrega de la mercancía, debido a causas documentadas, aunque no estén expresamente previstas, no da ningún derecho al comprador a solicitar la escisión del contrato, indemnizaciones o rescancamientos.

6. Pagos

El lugar de pago queda fijado en nuestra Sede, también en caso de emisión de libranzas o de letras de cambio, o en caso de emisión de otros efectos.

El retraso, aunque parcial, del pago de nuestras facturas más allá del plazo acordado, dará lugar al inicio inmediato de la aplicación de los intereses de demora en la medida de las tasas pasivas practicadas por los institutos bancarios. Además la ausencia o el retraso del pago de las facturas, por cualquier razón, nos dará derecho, pendientes de cualquier otra iniciativa, a pretender el pago anticipado de los restantes suministros, o a considerar temporalmente suspendido o definitivamente rescindido el contrato y a anular la evasión de otros eventuales pedidos en curso, sin que el comprador pueda presentar reclamaciones de compensaciones, indemnizaciones u otros. Ninguna excepción, salvo la de la nulidad, anulabilidad, y rescisión del contrato puede ser opuesta al comprador, con el fin de retrasar o evitar el pago.

7. Reserva de Propiedad

En caso de que el pago, por acuerdos contractuales, deba ser efectuado, en todo o en parte, después de la entrega, los productos entregados permanecen de nuestra propiedad hasta el pago integral del precio.

8. Garantía

Nuestra garantía está limitada a los materiales de 1° calidad, con la tolerancia del 5% (cinco por ciento) aproximadamente. Toda garantía por defectos queda expresamente excluida para los materiales de 2° y 3° calidad o en stock que, como los lotes ocasionales, se consideran siempre vendidos como "vistos" y "aceptados". Las diferencias de tonalidad no pueden ser denunciadas como defectos del material. Eventuales reclamaciones y quejas deberán notificarse, so pena de caducidad, trámite carta certificada, únicamente en nuestra Sede, antes de la colocación del material y, en todo caso, según la ley. La colocación del material determina la caducidad de la acción por defectos tanto evidentes como ocultos, comportando la renuncia implícita a la garantía según el art. 1490 del código civil italiano. En todo caso nuestra garantía incluye únicamente la sustitución del material defectuoso con exclusión de cualquier ulterior obligación. No asumimos ninguna responsabilidad sobre la idoneidad del material para el uso al que el comprador pretende destinarlo y esto ni siquiera en la hipótesis en la que, por parte nuestra, se den sugerencias o indicaciones sobre la instalación y el propio uso.

9. Foro competente

Para cualquier controversia, en todo caso, relativa al suministro, tanto por parte del vendedor como por parte del comprador, se atribuye competencia, con aplicación de la ley italiana, al Tribunal de Modena.

10. Cláusula arbitral

Para el suministro al extranjero, todas las controversias derivadas eventualmente del contrato, serán resueltas por vía definitiva según el reglamento de conciliación y de arbitraje de la Cámara de Comercio Internacional por uno o más árbitros, de acuerdo con dicho reglamento. Manteniendo las condiciones generales que preceden, el derecho sustancial aplicable será exclusivamente el italiano.

11. Marcas comerciales

El distribuidor debe utilizar los nombres y las marcas comerciales, los logotipos, y los dominios de los que es titular exclusiva y usa Nuova Riwal Ceramiche S.r.l. con el único objetivo de hacer publicidad y vender los productos contractuales. Tanto el nombre Riwal Ceramiche como cualquier otro nombre o marca comercial, logotipo y dominio adoptados por Nuova Riwal Ceramiche S.r.l. no deberán aparecer en la empresa, razón social, denominación social o en el objeto social del distribuidor, tampoco en combinación de palabras. El distribuidor no depositará o hará que se deposite ni usará de ninguna manera marcas, nombres u otras señales distintivas que asemejen gráficamente, fonéticamente o en cualquier otro modo a las marcas y nombres comerciales que pertenecen a Nuova Riwal Ceramiche S.r.l. y se abstendrá de todo comportamiento que pueda, de alguna manera, acarrear un perjuicio a Nuova Riwal Ceramiche S.r.l.

1. Предусловие

Следующие общие условия, за исключением возможных письменно согласованных изменений или отклонений, регулируют все контракты о продаже, заключенные между нами и покупателями. Изменения общих условий продажи, мировые сделки и скидки, даже если они предложены нашими агентами, являются для нас обязывающими только после нашего письменного подтверждения, и в любом случае их действие ограничивается контрактами, к которым они относятся.

2. Предмет поставки

Поставка включает в себя лишь только услуги, материалы и количества, указанные в нашем подтверждении заказа или в других изданных нами письменных документах. В любом случае, текст нашего подтверждения заказа преобладает над отличающимся от него текстом возможного предложения или заказа.

3. Подтверждение заказа

Если отдельные составляющие элементы подтверждения заказа отличаются от договоренностей или от заказов, покупатель должен отказаться от таких отклонений заказным письмом в течение десяти дней после получения подтверждения заказа. В противном случае, он обязан согласиться с редакцией подтверждения заказа.

4. Доставка

Даже если товар был продан на условиях "франко место назначения" или франко место нахождения покупателя, он перевозится под ответственностью последнего, при чем любая наша ответственность прекращается в момент передачи товара грузоперевозчику. Поэтому, после выполнения необходимой проверки, покупатель должен выставлять претензии только грузоперевозчику. Расходы по разгрузке товара с транспортного средства лежат на покупателе. Отгрузка сухопутным или морским путем международных поставок выполняется на основе выбранных в каждом отдельном случае условий, исходя из правил "ИНКОТЕРМС", одобренных международной Торговой палатой в 1953 году и из последующих изданий.

5. Сроки поставки

Срок, согласованный для доставки товара, должен толковаться в пользу обеих договаривающихся сторон. При отсутствии специальных оговорок, как правило, этот срок считается лишь ориентировочным и не существенным. В случае внесения изменений в контракт, срок отодвигается на период, равняющийся ранее согласованному сроку. Каждое форс-мажорное обстоятельство, во время его действия, прекращает отсчет срока. Задержка в поставке товара, если она вызвана уважительными причинами, даже не специально предусмотренными, не дает покупателю право требовать расторжения контракта, компенсации или возмещения убытков.

6. Оплата

Место произведения оплаты - это адрес нашей компании, даже в случае выставления тратт или предьявительских тратт, или же выдачи векселей. Задержка, даже частичная, в оплате наших инвойсов сверх согласованного срока вызывает немедленное начисление процентов по просроченной задолженности в размере процентной ставки на заемный капитал, взимаемой банковскими учреждениями. Кроме того, невыплата или задержка в выплате инвойсов (по каким то ни было причинам) дает нам право, помимо всего прочего, требовать досрочную оплату оставшихся поставок, или считать контракт временно или окончательно расторгнутым, невыполнять возможно имеющиеся другие заказы, при чем покупатель не имеет права требовать компенсацию, возмещение убытков или прочие требования. В целях задержки или уклонения от выплаты покупатель не может выставлять никакое возражение, кроме недействительности, оспоримости и расторжения контракта.

7. Право собственности

В случае, если по контрактной договоренности оплата будет полностью или частично производиться после доставки, то поставленный товар остается нашей собственностью вплоть до полной оплаты его цены.

8. Гарантия

Наша гарантия распространяется только на материал первого сорта, с приблизительным допуском в размере 5% (пяти процентов). Следовательно, явно исключается любая гарантия на дефекты материала второго и третьего сорта, а также товарных запасов, которые, так же как и случайные партии, продаются в состоянии, в котором они были "осмотрены и одобрены". Разница в тоне не принимается как дефект материала. Возможные претензии и споры должны сообщаться, под угрозой утраты права на них, заказным письмом, направленным исключительно на наш юридический адрес, перед укладкой материала и, в любом случае, до истечения предусмотренного законом срока. Укладка материала влечет за собой утрату права на требование компенсации по явным или скрытым дефектам, так как представляет собой отказ от гарантии, предусмотренной ст. 1490 ГК. В любом случае, наша гарантия предусматривает лишь только замену признанного дефектным материала с исключением всех остальных обязанностей. Мы не возлагаем на себя никакой ответственности относительно пригодности материала предусмотренному покупателем применению, даже в случае, если мы предоставили рекомендации или указания по установке и применению данного материала.

9. Торговые марки

Дистрибьютор обязан использовать названия, торговые марки, логотипы и домены, являющиеся исключительной собственностью компании Nuova Riwal Ceramiche S.r.l. и используемые ею, только в целях рекламы и продажи контрактных изделий. Как название Riwal Ceramiche, так и остальные названия, торговые марки, логотипы и домены, используемые компанией Nuova Riwal Ceramiche S.r.l., не должны присутствовать в фирменном названии, официальном наименовании или в предмете деятельности дистрибьютора, даже в словесных сочетаниях. Дистрибьютор обязуется не регистрировать и не использовать ни коим образом марки, названия и другие отличительные знаки, графические, фонетические или другим образом напоминающие марки и фирменные названия Nuova Riwal Ceramiche S.r.l., при чем он обязуется также не принимать никакое действие, которое может повредить компании Nuova Riwal Ceramiche S.r.l.

10. Компетентный суд

По любому спору, относящемуся к поставке, как продавец, так и покупатель признают, что компетентным судом является суд г. Модены, и что будет применяться итальянское законодательство.

11. Арбитраж

В случае международных поставок все споры и разногласия, связанные с контрактом, будут окончательно решаться в соответствии с Регламентом примирения и арбитража международной Торговой палаты одним или более судьями с соблюдением данного регламента. Оставляя неизменными приведенные выше общие условия, применяемым правом является лишь только итальянское право.

2СМ

Informazioni tecniche
Technical information
Informations techniques
Technische informationen
Información técnica
Техническая информация

LASTRE A SPESSORE MAGGIORATO PER PAVIMENTAZIONI ESTERNE.

2CM è la soluzione più evoluta per pavimentare aree esterne pedonali come giardini, balconi, camminamenti, pavimenti carrabili, ecc.

Le lastre 2CM sono ingelive, resistenti agli attacchi chimici, ai fattori atmosferici, agli agenti inquinanti; sono inassorbenti quindi di facile pulizia e manutenzione e grazie alla loro conformazione hanno una elevata resistenza alla flessione e agli urti e possono sopportare carichi statici elevati (dissuasori, panchine, fioriere, arredo urbano in genere).

Mediante l'utilizzo di supporti plastici (piedini) di varie misure ed altezze, le lastre vengono posate a secco su caldane grezze, guaine bituminose, pavimentazioni esistenti, creando delle intercapedini tecniche di altezza variabile che consentono sia il passaggio di reti impiantistiche che un regolare deflusso delle acque meteoriche.

Questo sistema consente di ottenere diversi vantaggi tecnici ed economici:

- Una riduzione considerevole dei tempi di posa.
- Un ottimo isolamento acustico e termico degli eventuali locali sottostanti grazie alla intercapedine d'aria che si forma tra la pavimentazione ed il sottofondo.
- Il riutilizzo totale del materiale in caso di interventi di ispezione o riparazione del sottofondo o degli impianti.

*Per maggiori informazioni su 2CM
contattare i nostri uffici commerciali.*

THICKER SLABS FOR OUTDOOR FLOORS.

2CM is an extremely cutting-edge solution for tiling outdoor pedestrian areas such as gardens, balconies, walkways, carriageable floors, etc.

2CM slabs are frostproof, and resistant to chemical attacks, atmospheric factors and polluting agents; they are non-absorbent and therefore easy to clean and maintain, and thanks to their conformation, they have high bending strength and shock resistance and can bear high static loads (bollards, benches, plant containers, and urban furniture in general).

With the use of plastic supports (feet) of various sizes and heights, the slabs are dry laid on rough concrete slabs, bituminous coatings or existing floors, creating technical cavities of variable height that allow both the passage of systems installations and the regular draining away of rainwater.

This system enables several technical and financial advantages to be obtained:

- A considerable reduction in laying times.
- Excellent acoustic and thermal insulation for any premises below, thanks to the air cavity that forms between floor and underlayer.
- The total re-use of the material in the case of inspection or repair interventions on the underlayer or the installations.

*For more information about 2CM,
please contact our sales offices.*

DALLES À ÉPAISSEUR MAJORÉE POUR CARRELAGE SOLS EXTÉRIEURS.

2CM est la solution la plus évoluée pour le revêtement d'espaces extérieurs tels que les passages sous jardins, balcons, les parcours dallés, carreaux passage, etc.

Les dalles 2CM sont ingélives, résistantes aux attaques chimiques, aux facteurs atmosphériques et aux agents polluants; elles sont étanches, donc faciles à nettoyer et à entretenir, et grâce à leur conformation elles sont hautement résistantes à la flexion et aux chocs et peuvent supporter des charges statiques élevées (bornes escamotables, bancs, jardinières, aménagement urbain en général).

En utilisant des supports plastiques (pieds) de dimensions et hauteurs différentes, les dalles sont posées à sec sur des supports bruts, des gaines bitumineuses, des dallages existant déjà, en créant ainsi des interstices techniques de hauteur variable qui permettent tout aussi bien de faire passer des réseaux d'équipement qu'un écoulement régulier des eaux de pluie.

Ce système permet d'obtenir plusieurs avantages techniques et économiques :

- Une réduction considérable des temps de pose.
- Une excellente isolation acoustique et thermique des pièces situées éventuellement au-dessous, et ce grâce à l'interstice d'air qui se forme entre le sol et la sous-couche.
- La réutilisation totale du matériau en cas d'inspection ou de réparation de la sous-couche ou des équipements.

*Pour de plus amples informations concernant le 2CM
prière de contacter nos services commerciaux.*

PLATTEN MIT HÖHERER STÄRKE FÜR BODENVERKLEIDUNGEN IN AUSSENRAÜMEN.

2CM ist die fortschrittlichste Lösung für die Verlegung von Fußböden in externen Fußgängerbereichen wie Garten, Balkon, Gehwege, Befahrbarbelag, usw.

Die Platten 2CM sind frostfest und gegen Chemikalien, Witterungseinflüsse und Schmutzmittel beständig. Sie sind nicht aufnahmefähig und daher leicht zu reinigen und instand zu halten, besitzen dank ihrer Form eine gehobene Biege- und Stoßfestigkeit und können hohe statische Lasten tragen (Absperpoller, Bänke, Blumenkästen und Stadtmobiliar im Allgemeinen).

Die Platten werden unter Verwendung von Kunststoffträgern (Füßchen) in verschiedenen Größen und Höhen trocken auf groben Estrichen, Bitumenmäntel oder alten Bodenbelägen verlegt und bilden technische Zwischenschichten in veränderlichen Höhen, die sowohl die Durchführung von Anlagennetzen als auch das ordnungsgemäße Abfließen von Regenwasser ermöglichen.

Dieses System bietet verschiedene technische und wirtschaftliche Vorteile:

- Beachtlich kürzere Verlegungszeiten.
- Eine ausgezeichnete Schall- und Wärmeisolierung der eventuell darunter befindlichen Räume, dank der Luftzwischenheit, die sich zwischen dem Bodenbelag und dem Untergrund bildet.
- Eine volle Wiederverwendbarkeit des Materials im Falle von Inspektionen oder Reparaturen des Untergrundes oder der Anlagen.

*Unsere Vertriebsabteilung liefert gerne
nähere Infos über 2CM.*

2CM

posa sopraelevata

raised laying - pose surelevée - erhöhtes verlegen



2CM garantisce estetica e performance di primo livello anche per la creazione di pavimenti sopraelevati. In esterno tale soluzione permette di creare, tra il piano di sottofondo e quello di calpestio costituito dalle lastre ceramiche, uno spazio SEMPRE ISPEZIONABILE per l'allocatione di impianti e tubazioni di ogni genere.

2CM guarantees top-class beauty and performance also when creating outdoor raised floors. With this solution, a space can be made, between the underlayer and the floor for foot traffic comprising ceramic slabs, which CAN ALWAYS BE INSPECTED for the fitting of all kinds of installations and piping.

2CM garantit esthétique et performances exceptionnelles y compris pour la réalisation de dallages surélevés. A l'extérieur, cette solution permet de créer, entre la sous-couche et le plan de passage formé par les dalles céramiques, un espace qui RESTE CONTROLABLE pour la mise en place d'installations et de conduites en tout genre.

2CM garantiert eine schöne Optik und Performance erster Klasse auch für die Bildung erhöhter Fußböden. Im Außenbereich kann durch diese Lösung zwischen der Unterputz- und Trittlfläche, welche aus Keramikplatten besteht, ein Raum geschaffen werden, in dem Anlagen und Rohrleitungen jeglicher Art untergebracht werden können UND DER FÜR INSPEKTIONEN STETS ZUGÄNGLICH ist.

technical section



Installazione in prossimità di muretti, angoli e spigoli

verlegung in der nähe von wänden, aussenecken und innenecken

pose en oeuvre a proximité des murs, d'angles rentrants ou sortants

installation close to walls, corners or edges

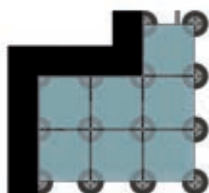

É necessario allontanare i supporti dal muro tagliando due o tutti e quattro i distanziatori.

The supports must be furthered from walls, corners and edges by cutting two or even all the spacers of their top.

A proximité des murs, d'angles rentrants et d'angles sortants, il faut éloigner les supports en coupant deux ou quatre pièces intercalaires.

In der Nähe von Wänden, Außenecken und Innenecken müssen die Stelzlager mit Abstand von der Wand platziert werden oder 2 bzw. 4 Abstandhalter eingeschnitten werden.

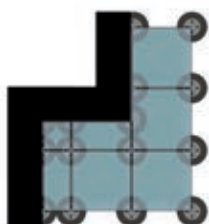

Talvolta è necessario tagliare anche la base dei supporti in caso di interferenza con la base dei supporti adiacenti.

The base of the supports must also be cut in case it obstructs the base of adjacent supports.

En cas d'interférence avec la base des supports adjacents il sera nécessaire de couper aussi la base des supports.

Unter Umständen ist es auch notwendig die Basis der Stelzlager anzupassen, wenn man diese sehr eng beieinander positionieren muß.

posa a secco

dry laying - pose a sec - trockenverlegen

2CM

Le lastre 2CM sono posabili a secco dando vita a PERCORSI e CAMMINAMENTI PEDONALI SU SOTTOFONDI IN ERBA, GHIAIA E SABBIA. Il sistema di posa a secco è immediatamente calpestabile, pratico ed ecologico, in quanto si evita la creazione del tradizionale massetto armato e si esclude totalmente l'impiego di collanti. Il nuovo sistema ceramico di Saimè è applicabile in tutti gli ambienti esterni come spiagge, cortili, giardini e terrazzi, grazie alle prestazioni tecniche e alla valenza estetica del gres porcellanato.

2CM slabs can be dry-laid, in order to make PEDESTRIAN PATHS AND WALKWAYS ON GRASS, GRAVEL AND SAND UNDERLAYERS. The dry-laying system can be walked over immediately and is practical and eco-friendly, since it avoids creating the traditional reinforced concrete floor and completely avoids the use of adhesives. This new ceramic system from Saimè can be applied in all outdoor surroundings such as shores, courtyards, gardens and terraces, exploiting the technical features and high-quality appearance of porcelain stoneware.

Les dalles 2CM se posent à sec, pour créer des PARCOURS ET PASSAGES PIETONNIERS SUR SOUS-COUCHE D'HERBE, GRAVIER ET SABLE. Le système de pose à sec permet une fréquentation immédiate, il est pratique et écologique car il évite la réalisation de la traditionnelle chape armée ainsi que toute utilisation de colle. Le nouveau système céramique de Saimè trouve son application en tout lieu extérieur tels que plages, cours, jardins et terrasses grâce à ses propriétés techniques et à l'intérêt esthétique du grès cérame.

Die Platten 2CM sind trocken verlegbar und bilden STRECKEN SOWIE FUSSGÄNGERWEGE AUF UNTERPUTZ AUS GRAS, KIES UND SAND. Das Trockenverlegesystem ist sofort betretbar, praktisch und umweltfreundlich, da die Erzeugung des traditionellen armierten Unterbetonblocks vermieden wird und man keinerlei Kleber einzusetzen braucht. Dank der technischen Leistungen und der Optik des Steinzeugs ist das neue Keramiksystem von Saimè in allen Außenräumen wie Stränden, Höfen, Gärten und Terrassen anwendbar.



Ghiaietto - Gravel - Gravier - Kies



Sabbia - Sand - Sable - Sand

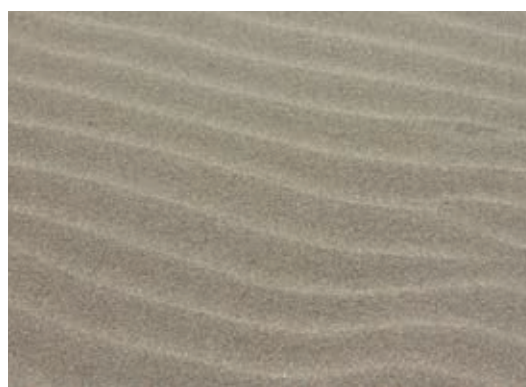

Erba - Gras - Herbe - Grass



technical section

THINKGREEN

Saime Ceramiche pone al centro dell'azione una particolare sensibilità all'ecosostenibilità dei propri processi industriali.

Il costante investimento di capitali e professionalità pone l'azienda all'avanguardia nello sviluppo di sistemi produttivi a massima efficienza e minimo impatto, in grado di garantire un pieno rispetto dell'ambiente e l'eccellenza di una gamma di prodotti totalmente ecocompatibili.

Saime Ceramiche places great emphasis on having a special sensitivity to eco-sustainability in its industrial processes.

Constant investments of capital and professional skills places the company at the leading edge in developing maximum efficiency, minimum impact production systems, that will guarantee full respect for the environment, as well as excellence in the totally eco-compatible product range.

Saime Ceramiche accorde un intérêt tout particulier à l'éco-durabilité de ses processus industriels.

Par ses investissements constants en matière de capitaux et de professionnalisme, l'entreprise est à l'avant-garde dans le développement de systèmes de production qui allient efficacité maximale et impact minimal, assurant un respect absolu de l'environnement et l'excellence d'une gamme de produits totalement éco-compatibles.

Saime Ceramiche legt großen Wert auf die ökologische Nachhaltigkeit seiner Industrieprozesse.

Durch die konstanten Investitionen in Kapital und Fachwissen steht das Unternehmen an vorderster Stelle bei der Entwicklung von Produktionssystemen mit maximaler Effizienz und minimaler Umweltbelastung; dadurch wird der Schutz der Umwelt und die Qualität von vollumfänglich nachhaltigen Produkten garantiert.

Saime Ceramiche pone en el centro de la acción una particular sensibilidad por la ecosostenibilidad de sus procesos industriales.

La constante inversión de capitales y en profesionalidad coloca a la empresa en la vanguardia del desarrollo de sistemas productivos con máxima eficiencia y mínimo impacto, capaces de garantizar un pleno respeto del medio ambiente y la excelencia de una gama de productos totalmente ecocompatibles.

В работе Saime Ceramiche особое внимание уделяется экологической рациональности собственных промышленных процессов.

Благодаря постоянным инвестициям капиталов и профессиональных навыков компания занимает передовые позиции в развитии максимально эффективных, минимально загрязняющих производственных систем, гарантирующих полную охрану природы и высокие характеристики совершенно экологичной продукции.



Saime Ceramiche definisce i propri sistemi produttivi nel pieno rispetto dei rigidi requisiti IPPC (Integrated Pollution Prevention and Control) in materia di riduzione delle emissioni inquinanti, efficienza energetica e ottimizzazione produttiva. Tutti i prodotti Saime Ceramiche sono realizzati attraverso processi e tecnologie che ne garantiscono sempre massima qualità e sostenibilità ambientale.

Saime Ceramiche defines its production systems in full compliance with the stringent IPPC (Integrated Pollution Prevention and Control) requirements with regard to reducing polluting emissions, energy efficiency and optimizing production. All Saime Ceramiche products are created with processes and technologies that always guarantee maximum quality and environmental sustainability.

Les systèmes de production Saime Ceramiche respectent pleinement les strictes exigences de la directive IPPC (Integrated Pollution Prevention and Control, prévention et réduction intégrées de la pollution) en matière d'émissions polluantes, d'efficacité énergétique et d'optimisation de la production. Tous les produits Saime Ceramiche sont réalisés au moyen de processus et de technologies assurant toujours une qualité maximale et la durabilité environnementale.

Die Produktionssysteme von Saime Ceramiche werden so projektiert, dass sie den strengen Anforderungen der IPPC (Integrated Pollution Prevention and Control), was die Reduktion der Schadstoffe, die Energieeffizienz und die Produktionsoptimierung betrifft, voll entsprechen. Alle Produkte von Saime Ceramiche werden mit Verfahren und Technologien realisiert, die stets höchste Qualität und Umweltverträglichkeit garantieren.

Saime Ceramiche define sus sistemas productivos respetando los rígidos requisitos IPPC (Integrated Pollution Prevention and Control) en materia de reducción de emisiones contaminantes, eficiencia energética y optimización productiva. Todos los productos Saime Ceramiche están realizados a través de procesos y tecnologías que garantizan siempre la máxima calidad y sostenibilidad medioambiental de los mismos.

Saime Ceramiche разработывает свои производственные системы с полным соблюдением жестких требований IPPC (Integrated Pollution Prevention and Control, комплексное предотвращение и контроль загрязнений) в плане снижения загрязняющих выбросов, энергоэффективности и оптимизации производства. Вся продукция Saime Ceramiche выпускается с применением процессов и технологий, обеспечивающих наивысшее качество и экологическую рациональность.





MASSIMA SICUREZZA

Il ciclo di produzione è severamente controllato attraverso verifiche periodiche. Macchine, impianti e lavoratori sono dotati dei più moderni sistemi di sicurezza.

MAXIMUM SAFETY

The production cycle is strictly controlled by means of periodic checks. Machines, equipment and workers are equipped with very up-to-date safety systems.

SÉCURITÉ MAXIMALE

Grâce à des contrôles réguliers, un suivi scrupuleux du cycle de production est assuré. Machines, installations et travailleurs sont équipés des dispositifs de sécurité les plus modernes.

MAXIMALE SICHERHEIT

Der Produktionszyklus wird anhand von periodisch durchgeführten Überprüfungen strengstens kontrolliert. Maschinen, Anlagen und Mitarbeiter sind mit modernsten Sicherheitssystemen ausgestattet.

MÁXIMA SEGURIDAD

El ciclo de producción está severamente controlado a través de verificaciones periódicas. Las máquinas, las instalaciones y los trabajadores están equipados de los sistemas de seguridad más modernos.

НАИВЫСШАЯ БЕЗОПАСНОСТЬ

Производственный цикл постоянно проверяется и подвергается периодическому контролю. Самые современные системы безопасности применяются для охраны оборудования, систем и работников.



RICICLO TOTALE

Tutti gli scarti di processo, liquidi, solidi cotti e crudi, sono integralmente recuperati all'interno del ciclo produttivo.

TOTAL RECYCLING

All process waste, liquids, and fired and raw solids are recovered entirely within the production cycle.

RECYCLAGE TOTAL

Tous les rebuts de production, liquides, solides cuits et crus, sont entièrement réintroduits dans le cycle de production.

TOTALRECYCLING

Alle Prozessabfälle, Flüssigkeiten, gebranntes und rohes Festmaterial werden innerhalb des Produktionszyklus recycelt.

RECICLAJE TOTAL

Todos los desechos del proceso, líquidos, sólidos cocidos y crudos, se pueden recuperar integralmente en el ciclo de producción.

ПОЛНАЯ ПЕРЕРАБОТКА

Все жидкие и твердые, сырые или обожженные отходы полностью перерабатываются в рамках производственного процесса.



ZERO EMISSIONI

Le emissioni gassose sono integralmente depurate attraverso le più avanzate tecnologie di filtraggio.

ZERO EMISSIONS

Gaseous emissions are completely purified using cutting-edge filtering technologies.

ZÉRO ÉMISSION

Les émissions gazeuses sont entièrement épurées à l'aide des technologies de filtration les plus avancées.

NULLEMISSIONEN

Die Abgasemissionen werden über die fortschrittlichsten Filtertechnologien gereinigt.

CERO EMISIONES

Las emisiones gaseosas se depuran completamente a través de las tecnologías de filtración más modernas.

НУЛЕВЫЕ ВЫБРОСЫ

Газовые выбросы полностью очищаются с применением самых передовых технологий фильтрации.



EFFICIENZA ENERGETICA

Produzione autonoma di energia attraverso un innovativo impianto di cogenerazione che consente un'elevata efficienza energetica.

ENERGY EFFICIENCY

Independent energy production by means of an innovative cogeneration plant that allows high energy efficiency.

EFFICACITÉ ÉNERGÉTIQUE

Une installation de cogénération innovante à haute efficacité énergétique assure l'autonomie en matière de production d'énergie.

ENERGIEEFFIZIENZ

Autonome Energieproduktion anhand einer innovativen Wärme-Kraft-Kopplungsanlage, die eine hohe Energieeffizienz zusichert.

EFICIENCIA ENERGÉTICA

Producción autónoma de energía a través de una innovadora planta de cogeneración que permite obtener una elevada eficiencia energética.

ЭНЕРГОЭФФЕКТИВНОСТЬ

Автономное производство электроэнергии осуществляется при помощи инновационной когенерационной установки, обеспечивающей высокую энергетическую эффективность.



NO SOSTANZE TOSSICHE

Totale assenza di sostanze tossiche e/o nocive all'interno dei processi di lavorazione e in ogni fase del ciclo di produzione.

NO TOXIC SUBSTANCES

Complete absence of toxic and/or harmful substances in the working processes and in each phase of the production cycle.

PAS DE SUBSTANCES TOXIQUES

Absence totale de substances toxiques et/ou nocives dans les processus de traitement et dans chaque phase du cycle de production.

KEINE GIFTIGEN STOFFE

Absolut frei von giftigen und/oder schädlichen Stoffen innerhalb der Bearbeitungsprozesse und in jeder Phase des Produktionszyklus.

NINGUNA SUSTANCIA TÓXICA

Total ausencia de sustancias tóxicas y/o nocivas en los procesos de elaboración y en las fases del ciclo de producción.

ОТКАЗ ОТ ТОКСИЧНЫХ ВЕЩЕСТВ

Токсичные и/или вредные вещества полностью отсутствуют в процессах обработки и на любом этапе производственного цикла.

LEED



La certificazione LEED (Leadership in Energy and Environmental Design) è un sistema di certificazione sostenibilità aziendale ed energetica degli edifici applicato in oltre 140 paesi nel mondo. Elaborata nel 1993 dalla U.S. Green Building Council (USGBC) ha come scopo base la promozione e lo sviluppo di un approccio globale alla sostenibilità ambientale, sociale ed economica degli edifici, dalla fase di progettazione fino alla gestione quotidiana. Il metodo di certificazione prevede l'attribuzione di un punteggio all'edificio riconosciuto sulla base della verificata conformità dello stesso a diversi prerequisiti e crediti Leed.

Il gres porcellanato di Saime Ceramiche è un materiale Leed compliant, ovvero soddisfa i requisiti definiti dalla USGBC per i materiali e le risorse in termini di percentuale di materiale riciclato, effetti isolanti, basse emissioni inquinanti e proprietà innovative e di design. Ciò significa che l'impiego dei materiali Saime Ceramiche per pavimenti o rivestimenti consente l'assegnazione di un punteggio che concorrerà all'attribuzione della certificazione LEED.

LEED (Leadership in Energy and Environmental Design) certification is a system for certifying company and energy sustainability of buildings, and is applied in over 140 countries in the world. It was devised in 1993 by the U.S. Green Building Council (USGBC) and its basic aim is to promote and develop a global approach to environmental, social and economic sustainability of buildings, from the design phase right down to their daily management. This method of certification provides for assigning points to the building, worked out on the basis of its verified compliance with various Leed requirements and credits

Saime Ceramiche porcelain stoneware are Leed-compliant materials: that is, they meet the requirements defined by the USGBC for materials and resources in terms of percentage of recycled material, insulating effects, low polluting emissions and innovative and design properties. This means that the use of Saime Ceramiche materials for floors or wall tiling allows points to be assigned, that will contribute to giving LEED certification.

La certification LEED (Leadership in Energy and Environmental Design) est un système de certification de la durabilité des bâtiments reconnu dans plus de 140 pays, appliqué à l'entreprise et à l'énergie. Élaborée en 1993 par le U.S. Green Building Council (USGBC), son but fondamental est de promouvoir et développer une approche globale de la durabilité environnementale, sociale et économique des bâtiments, de la phase de conception à la gestion quotidienne. La méthode de certification prévoit l'attribution de points au bâtiment après vérification de sa conformité par rapport à différents critères et crédits LEED.

Le grès cérame de Saime Ceramiche est un matériau conforme au système LEED, c'est-à-dire qu'il respecte pleinement les critères définis par le USGBC pour les matériaux et les ressources, relatifs au pourcentage de matériaux recyclés, aux effets isolants, aux basses émissions polluantes, aux propriétés innovantes et au design. L'utilisation sur sols ou revêtements des matériaux Saime Ceramiche donne ainsi droit à l'attribution de points qui contribueront à l'obtention de la certification LEED.

Die Zertifizierung LEED (Leadership in Energy and Environmental Design) ist ein System für die Unternehmens- und Energienachhaltigkeit von Gebäuden, das in mehr als 140 Ländern der Welt angewandt wird. 1993 vom U.S. Green Building Council (USGBC) erarbeitet, hat sie als Hauptziel die Förderung und Entwicklung eines globalen Ansatzes mit Bezug auf die umweltbezogene, soziale und wirtschaftliche Nachhaltigkeit der Gebäude, von der Projektphase bis zur täglichen Verwaltung. Die Zertifikationsmethodik sieht eine Punkteverteilung an diejenigen Gebäude vor, die aufgrund von deren überprüfter Konformität den verschiedenen Anforderungen und Leed-Krediten gegenüber anerkannt wurden.

Das Steinzeug von Saime Ceramiche ist ein Leed-konformes Material, das heißt, es erfüllt die von der USGBC für die Materialien und Ressourcen festgelegten Anforderungen im Hinblick auf die Prozentzahl der recycelten Materialien, die Isolierung, die niedrige Schadstoffemission und die innovativen und designbezogenen Eigenschaften. Daraus folgt, dass die Verwendung von Saime Ceramiche-Produkten für Fußböden oder Wandverkleidungen die Zuordnung einer Punktzahl erlaubt, die zur Vergabe der LEED-Zertifizierung beiträgt.

La certificación LEED (Leadership in Energy and Environmental Design) es un sistema de certificación de la sostenibilidad empresarial y energética de los edificios aplicado en más de 140 países del mundo. Creado en 1993 por el U.S. Green Building Council (USGBC), tiene como objetivo fundamental promover y desarrollar un enfoque global de la sostenibilidad medioambiental, social y económica de los edificios, desde la fase de diseño hasta la gestión diaria. El método de certificación prevé la atribución de puntos al edificio reconocido sobre la base de la verificación de conformidad del mismo a diferentes prerrequisitos y créditos Leed.

El grés porcelánico de Saime Ceramiche es un material conforme a Leed, es decir, satisface los requisitos definidos por el USGBC para los materiales y los recursos, en términos de porcentaje de material reciclado, efectos aislantes, bajas emisiones contaminantes y propiedades innovadoras y de diseño. Esto significa que el empleo de los materiales Saime Ceramiche para los pavimentos o revestimientos permite asignar una puntuación útil para la atribución de la certificación LEED.

Сертификат LEED (Leadership in Energy and Environmental Design) - это система сертификации корпоративной и энергетической рациональности зданий, которая используется в более, чем 140 странах мира. Она была разработана в 1993 году организацией U.S. Green Building Council (USGBC) и направлена на поощрение и развитие общего подхода к экологической, социальной и экономической рациональности зданий с момента их проектирования до ежедневной эксплуатации. Метод сертификации предусматривает присвоение зданию баллов, основываясь на подтвержденном соответствии объекта разным установленным требованиям и кредитам Leed.

Керамогранит компании Saime Ceramiche является материалом "Leed compliant", то есть, удовлетворяющим требованиям USGBC к материалам и ресурсам в плане процентного содержания переработанного материала, изоляционного эффекта, низкого выделения загрязняющих веществ, инновационных качеств и дизайна. Это значит, что использование материалов Saime Ceramiche для настила полов или облицовки стен позволяет получать баллы, способствующие выдаче сертификата LEED.

SCHEDA PUNTEGGIO

PRODOTTI SAIME CERAMICHE:

CONTRIBUTI ALL'OTTENIMENTO DEL PUNTEGGIO:

Contenuto di Materiale Riciclato (Credito MR 4.1): 2 PUNTI LEED

Oltre il 25% del materiale che costituisce i nostri prodotti contiene materiali crudi e cotti di riciclo (materiale pre-consumo)

Ottimizzazione della Performance Energetica (Credito EA 1): I prodotti Saime Ceramiche concorrono ad accumulare crediti da 1 a 10 PUNTI LEED

Le piastrelle ceramiche essendo materiali a bassa conducibilità termica e soggette a bassissimi sbalzi termici, sono dotate di potere isolante e contribuiscono al risparmio energetico. I nostri prodotti sono particolarmente indicati per rivestimenti di facciate, ventilate e non, e per sistemi di riscaldamento a pavimento

Contenuto di Composti organici volatili VOC (Credito EQ 4.3): 1 PUNTO LEED

Le piastrelle ceramiche, per la loro conformazione, sono a bassissima emissione di sostanze organiche volatili e pertanto rispettano la categoria di credito EQ 4.3 per la qualità ambientale interna.

POINTS SHEET

SAIME CERAMICHE PRODUCTS:

CONTRIBUTIONS TO OBTAINING POINTS:

Content of Recycled Material (Credit MR 4.1): 2 LEED POINTS

Over 25% of the material comprising our products contains recycled raw and fired materials (pre-consumer waste).

Optimization of Energy Performance (Credit EA 1): Saime Ceramiche products contribute to accumulating credits from 1 to 10 LEED POINTS

Ceramic tiles, being low thermal conductivity materials and subject to very low thermal excursions, have insulating properties and contribute to saving energy. Our products are particularly recommended for tiling facades, both ventilated and otherwise, and for underfloor heating systems.

VOC - Volatile organic compounds - content (Credit EQ 4.3): 1 LEED POINT

Ceramic tiles, because of their conformation, have very low emissions of volatile organic substances and therefore comply with credit category EQ 4.3 for indoor environmental quality.

FICHE DE POINTS

PRODUITS SAIME CERAMICHE:

CONTRIBUTIONS À L'OBTENTION DE POINTS:

Contenu recyclé (Crédit MR 4.1): 2 POINTS LEED

Plus de 25 % des matériaux entrant dans la composition de nos produits contient des matériaux recyclés crus et cuits (matériaux pré-consommation).

Optimisation de la performance énergétique (Crédit EA 1): les produits Saime Ceramiche peuvent cumuler de 1 à 10 POINTS LEED

Les carreaux en céramique, un matériau à basse conductibilité thermique sujet à de très faibles écarts thermiques, présentent des propriétés isolantes et contribuent à économiser les ressources énergétiques. Nos produits sont particulièrement indiqués en revêtement de paroi ventilée ou non, ainsi que pour les systèmes de chauffage au sol.

Contenu en COV (composés organique volatils) (Crédit EQ 4.3): 1 POINT LEED

De par leur conformation, les carreaux en céramique présentent de très faibles émissions de composés organiques volatils. Ils respectent à ce titre les exigences de la catégorie EQ 4.3 pour la qualité des environnements intérieurs.

FICHA DE PUNTUACIÓN

PRODUCTOS SAIME CERAMICHE:

CONTRIBUCIONES PARA OBTENER LA PUNTUACIÓN:

Contenido de Material Reciclado (Crédito MR 4.1): 2 PUNTOS LEED

Más del 25% del material que constituye nuestros productos contiene materiales crudos y cocidos provenientes del reciclaje (material pre-consumo).

Optimización del Rendimiento Energético (Crédito ES 1) Los productos Saime Ceramiche contribuyen a acumular créditos de 1 a 10 PUNTOS LEED

Las baldosas cerámicas, siendo materiales de baja conductibilidad térmica y estando sujetas a muy bajos cambios repentinos de temperatura, tienen un poder aislante y contribuyen al ahorro energético. Nuestros productos están particularmente indicados para revestimientos de fachadas, ventiladas y no ventiladas, y para sistemas de calefacción radiante a través del pavimento.

Contenido de compuestos orgánicos volátiles VOC (Crédito EQ 4.3): 1 PUNTO LEED

Las baldosas cerámicas, por su conformación, tienen una emisión muy baja de sustancias orgánicas volátiles y, por lo tanto, respetan la categoría de crédito EQ 4.3 para la calidad medioambiental interna.

PUNKTEVERTEILUNG

PRODUKTE SAIME CERAMICHE:

BEITRAG ZUR VERGABE VON PUNKTEN:

Gehalt von recyceltem Material (Kredit MR 4.1): 2 LEED-PUNKTE

Mehr als 25% des Materials, aus denen unsere Produkte bestehen, enthält gebranntes oder rohes Recyclingmaterial (Pre-consumer Material)

Optimierung der Energieleistung (Kredit EA 1): Die Produkte Saime Ceramiche tragen zur Sammlung von Krediten von 1 bis 10 LEED-PUNKTEN bei

Als Materialien mit geringer Wärmeleitfähigkeit und großer Temperaturwechselbeständigkeit sind Keramikfliesen mit Wärmedämmvermögen ausgestattet und tragen zur Energieersparnis bei. Unsere Produkte sind besonders geeignet für Fassadenverkleidungen mit oder ohne Hinterlüftung und für Fußboden-Heizsysteme

Gehalt von Flüchtigen Organischen Verbindungen VOC (Kredit EQ 4.3): 1 LEED-PUNKT

Durch ihre Zusammensetzung haben Keramikfliesen sehr geringe Emissionen von flüchtigen organischen Verbindungen und entsprechen daher der Kreditkategorie EQ 4.3 für die interne Umweltqualität.

ПРАВИЛА ПОЛУЧЕНИЯ БАЛЛОВ

ПРОДУКЦИЯ SAIME CERAMICHE:

ВКЛАД ДЛЯ ПОЛУЧЕНИЯ БАЛЛОВ:

Содержание повторно использованного материала (Кредит MR 4.1): 2 БАЛЛА LEED

Более 25% материала, из которого состоит наша продукция, содержит сырые и обожженные переработанные материалы (пред-потребительский материал)

Оптимизация энергетических характеристик (Кредит EA 1): продукция Saime Ceramiche позволяет получать кредиты в размере от 1 до 10 БАЛЛОВ LEED

Керамическая плитка является материалом с низкой теплопроводностью, подвергается очень низким тепловым перепадам, обладает изоляционной способностью и позволяет экономить энергию. Наша продукция особенно рекомендована для облицовки вентилируемых или обычных фасадов и для напольных отопительных систем.

Содержание летучих органических компонентов VOC (кредит EQ 4.3): 1 БАЛЛ LEED

Ввиду своей конструкции керамическая плитка выделяет очень низкое количество летучих органических компонентов, поэтому она входит в категорию кредита EQ 4.3 за качество внутренней среды.

LA COSTANTE RICERCA TECNOLOGICA SI RISERVA DI APPORTARE SOLUZIONI ESTETICHE MIGLIORATIVE RISPETTO A QUANTO PROPOSTO NEL CATALOGO.
IN VIEW OF CONSTANT TECHNOLOGICAL RESEARCH, WE RESERVE THE RIGHT TO PROVIDE IMPROVED AESTHETIC SOLUTIONS COMPARED TO THOSE
PROPOSED IN THE CATALOGUE.

LA RECHERCHE TECHNOLOGIQUE CONSTANCE SE RESERVE D'APPORTER DES AMELIORATIONS ESTHETIQUES PAR RAPPORT AUX SOLUTIONS PROPOSEES
DANS LE CATALOGUE.

AUF GRUND DER STÄNDIGEN TECHNOLOGISCHEN FORSCHUNG BEHALTEN WIR UNS VOR, ÄSTHETISCHE VERBESSERUNGEN AN DEN IM KATALOG
ANGEBOTENEN LÖSUNGEN VORZUNEHMEN.

В СВЯЗИ С ПОСТОЯННЫМИ ТЕХНОЛОГИЧЕСКИМИ ИССЛЕДОВАНИЯМИ ФИРМА ОСТАВЛЯЕТ ЗА СОБОЙ ПРАВО НА УСОВЕРШЕНСТВОВАНИЕ ЭСТЕТИЧЕСКИХ
РЕШЕНИЙ, ПРЕДЛАГАЕМЫХ В КАТАЛОГЕ.

I COLORI RIPRODOTTI NEL PRESENTE CATALOGO SONO SOGGETTI ALLE TOLLERANZE PREVISTE DALLA STAMPA.

COLOURS SHOWN ON THIS CATALOGUE ARE SUBJECT TO TOLERANCES DUE TO PRINTING.

LES COLORIS REPRODUITS DANS CE CATALOGUE SONT SUJETS AUX TOLÉRANCES PRÉVUES POUR L'IMPRESSION.

DIE IN DIESEM KATALOG WIEDERGEgebenEN FARBEN SIND DEN FÜR DEN DRUCK VORGEGEHENEN SCHWANKUNGEN UNTERWORFEN.

LOS COLORES REPRODUCIDOS EN ESTE CATÁLOGO SON SUJETOS A LAS TOLERANCIAS DE LA IMPRESIÓN.

Цвета, воспроизведенные в настоящем каталоге, имеют предусмотренные для печати допуски.



Ceramics of Italy

Listino prezzi

PRICELIST - TARIF - PREISLISTE - ПРАЙС-ЛИСТ

Categoria Prezzo Price level Categorie Prix Preisklasse Ценовая категория	1° scelta 1° class 1° choix 1. Sorte 1-й сорт
1	0,30
2	0,60
3	0,90
4	1,20
5	1,40
6	1,70
7	2,00
8	2,30
9	2,60
10	2,90
11	3,10
12	3,40
13	3,70
14	4,00
15	4,30
16	4,60
17	4,90
18	5,20
19	5,40
20	5,70
21	6,00
22	6,20
23	6,50
24	6,80
25	7,10
26	7,40
27	7,50
28	7,90
29	8,30
30	8,60
31	8,80
32	9,20
33	9,40
34	9,70
35	10,00
36	10,20
37	10,50
38	10,80
39	11,20
40	11,40
41	12,00
42	12,50
43	13,10
44	13,60
45	14,20
46	14,80
47	15,40
48	15,90
49	16,60
50	17,10
51	17,60
52	18,20
53	18,80
54	19,30
55	19,90
56	20,40
57	21,10
58	21,60
59	22,20
60	22,80
61	23,30

Categoria Prezzo Price level Categorie Prix Preisklasse Ценовая категория	1° scelta 1° class 1° choix 1. Sorte 1-й сорт
62	23,90
63	24,50
64	25,10
65	25,70
66	26,20
67	26,70
68	27,30
69	27,90
70	28,50
71	29,00
72	29,70
73	30,20
74	30,70
75	31,40
76	31,90
77	32,40
78	33,00
79	33,70
80	34,20
81	35,30
82	36,40
83	37,60
84	38,70
85	39,90
86	41,00
87	42,20
88	43,30
89	44,40
90	45,50
91	46,80
92	47,80
93	49,00
94	50,00
95	51,30
96	52,40
97	53,50
98	54,60
99	55,90
100	56,90
101	58,10
102	59,30
103	60,40
104	61,40
105	62,60
106	63,90
107	64,90
108	66,10
109	67,10
110	68,40
111	70,90
112	74,10
113	76,90
114	79,70
115	82,70
116	85,50
117	88,30
118	91,10
119	94,10
120	96,70
121	99,70
122	102,60

Categoria Prezzo Price level Categorie Prix Preisklasse Ценовая категория	1° scelta 1° class 1° choix 1. Sorte 1-й сорт
123	105,30
124	108,20
125	111,20
126	113,90
127	119,60
128	125,30
129	131,00
130	136,70
131	142,40
132	148,10
133	153,60
134	159,40
135	165,20
136	170,90
137	176,50
138	182,20
139	188,30
140	193,40
141	199,60
142	205,00
143	211,00
144	217,00
145	222,00
146	228,00
147	239,00
148	251,00
149	262,00
150	274,00
151	285,00
152	297,00
153	307,00
154	319,00
155	330,00
156	342,00
157	365,00
158	387,00
159	410,00
160	433,00
161	455,00
162	478,00
163	500,00
164	524,00
165	546,00
166	569,00
167	614,00
168	661,00
169	706,00
170	752,00
171	797,00
172	843,00
173	888,00
174	934,00
175	980,00
176	1025,00
177	1070,00
178	1118,00
179	1161,00
185	1367,00
300	1723,00
350	2178,00

00 ●

FASCIA DI PREZZO ARTICOLI VENDUTI A MQ.
PRICE RANGE FOR ITEMS SOLD PER SQUARE METRE
FOURCHETTE DE PRIX DES ARTICLES VENDUS AU M²
PREISKLASSE PRO QM VERKAUFTE ARTIKEL
ЦЕНОВОЙ СЕГМЕНТ ИЗДЕЛИЙ, ПРОДАВАЕМЫХ ЗА КВ.М

00 ▲

FASCIA DI PREZZO ARTICOLI VENDUTI A PEZZO
PRICE RANGE FOR ITEMS SOLD PER UNIT
FOURCHETTE DE PRIX DES ARTICLES VENDUS A LA PIECE
PREISKLASSE PRO STÜCK VERKAUFTE ARTIKEL
ЦЕНОВОЙ СЕГМЕНТ ИЗДЕЛИЙ, ПРОДАВАЕМЫХ ПОШТУЧНО

Simbologia

SYMBOLICS - SYMBOLES - SYMBOLE - СИМВОЛЫ

GM

GRES PORCELLANATO CON COLORAZIONE IN MASSA

PORCELAINED STONEWARE WITH MASS COLOURING
GRES CERAME AVEC PATE COLOREE
DURCHGEFÄRBTES FEINSTEINZEUG
ФАРФОРОВЫЙ КЕРАМОГРАНИТ, ОКРАШЕННЫЙ ПО

GS

GRES PORCELLANATO SMALTATO

GLAZED GRES PORCELAIN
GRES CERAME EMAILLE
GLASIERTES FEINSTEINZEUG
ГЛАЗУРОВАННЫЙ ФАРФОРОВЫЙ КЕРАМОГРАНИТ



IN CASO DI POSA A CORRERE CON FORMATI RETTANGOLARI SI CONSIGLIA UNA POSA SFALSATA A 1/4.

WITH RUNNING INSTALLATIONS USING RECTANGULAR FORMATS WE RECOMMEND STAGGERING BY 1 /4 OF TILE LENGTH.
EN CAS DE POSE DROITE AVEC DES FORMATS RECTANGULAIRES, UNE POSE DECALEE A 1/4 EST RECOMMANDEE.
BEI FORTLAUFENDER VERLEGUNG MIT RECHTECKIGEN FORMATEN EMPFIEHLT SICH EINE VERLEGUNG VERSETZT IM 1/4-VERBAND.
В СЛУЧАЕ УКЛАДКИ ПРЯМОУГОЛЬНЫХ ФОРМАТОВ В РАЗГОН РЕКОМЕНДУЕМ СМЕЩАТЬ ИХ НА.



FUGA MINIMA CONSIGLIATA

ADVISED MINIMUM JOINT
JOINT MINIMUM CONSEILLÉ
EMPFEHLTE FUGE
МИНИМАЛЬНЫЙ РЕКОМЕНДОВАННЫЙ ШОВ МЕЖДУ ПЛИТКАМИ



CATEGORIE DI RESISTENZA ALLO SCIVOLAMENTO

SLIP RESISTANCE GROUPS
CATEGORIES DE RESISTANCE AU GLISSEMENT
RUTSCHHEMMUNGSKATEGORIEN
КАТЕГОРИИ СОПРОТИВЛЕНИЯ СКОЛЬЖЕНИЮ ПРИ ХОЖДЕНИИ

LIVELLO DI STONALIZZAZIONE

COLOR SHADE VARIATIONS
VARIATION DES NUANCES DE COULEUR
VARIATION DER FARBNUANCEN

V1

ASPETTO UNIFORME

UNIFORM APPEARANCE
ASPECT UNIFORME
EINHEITLICHES AUSSEHEN

V2

LIEVE STONALIZZAZIONE

SLIGHT VARIATION
LEGERE VARIATION
GERINGE ABWEICHUNG

V3

MODERATA STONALIZZAZIONE

MODERATE VARIATION
VARIATION MODEREE
MASSIGE ABWEICHUNG

V4

INTENSA STONALIZZAZIONE

SUBSTANTIAL VARIATION
VARIATION INTENSE
STARKE ABWEICHUNG

00 ●

FASCIA DI PREZZO ARTICOLI VENDUTI A MQ.

PRICE RANGE FOR ITEMS SOLD PER SQUARE METRE
FOURCHETTE DE PRIX DES ARTICLES VENDUS AU M²
PREISKLASSE PRO QM VERKAUFTE ARTIKEL
ЦЕНОВОЙ СЕГМЕНТ ИЗДЕЛИЙ, ПРОДАВАЕМЫХ ЗА КВ.М

00 ▲

FASCIA DI PREZZO ARTICOLI VENDUTI A PEZZO

PRICE RANGE FOR ITEMS SOLD PER UNIT
FOURCHETTE DE PRIX DES ARTICLES VENDUS A LA PIECE
PREISKLASSE PRO STÜCK VERKAUFTE ARTIKEL
ЦЕНОВОЙ СЕГМЕНТ ИЗДЕЛИЙ, ПРОДАВАЕМЫХ ПОШТУЧНО

00 ☐

PEZZI PER SCATOLA

PIECES PER BOX
PIECES PAR BOITE
STÜCK JE KARTON
ШТУК В КОРОБКЕ



DISPONIBILE SU RICHIESTA

AVAILABLE ON REQUEST
DISPONIBLES SUR DEMANDE
VERFÜGBAR AUF WÜNSCH
ПОСТАВЛЯЕТСЯ ПОЗАКАЗУ



SAIME CERAMICHE

Via Giardini, 24

41042 Fiorano Modenese MO Italy

LAT: 44.5409960 (44° 32' 27.586")

LNG: 10.8615504 (10° 51' 41.581")

Tel. +39 0536 869611

Fax +39 0536 843823

+39 0536 830313

+39 0536 832533

+39 0536 869681

saime@riwal.it

www.saimeceramiche.com



NUOVA RIWAL CERAMICHE s.r.l.

Sede legale: Via Giardini, 24 - 41042 Fiorano Modenese MO Italy

Sede amministrativa: Via Statale, 467 - 41013 Casalgrande RE Italy

Tel. +39 0536 869411

Fax +39 0536 837321

info@riwal.it

www.riwal.it



Ceramics of Italy